

High Pressure Filters SF



Local solutions for individual customers worldwide



Distributor

Walter Stauffenberg GmbH & Co. KG

P.O.Box 1745 · D-58777 Werdohl
Im Ehrenfeld 4 · D-58791 Werdohl
Tel. : + 49 (0) 2392 916-0
Fax: + 49 (0) 2392 2505
e-mail: sales@stauff.com
Internet: http://www.stauff.com

Oil Solutions

PO Box 653 Castlemaine 3450

Phone 0421 336 009

Fax 03 9012 4332

International

Phone 61 0421 336 009

Fax 61 3 9012 4332

sales@oilsolutions.com.au

www.oilsolutions.com.au

Australia:

Stauff Corporation (Pty.) Ltd.
P.O. Box 227
24-26 Doyle Avenue, Unanderra
Wollongong, N.S.W.
AUS-2526 Unanderra
Tel. : + 61 2 42 71 18 77
Fax: + 61 2 42 71 84 32

Brazil:

Stauff Brasil Ltda.
Avenida Gupe 10.767
Galpa" o 2, Bloco A
WT – Empresarial Parque Castello Branco
BRA-Barueri – SP
CEP: 06422-120
Tel: +55 1147899020
Fax: +55 1147899021

China:

Stauff International Trading (Shanghai) Co., Ltd.
Shangdian Mansion, Pudong
331, Binzhou Road
CHN-200126 Shanghai
Tel. : + 86 21 58 45 65 60
Fax: + 86 21 58 45 66 80

France:

Stauff s.a.
230, Avenue du Grain d'Or
Z.I. de Vineuil-Blois Sud
F-41354 Vineuil-cedex
Tel. : + 33 2 54 50 55 50
Fax: + 33 2 54 42 29 19

India:

Stauff India Pvt. Ltd.
Gat. No. 2340
Pune-Nagar Road, Wagholi
IND-Pune - 412207
Tel. : + 91 20 705 19 90
Fax: + 91 20 705 19 89

Italy:

Stauff Italia s.r.l.
Via Pola 21/23
I-20034 Birone di Gussano
Tel. : + 39 0362 31 21 13
Fax: + 39 0362 33 55 36

Japan:

Ohtsuka Tec. Co. Ltd.
1-7-19 Minami Shinagawa
Shinagawa-Ku
JPN-Tokyo 140
Tel. : + 81 3 34 72 12 01
Fax: + 81 3 34 72 12 09

Canada:

Stauff Canada Ltd.
866 Milner Avenue
CAN-Scarborough, Ontario M1B 5N7
Tel. : + 1 416 282 46 08
Fax: + 1 416 282 30 39

USA:

Stauff Corporation
7 Wm. Demarest Place
USA-Waldwick, N.J. - 07463
Tel. : + 1 201 444 78 00
Fax: + 1 201 444 78 52

United Kingdom:

Stauff UK
332, Coleford Road
Darnall
GBR-Sheffield, S 9 5 P H
Tel. : + 44 1142 518 518
Fax: + 44 1142 518 519

Stauff Filtration Technology

Stauff Filtration Technology offers a complete range of filtration products and services that will provide the system designer or user with the highest level of contamination control demanded by today's most sophisticated applications. Products include pressure filters, return line filter elements, spin on filters suction strainers, and filler breathers for various hydraulic, lubrication and fuel oils.

Stauff has the technical expertise to provide superior filter element designs for the Stauff original filter housings and also for the interchange element market. Stauff manufactures more than 10,000 different elements. Many of these are designed to fit into filter housings produced by other companies while maintaining or surpassing the original performance.

The "Stauff Contamination Control Program" includes the diagnostic services including fluid sampling and laser particle counting products needed to monitor the system contamination level. Stauff, through its global network of wholly owned companies and technically qualified distributors, is ideally placed to assist its customers in the total contamination process providing a well balanced filtration solution.

Technical Data

STAUFF high pressure filters are designed for in-line hydraulic applications, with a maximum operating pressure of 420 bar (6000 PSI). Used together with STAUFF filter elements, a high efficiency of contaminant removal is assured. The high dirt holding capacity of the elements ensures long service life and, as a result, reduced maintenance costs.



Technical Specification

Construction	In-line assembly, with threaded mounting holes on top of head	Reverse flow valve	Allows reverse flow through the filter head without backflushing the element
Filter head	Spheroidal graphite cast iron	Non-return valve	Prevents draining of the delivery line during element change
Filter bowl	Cold drawn steel	Multi-function valve	Forward by-pass, reverse flow capability, and non return valve opening pressure 6 ^{+0,5} bar (87 ^{+7,25} PSI) Δp all in one valve
Seals	O-Rings NBR (Buna-N®) FPM (Viton®) EPDM (Ethylene-propylene), support ring PTFE	Clogging indicators	standard actuating pressure 5 ^{-0,5} bar (72 ^{-7,25} PSI)Δp execution indicators: visual, electrical and visual-electrical (24 V, 110 V, 220 V versions) other actuating pressures on request
Port connections	BSP, NPT, SAE "O"-Ring thread or SAE Code 62 flange	Filter elements	Specifications see page 9
Operating pressure	max 420 bar (6000 PSI)	Media	Mineral oils, other fluids on request
Proof pressure	630 bar (9100 PSI)		
Burst pressure	>1260 bar (18250 PSI)		
Temperature range	-10°C up to +100°C (14°F up to 212°F)		
By-pass valve	Allows unfiltered oil to by-pass the contaminated element once the opening pressure has been reached		

Dimensions

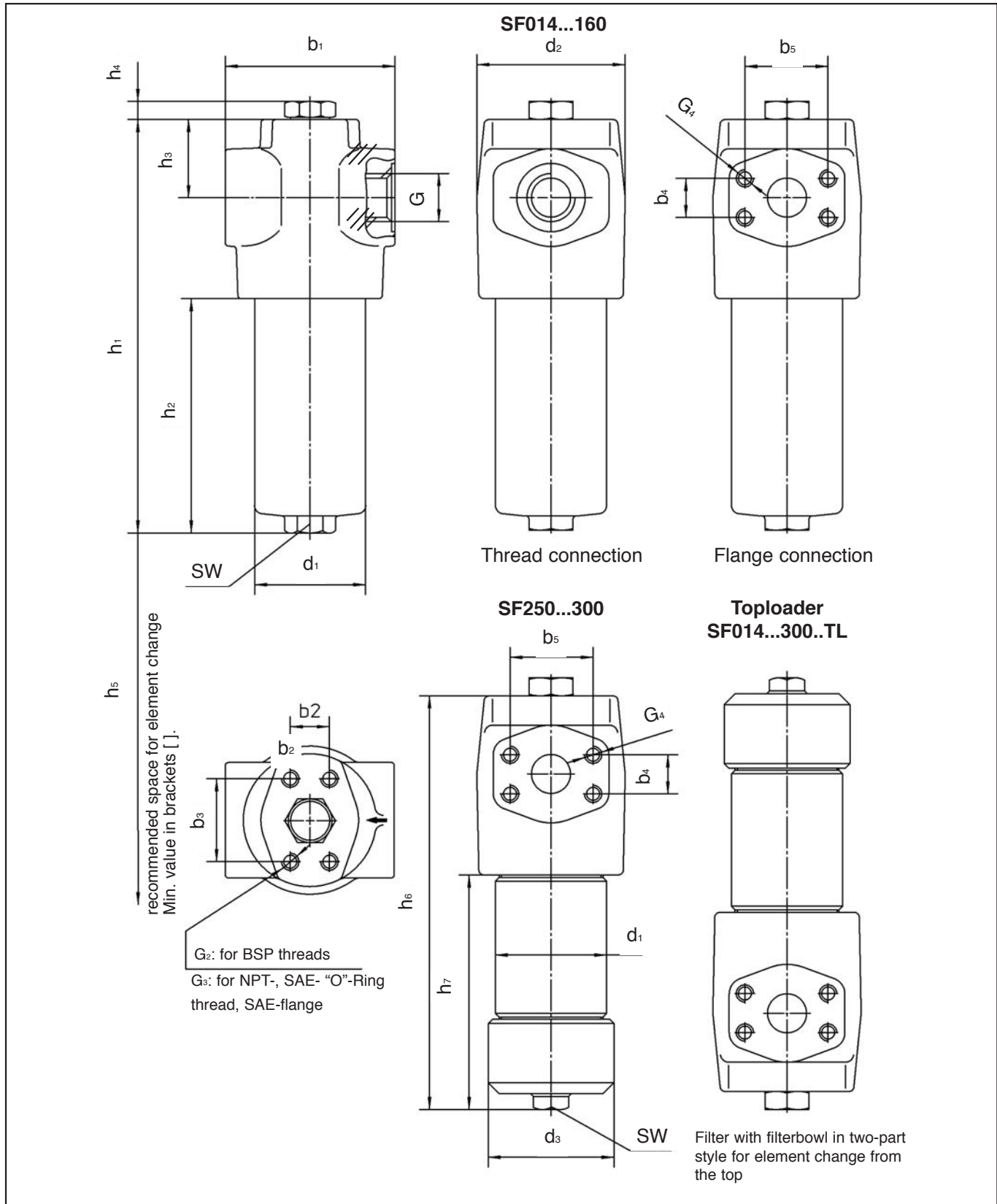

Dimensions in mm (inch)

Dimensions

Filter Size	Thread connection G				Weight including elements			
	BSP	NPT	SAE- "O"-Ring thread	SAE - flange 6000 PSI	with bowl in one-part style		with bowl in two-part style	
					kg	lbs	kg	lbs
SF014	G 3/4	3/4"	1 1/16-12 UN	3/4"	5,3	11,7	5,9	13
SF030					6,2	13,7	6,9	15,2
SF045	G 1 1/4	1 1/4"	1 5/8-12 UN	1 1/4"	10,3	22,7	12,2	26,9
SF070					12	26,5	13,7	30,2
SF125					16,3	35,9	20	44,1
SF090	G 1 1/2	1 1/2"	1 7/8-12 UN	1 1/2"	27	59,9	32	70,5
SF160					35,5	78,3	39,3	86,5
SF250					-	-	49	108
SF300					-	-	57,3	126,3

Filter Size	Dimensions														
	with filterbowl in one-part style Type SF									with filterbowl in two-part style Type SF...-TL					
	b ₁	d ₂	h ₃	h ₄	d ₁	h ₁	h ₂	h ₅	SW	d ₁	d ₃	h ₆	h ₇	h ₅	SW
SF014	104	83	48	12,5 (0,492)	68 (2,677)	188 (7,402)	78 (3,071)	100 [85] (3,937 [3,347])	27 (1,063)	70 (2,756)	84 (3,307)	190 (7,48)	80 (3,15)	65 (2,559)	27 (1,063)
SF030	(4,095)	(3,268)	(1,89)			254 (10)	144 (5,670)	170 [85] (6,693 [3,347])				256 (10,079)	146 (5,748)	130 (5,118)	
SF045	140 (5,512)	116 (4,567)	49,5 (1,949)	12,5 (0,492)	95 (3,740)	239 (9,409)	103 (4,055)	140 [120] (5,512 [4,724])	32 (1,26)	101,6 (4)	115 (4,528)	241 (9,488)	103 (4,055)	100 (3,937)	32 (1,26)
SF070						298 (11,732)	161 (6,339)	200 [120] (7,874 [4,724])				300 (11,811)	163 (6,417)	160 (6,299)	
SF125						483 (19,106)	343 (13,504)	380 [120] (14,961 [4,724])				485 (19,095)	344 (13,543)	340 (13,386)	
SF090	178 (7,008)	159 (6,260)	72 (2,835)	12,5 (0,492)	130 (5,118)	323 (12,717)	148 (5,827)	190 [150] (7,48 [5,906])	36 (1,417)	133 (5,236)	155 (6,102)	329,5 (12,972)	154,5 (6,083)	120 (4,724)	36 (1,417)
SF160						494 (19,449)	319 (12,559)	360 [150] (14,173 [5,906])				500,5 (19,705)	325,5 (12,815)	290 (11,417)	
SF250						not available						656,5 (25,847)	481,5 (18,957)	425 (16,732)	
SF300						not available						821,5 (32,343)	646,5 (25,453)	590 (23,228)	

Filter Size	Dimensions Mounting Flange								Dimensions SAE-Flange 6000 PSI					
	New Standard Style (for new engineering/constructions) TH				Old Style (running out, not for new engineering/constructions) T									
	b ₂	b ₃	G ₂	G ₃	b ₂	b ₃	G ₂	G ₃	b ₄	b ₅	G ₄			
SF014	32 (1,26)	56 (2,205)	M6x9	1/4 - 28 UNF x 0.354	23,8 (0,937)	50,8 (2)	M10x15	3/8 -16 UNC x 0.591	23,8 (0,937)	50,8 (2)	3/8-16 UNC			
SF030														
SF045	35 (1,244)	85 (2,626)	M10x15	3/8 - 24 UNF x 0.591	31,6 (1,378)	66,7 (3,347)	M14x20	1/2-13 UNC x 0.787	31,6 (1,244)	66,7 (2,626)	1/2-13 UNC			
SF070														
SF125														
SF090	60 (1,445)	115 (3,126)	M12x20	1/2 - 20 UNF x 0.787	36,7 (2,362)	79,4 (4,528)	M16x20	5/8-11 UNC x 0.787	36,7 (1,445)	79,4 (3,126)	5/8-11 UNC			
SF160														
SF250														
SF300														

Dimensions in mm (inch)

Valves

The optional valves are fitted as an insert in the filter head and incorporate the spigot on which the element seals. The valve is selected to suit the filter application.

HV-O **Non-by-pass standard insert** without any valve function. Element collapse rating should be higher than system pressure

HV-B **By-pass valve** which allows oil to bypass the element when the differential pressure across the element reaches $6^{+0,5}$ bar ($87^{+7,25}$ PSI). (Other pressure settings available on request). The opening pressure should be higher than the Δp setting of an optional clogging indicator. Low collapse (30 bar / 435 PSI Δp) elements are normally used with this valve.

HV-R **Reverse flow valve** is used in systems where there is flow in reverse through the filter. It allows reverse flow without back-flushing the element but does not filter in the reverse direction. High collapse elements (210 bar / 3045 PSI Δp) are normally used with this valve.

HV-N **Non-return valve**
This valve prevents the oil in the delivery line from draining out while the filter is being serviced. Because there is no by-pass, the element collapse rating should be higher than system pressure.

HV-M **Multi-function valve**
This valve combines the by-pass, the reverse flow and the non-return functions in one unit. The by-pass opening pressure is $6^{+0,5}$ bar / $87^{+7,25}$ PSI Δp with other opening pressures available on request. The opening pressure should be higher than the Δp setting of an optional clogging indicator.

HV - M 014/030 /X

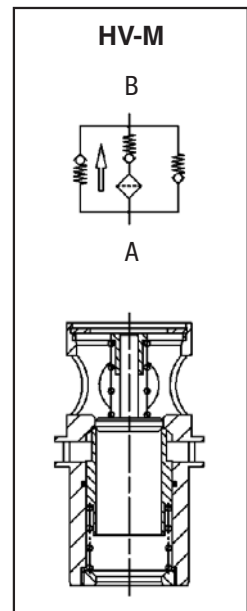
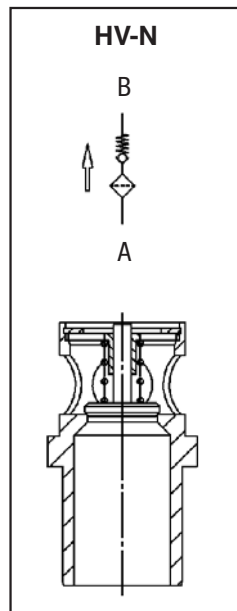
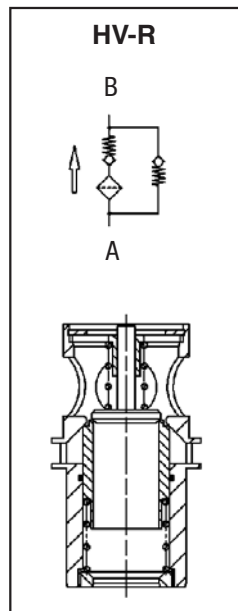
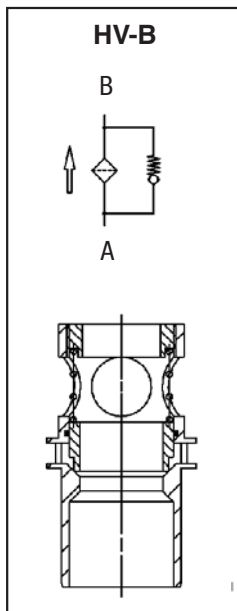
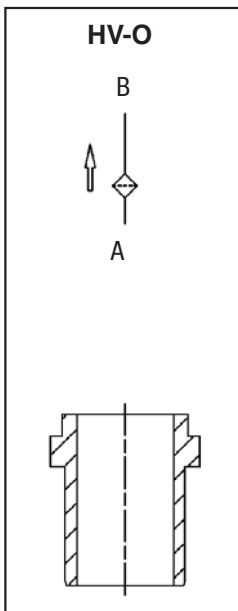
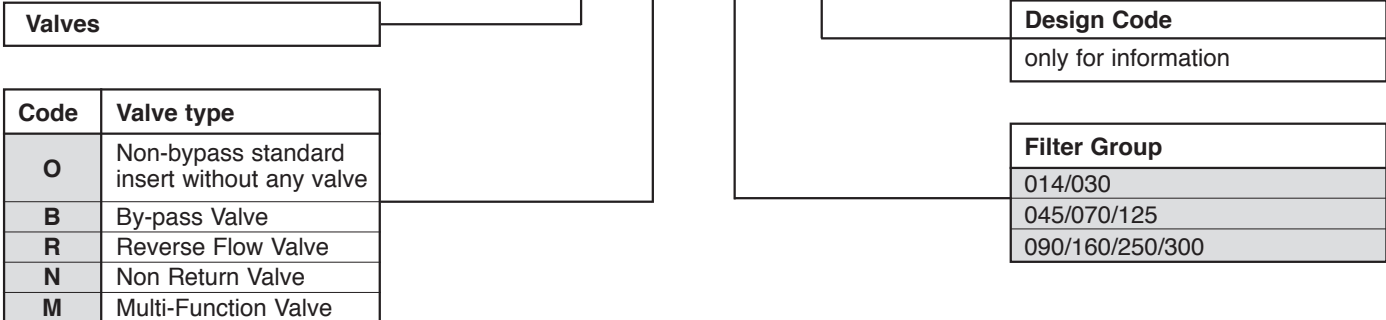

Flow characteristics of the valves see page 10

Clogging Indicators

STAUFF pressure filters have a range of clogging indicators available. If no indicator is specified, the port is sealed by a plug (HI-O). The clogging indicators are actuated by the differential pressure (Δp) across the element. The special piston design minimizes the effects of peak pressures in the system. An optional thermostatic lockout (thermo-stop) is available to prevent false indication under cold start conditions. Fluid temperature must be at least 20°C (68°F) for the indicator to function.

Technical Specification

Body	Stainless steel
Seals	NBR (Buna-N®), FPM (Viton®), EPDM Seal 18,5x23,9x2 (0,728x 0,941x 0,079) O-Ring 15,5x1,5 (0,61x0,059)
Thread	1/2" BSP
Differential pressure setting	5,0,5 bar (72,725 PSI) (other settings on request)
Electrical	Standard DIN appliance plug, Screwed cable gland PG11, protection rating (DIN40050) IP65, both NO and NC contacts are available in the switch, rated capacity: see chart

The visual clogging indicators are available in the following configurations :

Manual reset	The indicator continues to display the clogged signal even through the Δp may have fallen. Pressing the plastic cover down will reset the indicator.
Automatic reset	The clogged signal will disappear when the Δp drops below the setting for the indicator.

Electrical and visual-electrical clogging indicators are only available with automatic reset.

HI - P T 220 B - 5,0B /X

Clogging Indicator			Design Code
Code	Execution		only for information
O	plug		Differential pressure setting
A	visual, automatic reset		25P 25 PSI (1,72 bar)
V	visual, manual reset		2,0B 2,0 bar (29 PSI)
E	electrical		3,0B 3,0 bar (43,5 PSI)
P	visual-electrical		5,0B 5,0 bar (72,5 PSI) (Standard)
			7,0B 7,0 bar (101,5 PSI)
Thermostop			others on request
	without Thermostop		
T	with Thermostop		
Voltage (only for Code P)			Sealing Material
24	24 V		B NBR (Buna®)
110	110 V		V FPM (Viton®)
220	220 V		E EPDM

HI-O	HI-A HI-A	HI-E	HI-P	Rated Capacity HI-E and HI-P Alternating current 250V AC 5 Amps Direct current: see table below												
				<table border="1" style="width: 100%;"> <thead> <tr> <th>Voltage V</th> <th>Resistive Load Amps</th> <th>Inductive Load Amps</th> </tr> </thead> <tbody> <tr> <td>24</td> <td>8,00</td> <td>7,00</td> </tr> <tr> <td>110</td> <td>0,50</td> <td>0,20</td> </tr> <tr> <td>220</td> <td>0,25</td> <td>0,10</td> </tr> </tbody> </table>	Voltage V	Resistive Load Amps	Inductive Load Amps	24	8,00	7,00	110	0,50	0,20	220	0,25	0,10
Voltage V	Resistive Load Amps	Inductive Load Amps														
24	8,00	7,00														
110	0,50	0,20														
220	0,25	0,10														
<p>N.B. High voltage peaks occur when inductive loads are switched off. Protective circuitry should be employed to reduce contact burnout.</p>																

Ordering Code Filter Housings

SF 014 ... V - TH B / B / PT 220 / TL /2

Filter type	SF
-------------	----

Group		
Size	Flow *	
	l/min	GPM
014	60	14
030	110	30
045	160	45
070	240	70
090	330	90
125	440	125
160	660	160
250	990	250
300	1320	300

Note: Exact flow will depend on filter element selected. Consult Technical data on page 10 & 11

for complete filters:
identification filter material + micron rating code (see ordering code filter elements below)

Seal material	
B	NBR (Buna®)
V	FPM (Viton®)
E	EPDM

other seal materials on request

Connecting Flange	
TH	Type T (new standard)
(T)	Type T

see table page 5 dimensions connecting flange
Type T is running out, please use only type TH for new engineering/constructions

Design Code
only for information

Style filterbowl	
with bowl in one-part style	
TL	Toploader. with bowl in two-part style

Voltage (only for code P)	
24	24 V
110	110 V
220	220 V

Thermostop	
without Thermostop	
T	with Thermostop

Clogging indicator	
without clogging indicator	
A	visual, with autom. reset
V	visual, with manual reset
E	electrical
P	visual-electrical

Valve	
O	without valve
B	By-pass valve
R	Reverse flow valve
N	Non return valve
M	Multi-function valve

Code	Connection style	Group							
		014	030	045	070	125	090	160	250
B	BSP	G ^{3/4}		G1 ^{1/4}		G1 ^{1/2}			
B1	BSP	G1		G1 ^{1/2}		-			
N	NPT	3/4"		1 1/4"		1 1/2"			
U	SAE-"O"-Ring thread	1 1/16 - 12		1 3/8 - 12		1 7/8 - 12			
F	SAE-flange (3000 PSI)	3/4"		1 1/4"		1 1/2"			
F1	SAE-flange (3000 PSI)	1"		-		2"			
G	SAE-flange (6000 PSI)	3/4"		1 1/4"		1 1/2"			

Other port connections on request. Flanges do not belong to the scope of supply!

Ordering Code Filter Elements

SE-014 G 10 V /X

Series	SE
--------	----

Group
according to filter housing

Filter material			Micron ratings available
Code	Material	max Δp _{collapse}	
A	Stainless fiber	210 bar (3045 PSI)	03, 05, 10, 20
C	Polyester fiber	210 bar (3045 PSI)	
N	Filterpaper	30 bar (435 PSI)	
G	Inorganic glass fiber	30 bar (435 PSI)	
H	Inorganic glass fiber	210 bar (3045 PSI)	
B, S	Stainless mesh	30 bar (435 PSI)	10, 25, 40, 60, 100
T, W	Stainless mesh	210 bar (3045 PSI)	

*collapse / burst resistance as per ISO 2941

Bold type identifies preferred material

Design Code
only for information

Seal material	
B	NBR (Buna®)
V	FPM (Viton®)
E	EPDM
other seal materials on request	

Micron rating	
03	3 μm
05	5 μm
10	10 μm
20	20 μm
25	25 μm
40	40 μm
60	60 μm
100	100 μm
200	200 μm
500	500 μm
other micron ratings on request	

Replacement Filter Elements for SF Series

STAUFF replacement filter elements for SF series filters are manufactured in the common filter materials such as stainless fiber, stainless mesh, paper and inorganic glass fiber. As standard all replacement elements series SF have tin plated steel parts for use with aggressive media such as water glycol, other materials available on request. All STAUFF replacement elements comply with quality specifications in accordance with international standards.



SE-014 G 10 V /X

Series SE

Group
according to filter housing

Filter material			Micron ratings available
Code	Material	max Δp collapse	
A	Stainless fiber	210 bar (3045 PSI)	03, 05, 10, 20
C	Polyester fiber	210 bar (3045 PSI)	
N	Filterpaper	30 bar (435 PSI)	
G	Inorganic glass fiber	30 bar (435 PSI)	
H	Inorganic glass fiber	210 bar (3045 PSI)	
B, S	Stainless mesh	30 bar (435 PSI)	10, 25, 40, 60, 100
T, W	Stainless mesh	210 bar (3045 PSI)	

*collapse / burst resistance as per ISO 2941

Bold type identifies preferred material

Design Code
only for information

Seal material	
B	NBR (Buna®)
V	FPM (Viton®)
E	EPDM
other seal materials on request	

Micron rating	
03	3 μm
05	5 μm
10	10 μm
20	20 μm
25	25 μm
40	40 μm
60	60 μm
100	100 μm
200	200 μm
500	500 μm
other micron ratings on request	

Flow Characteristics of Pressure Filters

The following characteristics are valid for mineral oils with a density of 0,85 kg/dm³ and the kinematic viscosity of 30 mm²/s. The characteristics have been determined in accordance to ISO 3968.

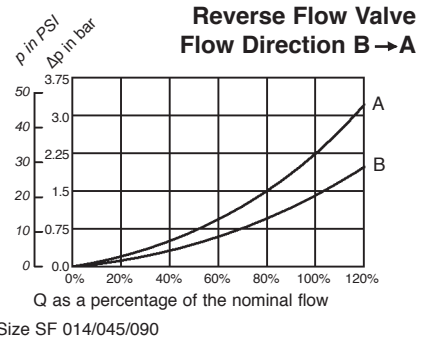
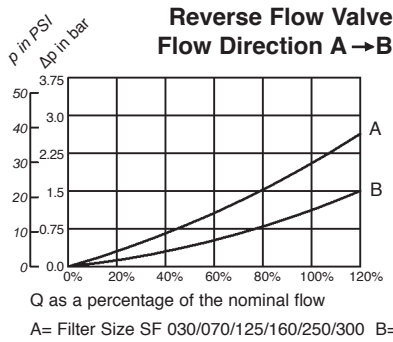
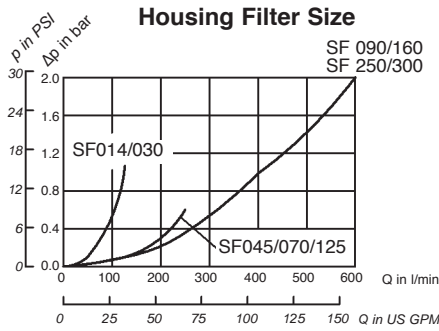

Characteristics of the multi-function valve are approximately 15% higher than those of the reverse flow valve

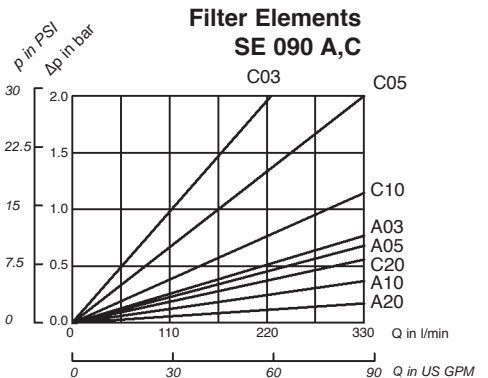
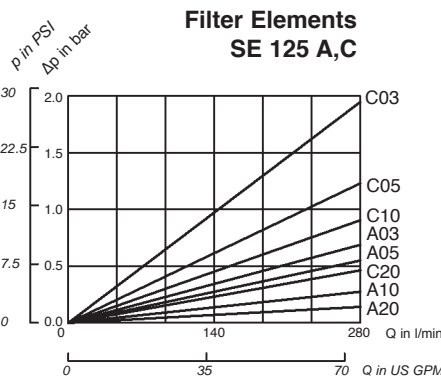
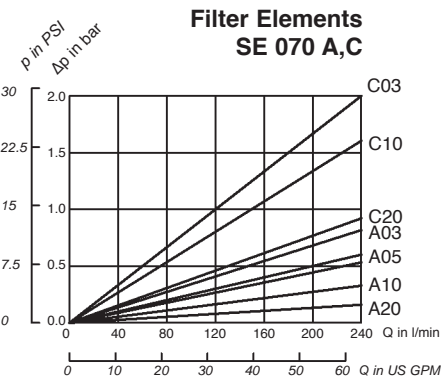
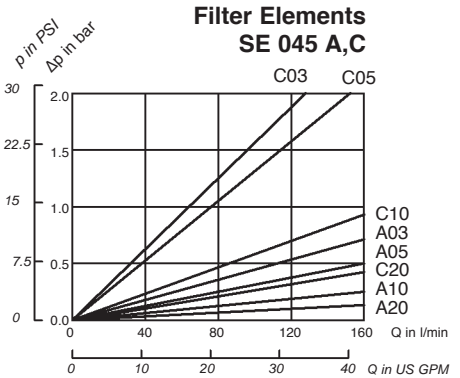
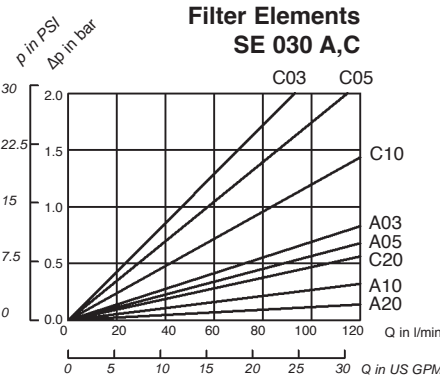
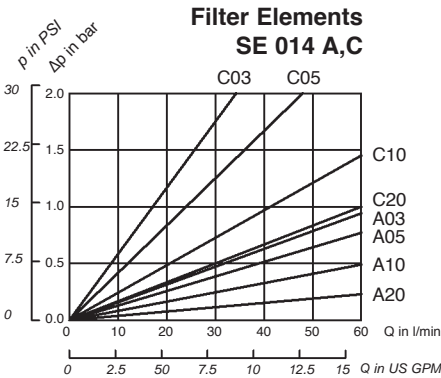
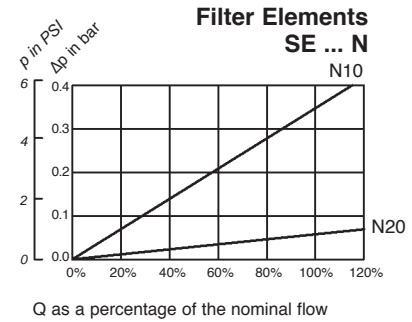
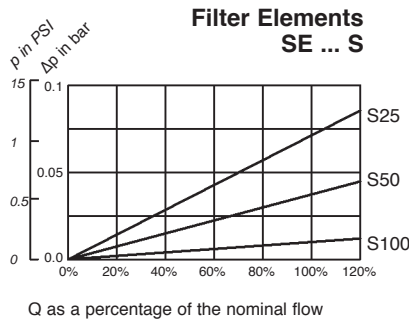
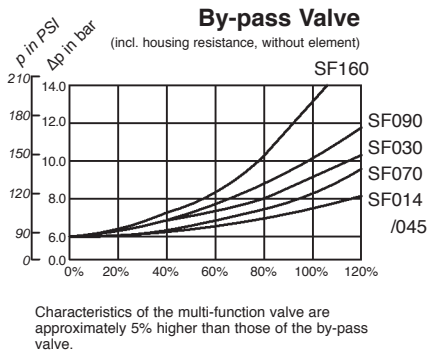

Flow Characteristics of Pressure Filters

The following characteristics are valid for mineral oils with a density of 0,85 kg/dm³ and the kinematic viscosity of 30 mm²/s. The characteristics have been determined in accordance to ISO 3968.

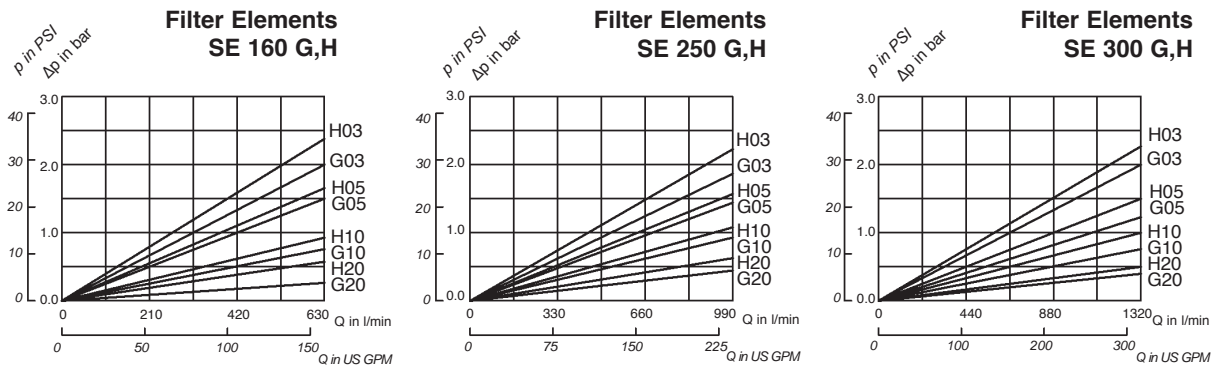
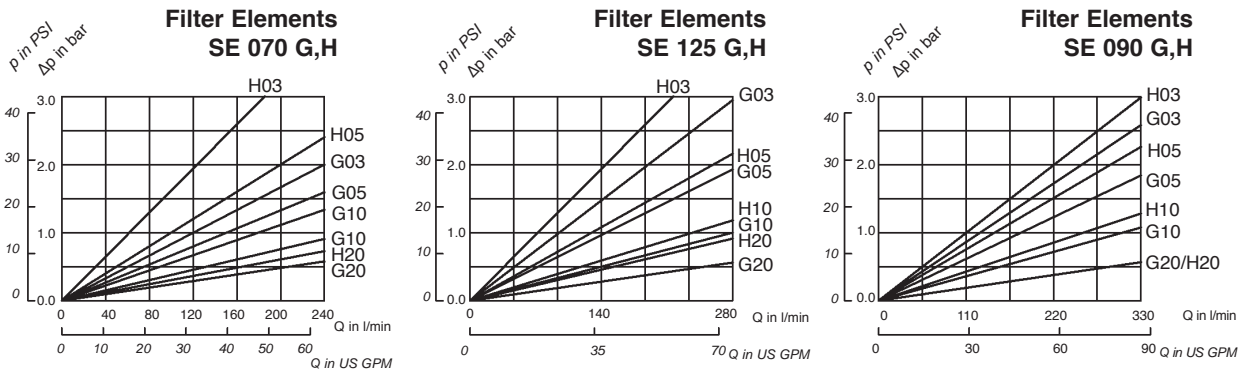
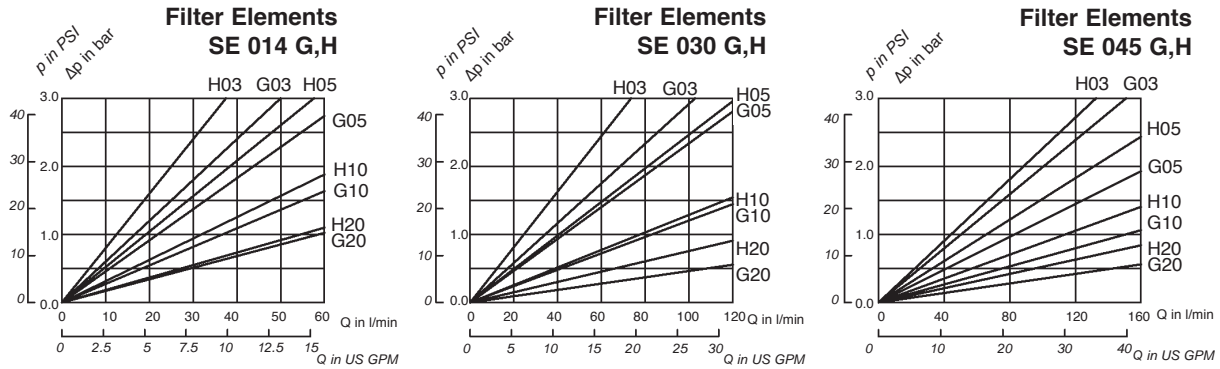
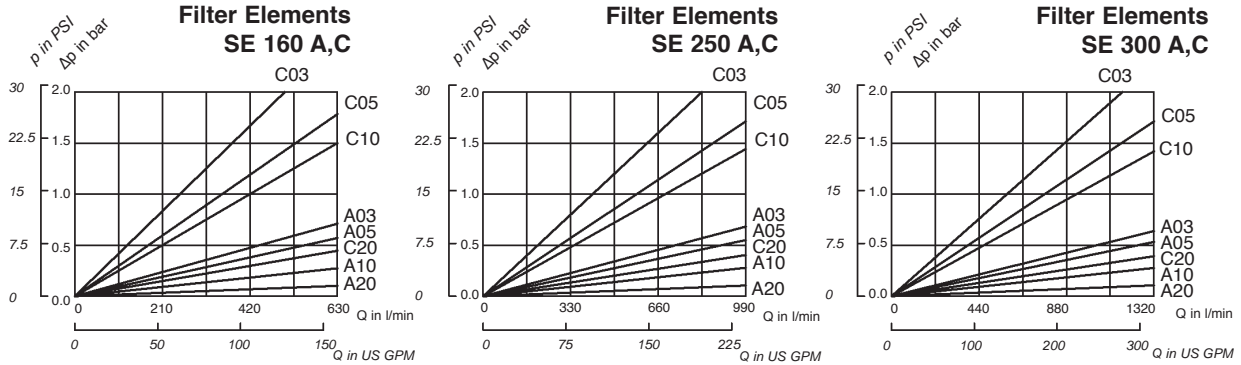

Oil Solutions Product Range

FILTERS:



- ◆ Hydraulic filtration systems
- ◆ High pressure filters for in-line mounting: maximum working pressure: 630 bar
- ◆ Return line tank top filters: maximum working pressure: 16 bar
- ◆ Replacement filter elements:
- ◆ Compatible quality and dimensional interchange to suit most filter makes
- ◆ Filter materials: Glass fibre, Metal fibre, Polyester fibre, Wire mesh, Paper

HYDRAULIC ACCESSORIES:

Components for the construction of tanks and power units and mobile hydraulics



- ◆ Level gauges Level
- ◆ Air filters
- ◆ Filler breathers
- ◆ Desiccant air breathers
- ◆ Spin-On - Filters
- ◆ Suction strainers & Diffusers
- ◆ Temperature switches
- ◆ Throttle and shut-off valves
- ◆ Check valves
- ◆ Gauge isolator valves
- ◆ Flow indicators
- ◆ Stainless steel pressure gauges
- ◆ Flow control valves & Ball valves

TEST EQUIPMENT:



- ◆ Pressure test systems
- ◆ Venting and sampling of liquid and gas pressure systems nominal working pressure: 630 bar maximum
- ◆ Test couplings and accessories:
- ◆ Adaptation threads, Plug-in system
- ◆ Test hoses:
- ◆ Digital measuring device for:
- ◆ Working pressure
- ◆ Differential pressure
- ◆ Temperature
- ◆ Flow ,RPH
- ◆ Data output via PC or printer

CLAMPS:



- ◆ Clamping systems for tubes, hoses, pipes, cables and components
- ◆ Tube fastening system in accordance with DIN 3015
- ◆ Dimensional range from 6 to 800 mm
- ◆ Different materials available U-Bolt and DIN clamps
- ◆ Angle Adjustment Clamps
- ◆ Special clamps and supports:

SPECIALIST FILTRATION EQUIPMENT:

Oil Solutions Design, Manufacture, Install & Service

Manufacture a Range of Filtration Equipment:

- ◆ Filter Trolleys, Drum Trolleys
- ◆ Bypass Filtration, Off line Filtration.
- ◆ Provide Economical Oil Service.

Oil Solutions was set up to provide quality economical solutions for industry, reducing production costs by improving oil cleanliness through careful servicing of reservoirs and improving oil filtration were necessary. We are the Oil Service Specialists



Efficient Filtration Systems

Email sales@oilsolutions.com.au Web www.oilsolutions.com.au