

Innovation Papers



OIL SOLUTIONS

PO Box 38
Strathfieldsaye, VIC, 3551
1800 OIL SOL
1800 645 765

sales@oilsolutions.com.au

www.oilsolutions.com.au

"For All Your Hydraulic Needs"

Solenoid Cartridges





1800-OILSOL
1800-645765

<https://oilsolutions.com.au/>

sales@oilsolutions.com.au



1800-OILSOL
1800-645765

<https://oilsolutions.com.au/>

sales@oilsolutions.com.au



ABOUT US



An Italian story

There used to be strawberry fields...

And then in 1974 this largely rural area on the outskirts of Modena became the location of a factory making parts for hydraulic directional valves, a business started in 1966 by our Dad, Orlando, in his garage.

His introduction of overcentre valves to the Italian market made him a pioneer in this field of hydraulic valve manufacture.

From him we learned that through entrepreneurship one can create added value and make a real contribution to the heritage of the local community.

He cared about people and was one of the first Italian business owners to employ health and safety measures in his workshops.

That is our heritage. Our future lies in the hands of the talented engineers and designers who work for our company. They strive to enhance the quality and performance of our range of products using their technical expertise as well as their creative and innovative skills .

We work as a team to create a better future.

Michele Storci

Operations Director

Christian Storci

Managing Director



A COMPLETE SOLENOID VALVE RANGE

To meet the needs of all customers

Solenoid operated valves employ electrical power to control the flow or pressure of oil.

Atlantic Fluid Tech manufactures a wide range of solenoid cartridges.

They not only fit into **SAE standard cavities** but also certain **special ones**, as well, affording the end user maximum interchangeability with market standards.

The range includes **2, 3, 4 and 5-way cartridges, analogue (on/off) and proportional control.**

Direct acting, pilot and pneumatically operated valves are available along with **manual overrides, proximity sensors and standard or ATEX explosion proof tubes.**

They can operate as pressure control, directional control and flow control valves.



ATLANTIC FLUID TECH 2-WAY ON-OFF TECHNOLOGY

The new Benchmark for the industry

In 1973 the first mobile phone was invented, changing the way we communicate for ever. It took a decade to start mass-production and the first models were

- bulky
- had high energy consumption
- low storage memory and
- call quality was quite poor.

Then in the 90's the smartphone was introduced which at first improved things and then fixed the issues.

Similarly the solenoid cartridge system was originated in the 50's. Up to that time the technology offered manual control of mobile and industrial machinery. Although the new valves offered remote control using an electrical signal, the internal design philosophy didn't change much and is in fact still predominant in the market today.

Now, Atlantic Fluid Tech is introducing **a new design concept** for the 2-way, on-off pilot operated cartridge valve which offers

- **a more compact design**
- **energy-savings**
- **high pressure operation**
- **lower pressure drops at all flow ratings.**

You wouldn't keep using an old mobile phone, so why use old valve technology?



CAN YOU SEE THE DIFFERENCE?

Patent Pending System no. WO/2013/014625

The benefits of the new Atlantic technology for solenoid cartridge valves are distinctive and substantial.

The internal components have been designed to achieve a **50% higher flow rating** compared to competitors' valves in the same size cavity. Therefore an Atlantic size 08 cartridge can be chosen instead of a size 10 to get a 60 l/min (16 gpm) flow rating.

Inversely the **Pressure Drop generated is half** that of comparable competitors' products for a given flow rate. Specifically if you consider an Atlantic size 08 cartridge flowing 40 l/min (10.50 gpm), the pressure drop will only be 5 bar (72 psi) which can result in a 50% energy saving.

Depending on their priority a customer can choose compactness or energy saving.

This is an unprecedented result that will shake up the hydraulic market, especially as competitor brands mostly use long-established designs and technologies.

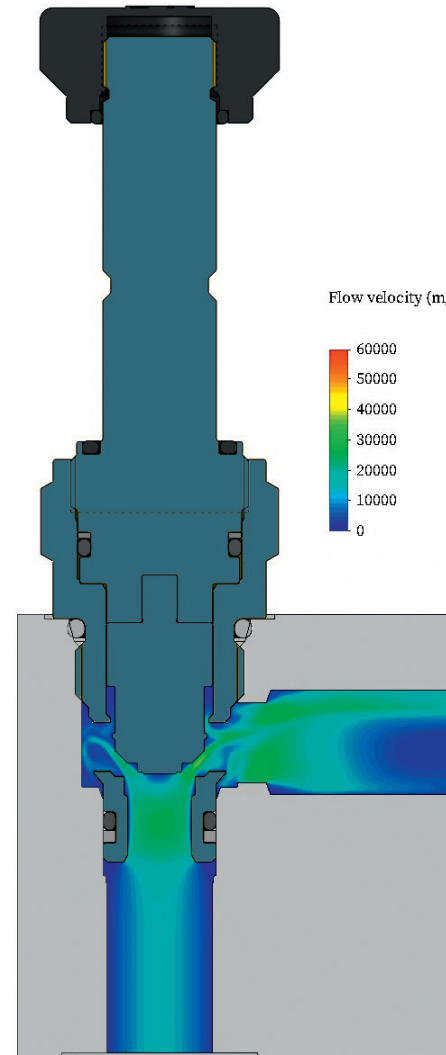

Atlantic Fluid Tech patented technology

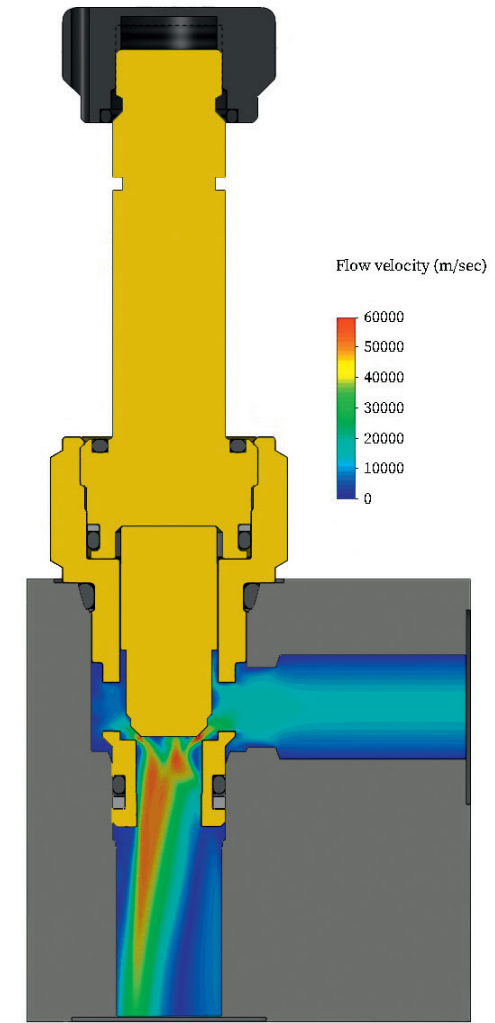

Competitors' valve



1800-OILSOL
1800-645765



<https://oilsolutions.com.au/>

sales@oilsolutions.com.au

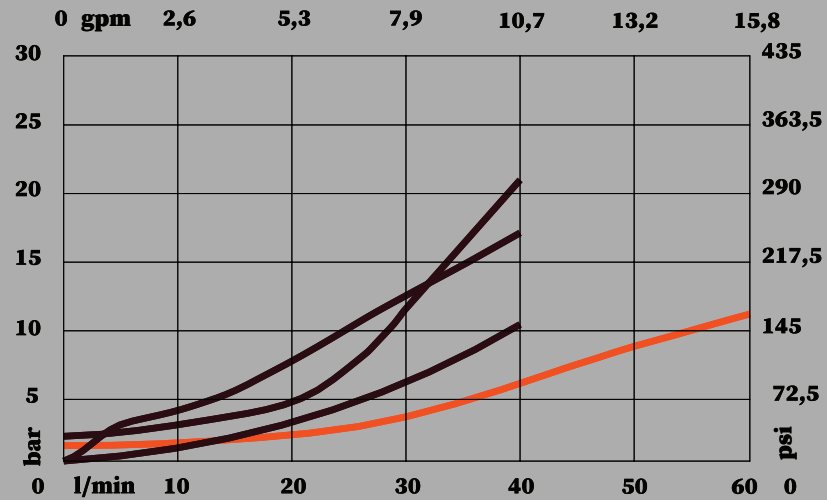

BETTER PERFORMANCE

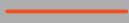
The performance curves shown in the illustration reveal the performance advantages of the Atlantic valves compared to competitors' products.

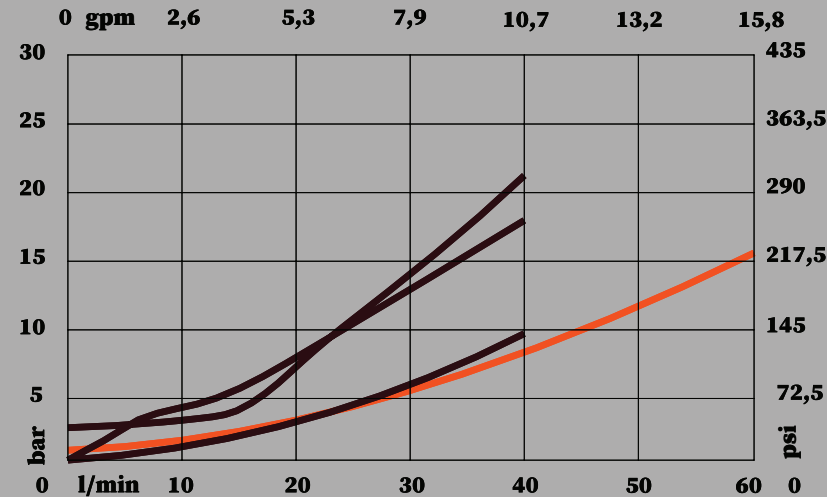
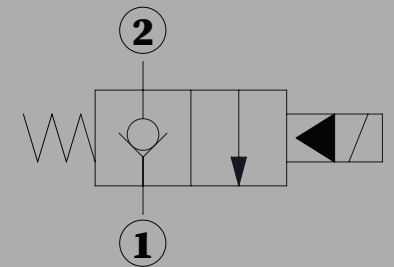

Δp 2 > 1: Energized	
	AFT
	Other market references



Δp 1 > 2: De-Energized	
	AFT
	Other market references



1800-OILSOL
1800-645765

<https://oilsolutions.com.au/>

sales@oilsolutions.com.au



Special tubes have been designed to work reliably **at the highest pressures**. The employment of non-welded construction and the use of high-strength materials have produced valves that can work at **500 bar (7200 psi)** with a **burst pressure of 1300 bar (18800 psi)**.



One of the advantages of a cartridge system is that it can use industry standard cavities. The unique benefit of the Atlantic valves is that they provide **a higher nominal flow rating for any given cavity size** enabling a smaller size to be chosen, thus saving space and cost.

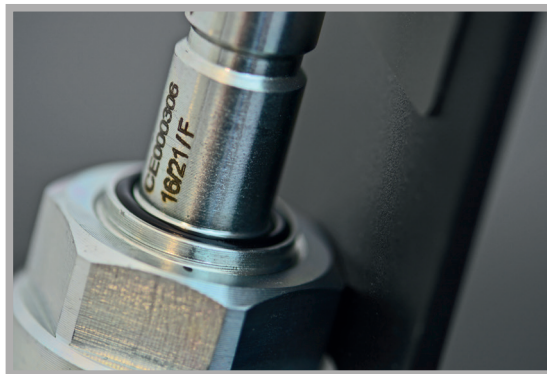

The **new built-in O-ring construction** seals the tube/coil interface, preventing the ingress of weather and providing water resistance up to IP69K standard.



100% of the valves are tested to ensure that internal leakage levels are kept to a minimal amount, **less than 5 drops per minute even for the larger sizes of valve.**

This is up to 75% lower than market standards and ensures greater reliability and better performance.

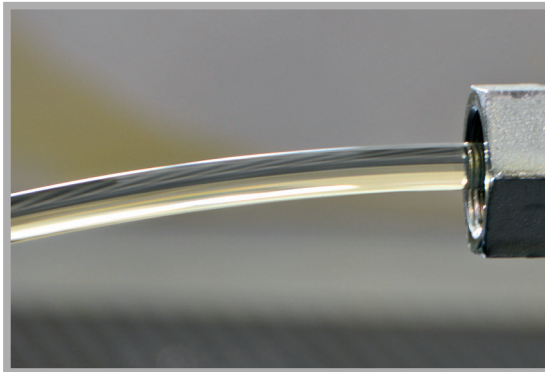

Thanks to state-of-the-art production systems, which prioritise contamination control, the valves achieve **maximum contamination levels of 18/16/13 (per ISO 4406)**. This results in an extended service life for the hydraulic fluids, providing reduced fluid disposal costs as well as improved component wear rates.

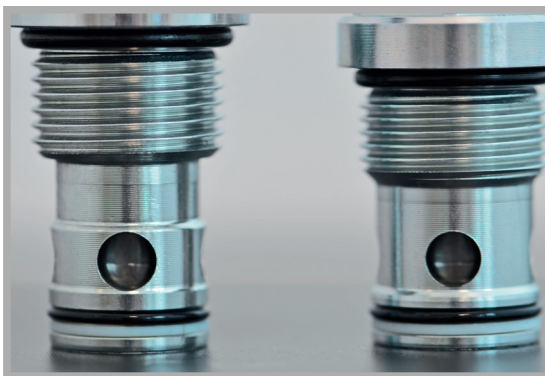

Cartridges that fit in **SAE-12-2N cavities feature a special design of the external body** that makes them more energy efficient.

THE SPOOL SOLENOID VALVES

Reliable performance across the range

The Atlantic **spool** cartridge range encompasses **2-2, 3-2, 4-2** and **4-3 configurations**.

The design of the valves is optimised to achieve the maximum performance with **minimum leakage rates** and the **lowest pressure drop** values.

A wide range of spool configurations is available as well as several manual override options.



THE PROPORTIONAL SOLENOID VALVES

Atlantic high-end range for the most difficult tasks

This range of **proportional** valves was developed in order to provide the **highest standard of stability and linear response** over a wide scope of operation.

The range includes:

- **pressure-reducing valves**
- **pressure-relief valves**
- **flow control valves.**

Several options are available and the valves fit into a wide range of industry standard cavities.







Atlantic Fluid Tech solenoid valves are designed and manufactured with high-resistance materials to **last 30% longer** than market averages.

The 350 bar (5000 psi) rated valves have a fatigue life of 2 million cycles when operated at their maximum nominal pressure. Reducing peak working pressure to 280 bar (4000 psi) extends this life to 10 million cycles. Similarly the 500 bar (7200 psi) rated valves have a fatigue life of 1 million cycles at the nominal pressure increasing to 2 million cycles when operated with maximum pressures of 420 bar (6000 psi) and to 10 million cycles at 320 bar (4500 psi).

Burst pressure is 950 bar (13700 psi) for the 350 bar (5000 psi) rated valves and 1300 bar (18800 psi) for the 500 bar (7200 psi) rated cartridges.



High safety standards are guaranteed in Atlantic valves, for instance the **MTTFd** (mean time to dangerous failure) figure is **150 years**, calculated in accordance with EN ISO 13849.



Two coating options are available: zinc plating that gives 360 hours resistance to salt spray and a **Zinc Nickel coating which ensures 1000 hours resistance to salt spray**.

This latter treatment is therefore highly recommended for extremely demanding applications.

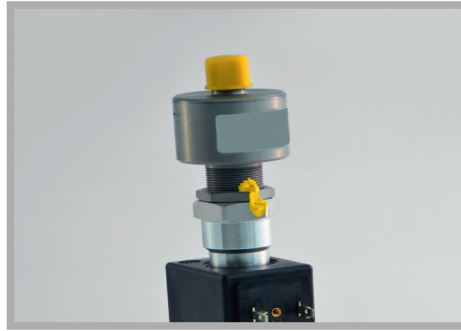
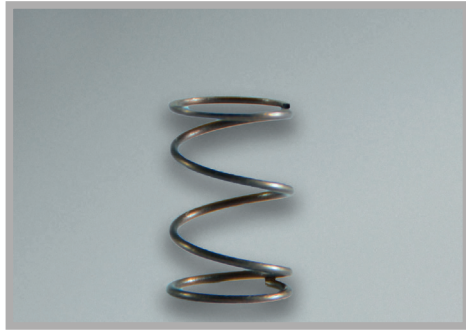

All Atlantic Fluid Tech valves have a **fast response time**: less than 50 ms when opening and less than 100 ms when closing. A **position indicator** can be mounted on the top of all pilot operated valves.

In order to decrease the closing response time when operating with a low flow, all Atlantic valves can be fitted with an **extra spring** (it is fitted as standard to indicator versions).

Valve **coils** can be replaced by the customer and are available as spare parts, including **on valves fitted with indicators**.

Atlantic solenoid coils are available in a variety of **AC and DC voltages** and **electrical connectors** like DIN, AMP and Deutsch complying with IP65, IP67 and IP69k standards.



NBR (Buna) or **Viton seals** can be specified. The Viton seals are standard for valves fitted with indicators.

The NBR seals are suitable for operation from -40°C to 100°C (-104°F to 212°F) and with an ambient or storage temperature from -40°C to 70°C (-104°F to 160°F).

Viton seals are best with fluids operating at a range from -25°C to 204°C (-15°F to 400°F) and with an ambient or storage temperature range from -30°C to 90°C (-22°F to 195°F).

The **manual override** is intended for emergency use and is available on all models of solenoid cartridges. Atlantic Fluid Tech offers various manual override options for both normally closed and normally open valves.

The manual override can be hand-operated, push and twist style, push and pull style, knob, cable and push style.

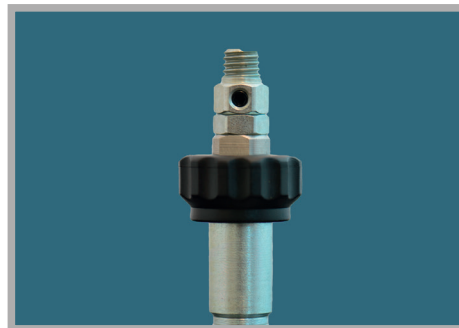
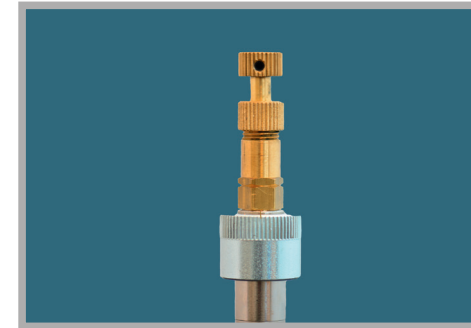

2-WAY ON-OFF SOLENOID VALVES

General Catalogue Section 15

Hydraulic scheme	Valve description	Rated flow l/min [gpm]	Max. pressure bar [psi]	Cavity type
	CEBD-001-NCFN-15-S08 CEBD-001-NCFN-15-445	1,5 [0,4] 1 [0,3]	350/500 [5000/7200] 350 [5000]	SAE-08-2N VP000445
	CEBD-001-NCFN-16-S08 CEBD-001-NCFN-16-445	1,5 [0,4] 1 [0,3]	350/500 [5000/7200] 350 [5000]	SAE-08-2N VP000445
	CEBD-001-NAFN-13-S08 CEBD-001-NAFN-13-445	1,5 [0,4] 1 [0,3]	350/500 [5000/7200] 350 [5000]	SAE-08-2N VP000445
	CEBD-001-NAFN-14-S08 CEBD-001-NAFN-14-445	1,5 [0,4] 1 [0,3]	350/500 [5000/7200] 350 [5000]	SAE-08-2N VP000445
	CEBD-015-NCFN-21-S08	15 [4]	210 [3000]	SAE-08-2N
	CEBN-060-NCFN-01-S08 CEBN-060-NCFN-01-S08 CEBN-080-NCFN-01-S10 CEBN-110-NCFN-01-057 CEBN-190-NCFN-01-S12 CEBN-210-NCFN-01-013 CEBN-310-NCFN-01-S16	60 [16] 60 [16] 80 [21] 110 [29] 190 [50] 210 [55] 310 [82]	350/500 [5000/7200]	SAE-08-2N SAE-08-2N SAE-10-2N VP000057 SAE-12-2N VP000013 SAE-16-2N
	CEBE-030-NCFN-05-S08 CEBN-060-NCFN-05-S08 CEBN-080-NCFN-05-S10 CEBN-110-NCFN-05-057 CEBN-190-NCFN-05-S12 CEBN-210-NCFN-05-013 CEBN-310-NCFN-05-S16	30 [8] 60 [16] 80 [21] 110 [29] 190 [50] 210 [55] 310 [82]	350/500 [5000/7200]	SAE-08-2N SAE-08-2N SAE-10-2N VP000057 SAE-12-2N VP000013 SAE-16-2N
	CEBN-060-NCFN-03-S08 CEBN-080-NCFN-03-S10 CEBN-110-NCFN-03-057 CEBN-210-NCFN-03-013 CEBN-310-NCFN-03-S16	60 [16] 80 [21] 110 [29] 210 [55] 310 [82]	350/500 [5000/7200]	SAE-08-2N SAE-10-2N VP000057 VP000013 SAE-16-2N
	CEBN-060-NAFN-02-S08 CEBN-080-NAFN-02-S10 CEBN-110-NAFN-02-057 CEBN-190-NAFN-02-S12 CEBN-210-NAFN-02-013 CEBN-310-NAFN-02-S16	60 [16] 80 [21] 110 [29] 190 [50] 210 [55] 310 [82]	350/500 [5000/7200]	SAE-08-2N SAE-10-2N VP000057 SAE-12-2N VP000013 SAE-16-2N
	CEBE-030-NAFN-06-S08 CEBN-060-NAFN-06-S08 CEBN-080-NAFN-06-S10 CEBN-110-NAFN-06-057 CEBN-190-NAFN-06-S12 CEBN-210-NAFN-06-013 CEBN-310-NAFN-06-S16	30 [8] 60 [16] 80 [21] 110 [29] 190 [50] 210 [55] 310 [82]	350/500 [5000/7200]	SAE-08-2N SAE-08-2N SAE-10-2N VP000057 SAE-12-2N VP000013 SAE-16-2N

Hydraulic scheme	Valve description	Rated flow l/min [gpm]	Max. pressure bar [psi]	Cavity type
	CEBN-060-NAFN-04-S08 CEBN-080-NAFN-04-S10 CEBN-110-NAFN-04-057 CEBN-210-NAFN-04-013 CEBN-310-NAFN-04-S16	60 [16] 80 [21] 110 [29] 210 [55] 310 [82]	350/500 [5000/7200]	SAE-08-2N SAE-10-2N VP000057 VP000013 SAE-16-2N
	CEBN-060-NCFN-31-S08 CEBN-080-NCFN-31-S10 CEBN-110-NCFN-31-057 CEBN-190-NCFN-31-S12 CEBN-210-NCFN-31-013 CEBN-310-NCFN-31-S16	60 [16] 80 [21] 110 [29] 190 [50] 210 [55] 310 [82]	350/500 [5000/7200]	SAE-08-2N SAE-10-2N VP000057 SAE-12-2N VP000013 SAE-16-2N
	CEBN-060-NAFN-32-S08 CEBN-080-NAFN-32-S10 CEBN-110-NAFN-32-057 CEBN-190-NAFN-32-S12 CEBN-210-NAFN-32-013 CEBN-310-NAFN-32-S16	60 [16] 80 [21] 110 [29] 190 [50] 210 [55] 310 [82]	350/500 [5000/7200]	SAE-08-2N SAE-10-2N VP000057 SAE-12-2N VP000013 SAE-16-2N
	CEBN-060-NCFN-11-S08 CEBN-080-NCFN-11-S10 CEBN-110-NCFN-11-057 CEBN-190-NCFN-11-S12 CEBN-210-NCFN-11-013 CEBN-310-NCFN-11-S16	60 [16] 80 [21] 110 [29] 190 [50] 210 [55] 310 [82]	350/500 [5000/7200]	SAE-08-2N SAE-10-2N VP000057 SAE-12-2N VP000013 SAE-16-2N
	CEBN-060-NAFN-12-S08 CEBN-080-NAFN-12-S10 CEBN-110-NAFN-12-057 CEBN-190-NAFN-12-S12 CEBN-210-NAFN-12-013 CEBN-310-NAFN-12-S16	60 [16] 80 [21] 110 [29] 190 [50] 210 [55] 310 [82]	350/500 [5000/7200]	SAE-08-2N SAE-10-2N VP000057 SAE-12-2N VP000013 SAE-16-2N
	CEBN-060-XCDR-05-S08 CEBN-080-XCDR-05-S10 CEBN-110-XCDR-05-057 CEBN-190-XCDR-05-S12 CEBN-210-XCDR-05-013 CEBN-310-XCDR-05-S16	60 [16] 80 [21] 110 [29] 190 [50] 210 [55] 310 [82]	350 [5000]	SAE-08-2N SAE-10-2N VP000057 SAE-12-2N VP000013 SAE-16-2N
	CEBN-060-XADR-06-S08 CEBN-080-XADR-06-S10 CEBN-110-XADR-06-057 CEBN-190-XADR-06-S12 CEBN-210-XADR-06-013 CEBN-310-XADR-06-S16	60 [16] 80 [21] 110 [29] 190 [50] 210 [55] 310 [82]	350 [5000]	SAE-08-2N SAE-10-2N VP000057 SAE-12-2N VP000013 SAE-16-2N



Hydraulic scheme	Valve description	Rated flow l/min [gpm]	Max. pressure bar [psi]	Cavity type
	CEBN-060-XCDR-31-S08 CEBN-080-XCDR-31-S10 CEBN-110-XCDR-31-S07 CEBN-190-XCDR-31-S12 CEBN-210-XCDR-31-S13 CEBN-310-XCDR-31-S16	60 [16] 80 [21] 110 [29] 190 [50] 210 [55] 310 [82]	350 [5000]	SAE-08-2N SAE-10-2N VP000057 SAE-12-2N VP000013 SAE-16-2N
	CEBN-060-XCDR-32-S08 CEBN-080-XCDR-32-S10 CEBN-110-XCDR-32-S07 CEBN-190-XCDR-32-S12 CEBN-210-XCDR-32-S13 CEBN-310-XCDR-32-S16	60 [16] 80 [21] 110 [29] 190 [50] 210 [55] 310 [82]	350 [5000]	SAE-08-2N SAE-10-2N VP000057 SAE-12-2N VP000013 SAE-16-2N
	CEBD-040-NAMV-97-338 CEBD-040-NACV-97-338	40 [11]	350 [5000]	VP000338
	CEBN-015-NCGN-01-F45 CEBN-025-NCGN-01-F45 CEBN-060-NCGN-01-F45	15 [4] 25 [7] 60 [16]	600 [8700]	Flanged
	CEBN-060-NCAN-05-S08 CEBN-210-NCAN-05-S13	60 [16] 210 [55]	350 [5000]	SAE-08-2N VP000013

Hydraulic scheme	Valve description	Rated flow l/min [gpm]	Max. pressure bar [psi]	Cavity type
	CEBS-010-NCFN-22-S08	10 [3]	210 [3000]	SAE-08-2N
	CEBS-010-NAFN-23-S08	10 [3]	210 [3000]	SAE-08-2N
	CECS-005-SEFN-61-S08	5 [1,3]	50 [700]	SAE-08-3N
	CECS-005-SEFN-62-S08	5 [1,3]	50 [700]	SAE-08-3N
	CECS-005-SEFN-63-S08	5 [1,3]	50 [700]	SAE-08-3N
	CECS-005-SEFN-64-S08	5 [1,3]	50 [700]	SAE-08-3N
	CECS-010-SEFN-61-S08	10 [3]	350 [5000] Port 1:210 [3000]	SAE-08-3N
	CECS-010-SEFN-62-S08	10 [3]	350 [5000] Port 1:210 [3000]	SAE-08-3N
	CECS-010-SEFN-63-S08	10 [3]	350 [5000] Port 1:210 [3000]	SAE-08-3N
	CECS-010-SEFN-64-S08	10 [3]	350 [5000] Port 1:210 [3000]	SAE-08-3N
	CECS-030-SEFN-66-S10	30 [8]	350 [5000]	SAE-10-3N
	CECS-030-SEFN-61-S10	30 [8]	350 [5000]	SAE-10-3N
	CECS-030-SEFN-62-S10	30 [8]	350 [5000]	SAE-10-3N
	CECS-030-SEFN-63-S10	30 [8]	350 [5000]	SAE-10-3N
	CECS-030-SEFN-64-S10	30 [8]	350 [5000]	SAE-10-3N



1800-OILSOL
1800-645765

<https://oilsolutions.com.au/>

sales@oilsolutions.com.au

SPOOL SOLENOID VALVES

Hydraulic scheme	Valve description	Rated flow l/min [gpm]	Max. pressure bar [psi]	Cavity type
	CEBT-350-NCFN-98-S16 CEBT-600-NCFN-98-S20	350 [92] 600 [158]	350 [5000]	SAE-16-2N SAE-20-2N
	CEBT-350-NAFN-99-S16 CEBT-600-NAFN-99-S20	350 [92] 600 [158]	350 [5000]	SAE-16-2N SAE-20-2N

PROPORTIONAL VALVES

General Catalogue Section 16

Hydraulic scheme	Valve description	Rated flow l/min [gpm]	Max. pressure bar [psi]	Cavity type
	CEDS-010-SEFN-40-S08	10 [3]	350 [5000] Port 1:210 [3000]	SAE-08-4N
	CEDS-010-SEFN-49-S08	10 [3]	350 [5000] Port 1:210 [3000]	SAE-08-4N
	CEDS-010-SEFN-41-S08	10 [3]	350 [5000] Port 1:210 [3000]	SAE-08-4N
	CEDS-010-SEFN-43-S08	10 [3]	350 [5000] Port 1:210 [3000]	SAE-08-4N
	CEDS-030-SEFN-40-S10	30 [8]	350 [5000]	SAE-10-4N
	CEDS-030-SEFN-41-S10	30 [8]	350 [5000]	SAE-10-4N
	CEDS-030-SEFN-43-S10	30 [8]	350 [5000]	SAE-10-4N
	CEDS-030-SEFN-111-S10	30 [8]	350 [5000]	SAE-10-4N
	CEES-010-SEFN-51-S08	10 [3]	350 [5000] Port 1:210 [3000]	SAE-08-4N
	CEES-010-SEFN-52-S08	10 [3]	350 [5000] Port 1:210 [3000]	SAE-08-4N
	CEES-010-SEFN-53-S08	10 [3]	350 [5000] Port 1:210 [3000]	SAE-08-4N
	CEES-010-SEFN-54-S08	10 [3]	350 [5000] Port 1:210 [3000]	SAE-08-4N

Hydraulic scheme	Valve description	Rated flow l/min [gpm]	Max. pressure bar [psi]	Cavity type
	CECS-005-PRPN-95-371	5 [1,3]	50 [700]	VP000371
	CECT-080-PRPS-96-S10	80 [21]	250 [3600]	SAE-10-3N
	CEBD-005-PLPS-92-S08	5 [1,3]	350 [5000]	SAE-08-2N
	CEBD-005-PMPS-92-S08	5 [1,3]	350 [5000]	SAE-08-2N
	CEBT-120-PMPS-91-S10	120 [32]	320 [4600]	SAE-10-2N
	CEBT-120-PLPS-91-S10 CEBT-300-PLPS-91-S16 CEBT-500-PLPS-91-S20	120 [32] 300 [79] 500 [132]	350 [5000]	SAE-10-2N SAE-16-2N SAE-20-2N
	CECS-020-FSPS-85-S10 CECS-030-FSPS-85-S10 CECS-040-FSPS-85-S10	20 [5] 30 [8] 40 [11]	210 [3000]	SAE-10-3N
	CECS-050-FRPM-30-S10 CECS-140-FRPV-XX-S16	50 [13] 140 [37]	320 [4600] 320 [4600]	SAE-10-3N SAE-16-3N
	CEBS-020-PEPS-103-S08 CEBS-020-PEPS-103-064	20 [5] 20 [5]	210 [3000] 210 [3000]	SAE-08-2N VP000064
	ELPC-030-SCCB	-	-	-



COILS AND CONNECTORS

General Catalogue Section 21

Description	Heat insulation class	Connector
Coil M7 HS Coil M7 HS RAC Coil M7 AJ Coil M7 DTV Coil M7 DTO	H - 180°C [H - 356°F]	DIN 43650 - ISO 4400 DIN 43650 - ISO 4400 Amp Junior Deutsch - DT04-2P-L Deutsch - DT04-2P-V
Coil M14 HS Coil M14 AJ Coil M14 DTV	H - 180°C [H - 356°F]	DIN 43650 - ISO 4400 Amp Junior Deutsch - DT04-2P-V
Coil M15 HS Coil M15 AJ Coil M15 DTV	H - 180°C [H - 356°F]	DIN 43650 - ISO 4400 Amp Junior Deutsch - DT04-2P-V
Coil M8 HS Coil M8 AJ Coil M8 DTV	H - 180°C [H - 356°F]	DIN 43650 - ISO 4400 Amp Junior Deutsch - DT04-2P-V
Coil M16 HS Coil M16 AJ Coil M16 DTV	H - 180°C [H - 356°F]	DIN 43650 - ISO 4400 Amp Junior Deutsch - DT04-2P-V
DIN Connector	-	DIN 43650 - ISO 4400





1800-OILSOL
1800-645765

<https://oilsolutions.com.au/>

sales@oilsolutions.com.au



..... Atlantic Fluid Tech is committed to protecting the natural environment. Beginning with the design phase and then throughout the life cycle of its products, the company seeks to minimise their environmental impact.

It has a continuous commitment to the following goals:

- to design valves and hydraulic assemblies that are lighter and more compact in order to reduce raw material consumption and so reduce the logistical impact on the world;
- to make valves that help to reduce the fuel consumption of the machines they are fitted to;
- to establish innovative design and production methods that lead to longer valve lifetimes;
- to comply with the latest European Directives and consequently to avoid the use of hazardous substances in the production processes;
- to use recyclable packaging materials;
- to share with customers all information regarding the sustainability policy of the Company and its products

**From the Company's official Declaration of Commitment to Environmental Sustainability within the framework of ISO 14001 Certification
"Life cycle perspective of products"**



**ISO 9001 Quality Management System Certification
ISO 14001 Environmental Management System Certification
ISO 45001 Occupational Health and Safety Management System Certification**

Atlantic Fluid Tech srl. All rights reserved.
Ref. no. AL000008



1800-OILSOL
1800-645765

<https://oilsolutions.com.au/>

sales@oilsolutions.com.au



CONTACT DETAILS

HEADQUARTERS ITALY

Via della Meccanica, 50
41018 S. Cesario sul Panaro
Modena

 atlanticfluidtech.com

 info@atlanticfluidtech.com



UNITED KINGDOM

Atlantic Fluid Tech LTD

1 Industrial Park
Henley Road
Coventry, CV21ST

 uk@atlanticfluidtech.com

THE NETHERLANDS

Atlantic Fluid Tech BV

Ampèrestraat 4
2181 HB Hillegom

 nl@atlanticfluidtech.com

FRANCE

Atlantic Fluid Tech SAS

28, Rue des Pyrénées
Zac de Didenheim (Lot F)
FR-68350 Didenheim

 france@atlanticfluidtech.com

SOUTH KOREA

Atlantic Fluid Tech LLC

97 Block 13 Lot. Namdong
Ind. Complex 644-12 Gojandong
Namdong-Gu, Incheon City

 korea@atlanticfluidtech.com

JAPAN

Atlantic Fluid Tech KK

Izumi Bldg. 6F, 2-29-4 Hakusan
Bunkyo-Ku, Tokyo, 112-0001

 jpcontact@atlanticfluidtech.co.jp



1800-OILSOL <https://oilsolutions.com.au/>
1800-645765

sales@oilsolutions.com.au