



ATLANTIC
Fluid Tech



OIL SOLUTIONS

PO Box 38
Strathfieldsaye, VIC, 3551
1800 OIL SOL
1800 645 765

sales@oilsolutions.com.au

www.oilsolutions.com.au

"For All Your Hydraulic Needs"

**SECTION
18**

Modular
Valves for
Cetop

SECTION 18

MODULAR VALVES FOR CETOP



Hydraulic scheme	Valve description	Valve type	Rated flow (l/min)	Max. pressure (bar)	Installation	Main port size or cavity type	Page
	BNND-040-LE	Left version	40	210	Flanged	Cetop 3	18.01.010
	BNND-040-LE	Right version	40	210	Flanged	Cetop 3	18.01.010
	BNFN-040-NT	Pilot operated, cetop 3	40	210	Flanged	Cetop 3	18.02.020
	KPLN-030-DPNA	Direct acting, cetop 3	30	210	Flanged	Cetop 3	18.03.030
	KPLN-030-DPNA	Direct acting, poppet type, subplate cetop 3	30	350	Flanged	Cetop 3	18.04.040
	KPLN-080-DPNA	Direct acting, poppet type, subplate cetop 5	80	350	Flanged	Cetop 5	18.04.050
	KPLT-030-DPNA	Direct acting, compensated	30	210	Flanged	Cetop 3	18.05.060
	MBSN-060-ZTNR	Single acting, cetop 3	60	250	Flanged	Cetop 3	18.06.070
	MBSN-060-ATNR	Single acting, cetop 3	60	350	Flanged	Cetop 3	18.06.080
	MBST-100-ZTNP	Single acting, cetop 5	100	250	Flanged	Cetop 5	18.07.090
	MBDN-030-LTNR	Double acting, cetop 3	30	210	Flanged	Cetop 3	18.08.100
	MBDN-060-ZTNR	Double acting, cetop 3	60	210	Flanged	Cetop 3	18.08.110
	MBDN-060-ATNR	Double acting, cetop 3	60	350	Flanged	Cetop 3	18.08.120
	MBDN-100-ZTNR	Double acting, cetop 5	100	350	Flanged	Cetop 5	18.08.130
	MBDP-060-ZTNR	Double acting, cetop 3	60	210	Flanged	Cetop 3	18.10.140
	MBDT-100-ATNR	Double acting, cetop 5	100	350	Flanged	Cetop 5	18.09.150

MODULAR VALVE FOR CETOP

BNND-040-LE

CETOP 3

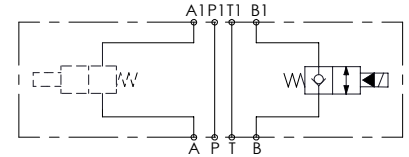
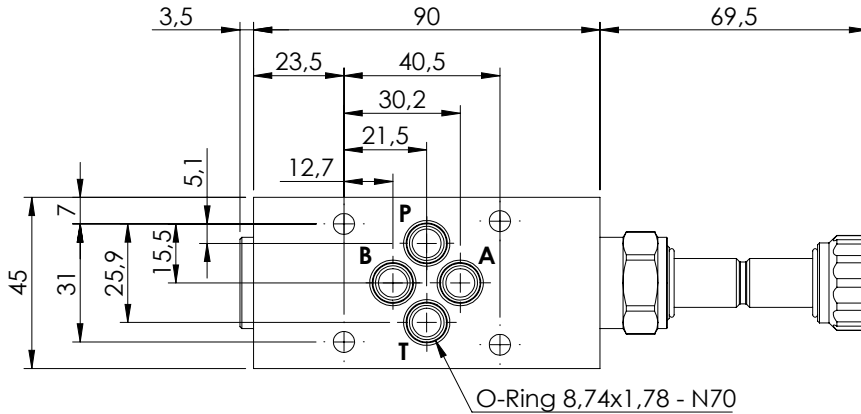
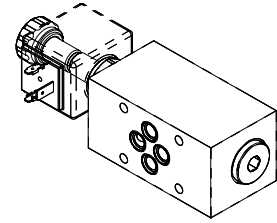

Coil type M7 not included and to be ordered separately

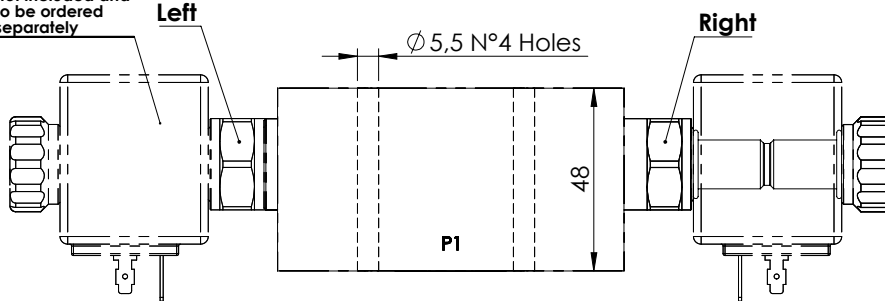

SPECIFICATIONS

Max. operating pressure:	210 bar
Rated flow:	40 l/min
Cavity:	Aluminium
Weight:	0,61 kg
Coil type:	M7

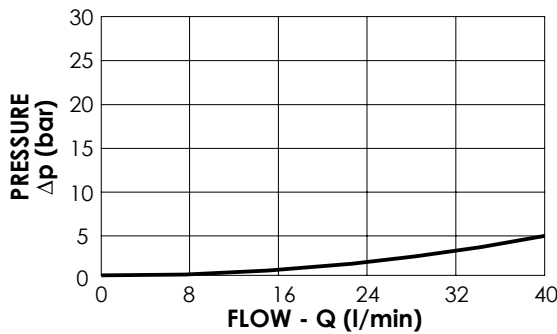

NOTES

ORDERING CODES

Quick code	Description	Main ports size	Version
BD000034	BNND-040-LE-N06-N210-R	A,B,P,T: CETOP 3	Right
BD000119	BNND-040-LE-N06-N210-L	A,B,P,T: CETOP 3	Left

MODULAR VALVE FOR CETOP

BNFN-040-NT

CETOP 3

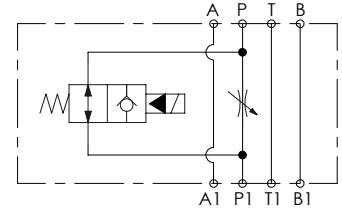
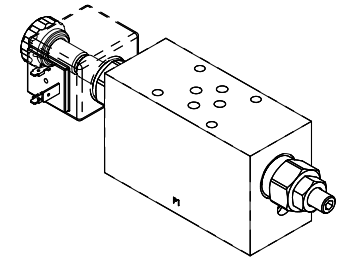
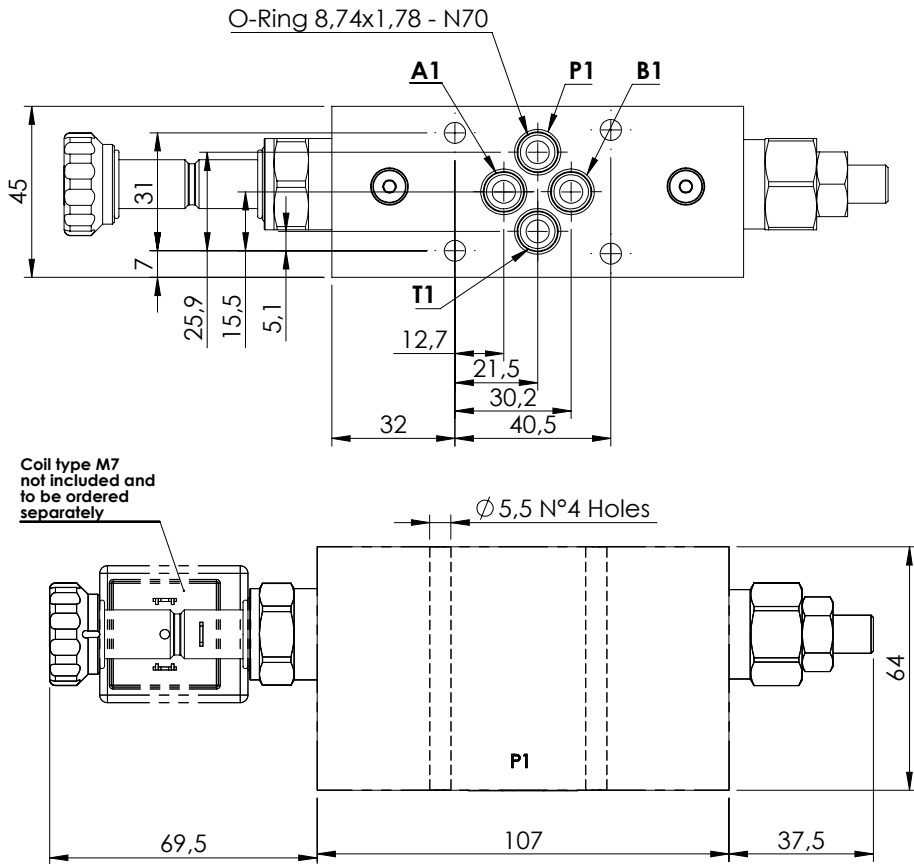

SPECIFICATIONS

Max. operating pressure:	210 bar
Rated flow:	40 l/min
Manifold:	Aluminium
Weight:	1 kg
Coil type:	M7

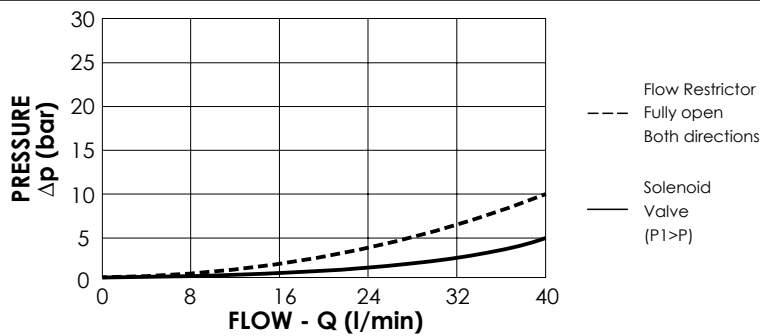

NOTES

ORDERING CODES

Quick code	Description	Main ports size
BF000004	BNFN-040-NT-N06-N210	A,B,P,T: CETOP 3

MODULAR VALVE FOR CETOP

KPLN-030-DPNA

CETOP 3

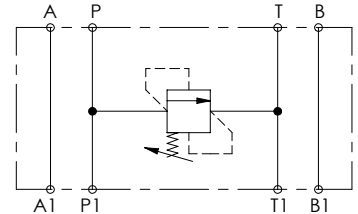
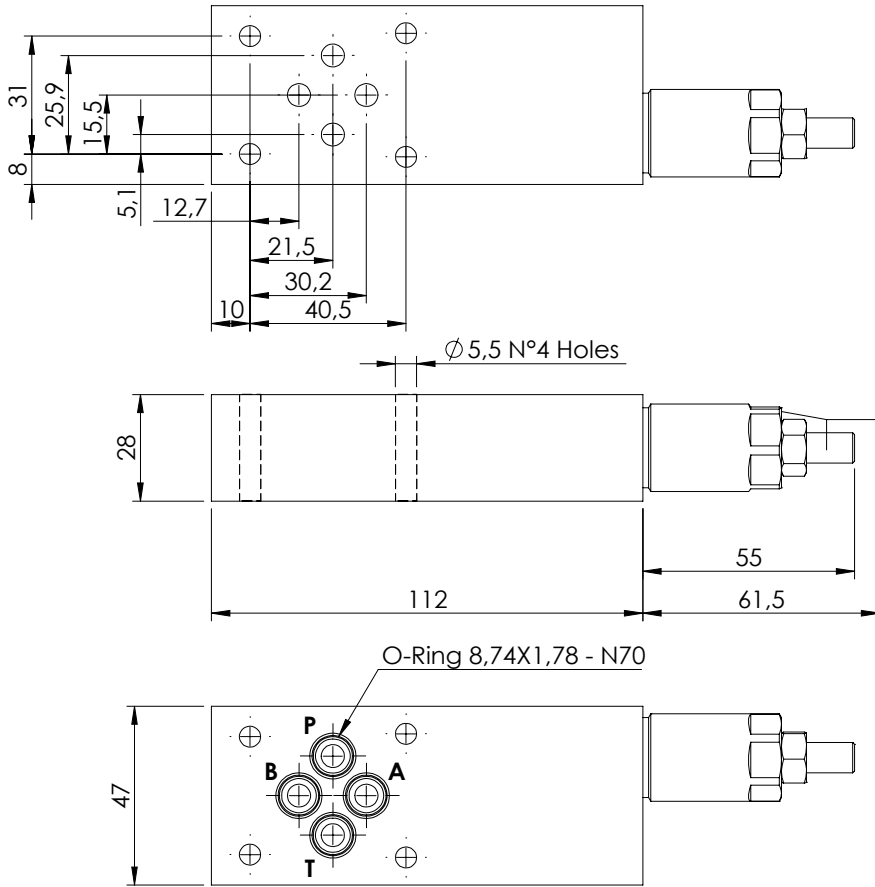
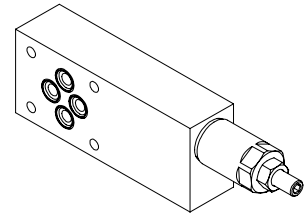

SPECIFICATIONS

Max. operating pressure:	210 bar
Rated flow:	30 l/min
Manifold:	Aluminium
Weight:	0,52 kg

SEALING CAP

Ordering code:
AT000020

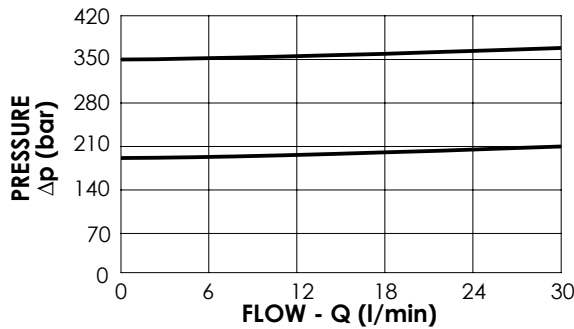
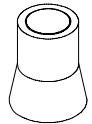

NOTES

ORDERING CODES

Quick code	Description	Main ports size	Standard setting (bar, Q=5 l/min)	Adjustm. range (bar)	Pressure increase (bar/turn)
KP000170	KPLN-030-DPNA-HN-N06-N350	A,B,P,T: CETOP 3	350	100-350	91
KP000112	KPLN-030-DPNA-HN-N06-N200	A,B,P,T: CETOP 3	200	50-210	42

MODULAR VALVE FOR CETOP

KPLN-030-DPNA

**CETOP 3
SUBPLATE**

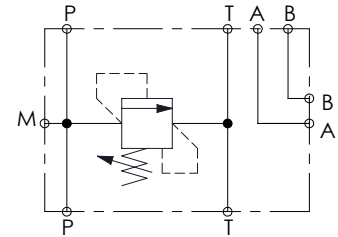
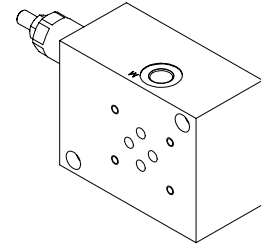
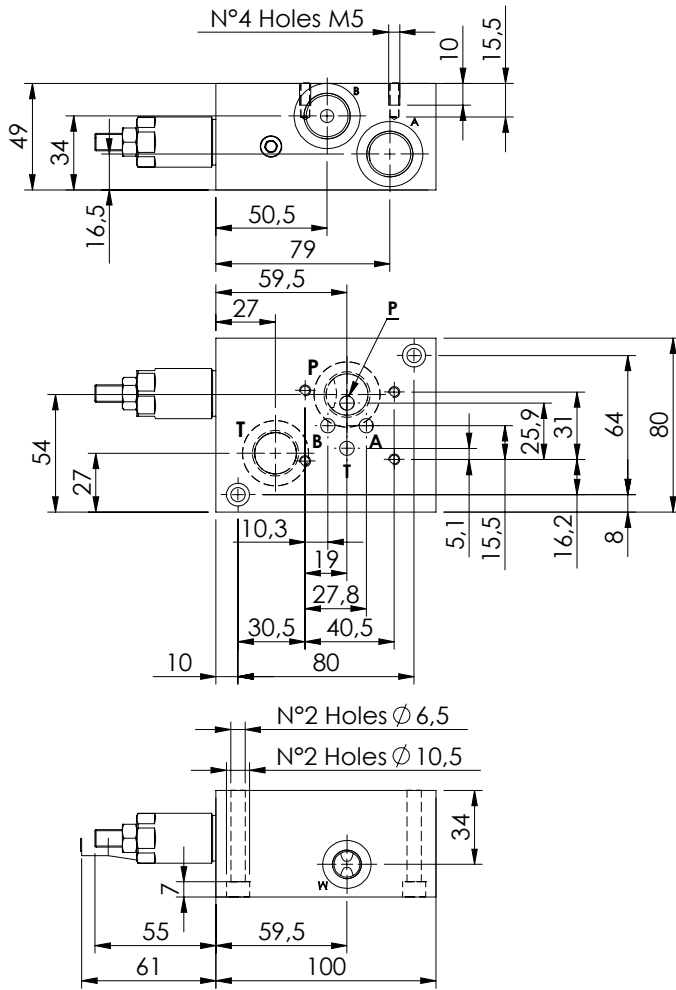

SPECIFICATIONS

Max. operating pressure:	350 bar
Rated flow:	30 l/min
Manifold:	Aluminium
Weight:	1,04 kg

SEALING CAP

Ordering code:
AT000020

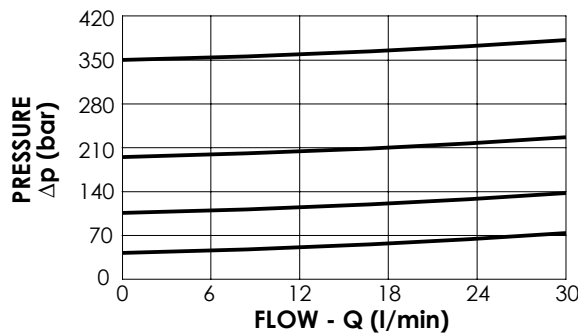
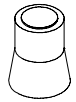

NOTES

ORDERING CODES

Quick code	Description	Main ports size	Standard setting (bar, Q=5 l/min)	Adjustm. range (bar)	Pressure increase (bar/turn)
KP000071	KPLN-030-DPNA-HN-N06-N350	A,B,P,T: CETOP 3 A,B,P,T: G 1/2" ; M: G1/4"	350	100-350	91
KP000072	KPLN-030-DPNA-HN-N06-N200	A,B,P,T: CETOP 3 A,B,P,T: G 1/2" ; M: G1/4"	200	50-210	42
KP000073	KPLN-030-DPNA-HN-N06-N100	A,B,P,T: CETOP 3 A,B,P,T: G 1/2" ; M: G1/4"	100	30-100	20
KP000074	KPLN-030-DPNA-HN-N06-N050	A,B,P,T: CETOP 3 A,B,P,T: G 1/2" ; M: G1/4"	50	5-50	10

MODULAR VALVE FOR CETOP

KPLN-080-DPNA

**CETOP 5
SUBPLATE**

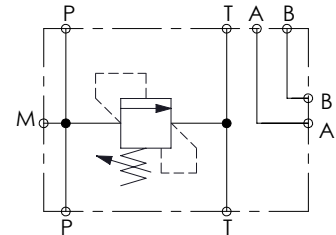
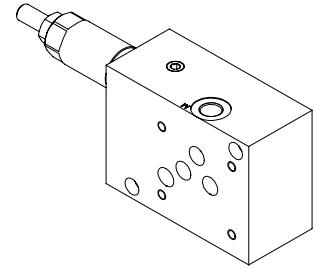
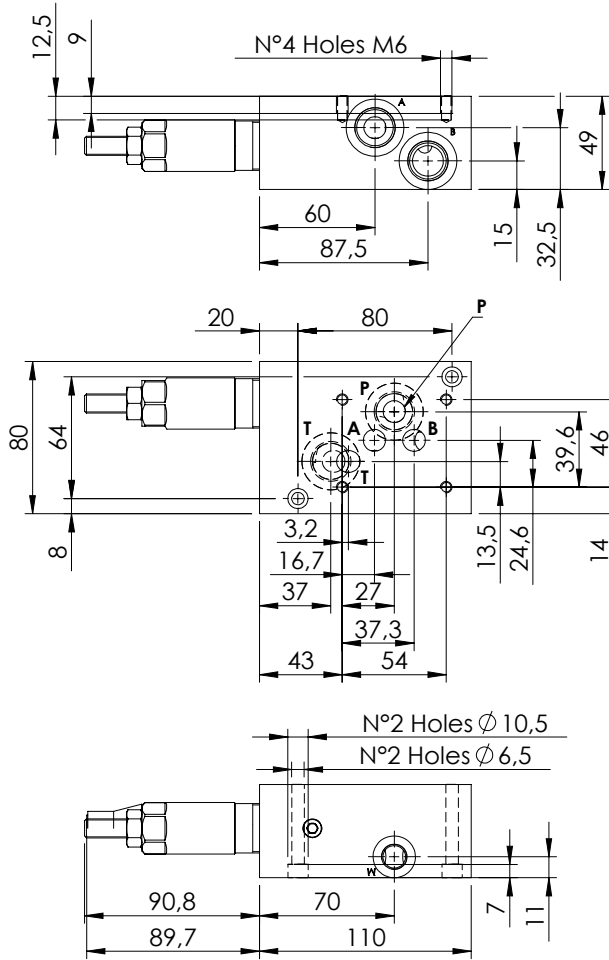

SPECIFICATIONS

Max. operating pressure:	350 bar
Rated flow:	80 l/min
Manifold:	Aluminium
Weight:	1,26 kg

SEALING CAP

Ordering code:
AT000021

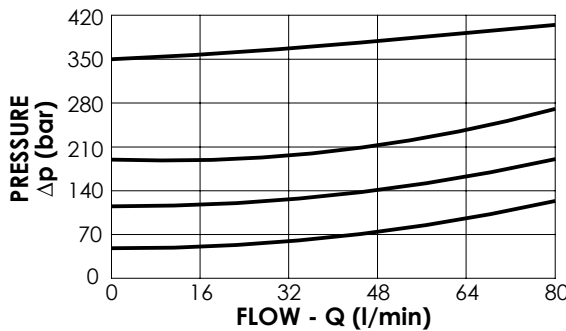
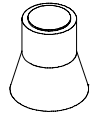

NOTES

ORDERING CODES

Quick code	Description	Main ports size	Standard setting (bar, Q=5 l/min)	Adjustm. range (bar)	Pressure increase (bar/turn)
KP000075	KPLN-080-DPNA-HN-N10-N350	A,B,P,T: CETOP 5 A,B,P,T: G 1/2" ;M: G1/4"	350	100-350	42
KP000076	KPLN-080-DPNA-HN-N10-N200	A,B,P,T: CETOP 5 A,B,P,T: G 1/2" ;M: G1/4"	200	60-210	24
KP000077	KPLN-080-DPNA-HN-N10-N100	A,B,P,T: CETOP 5 A,B,P,T: G 1/2" ;M: G1/4"	100	25-100	13
KP000102	KPLN-080-DPNA-HN-N10-N050	A,B,P,T: CETOP 5 A,B,P,T: G 1/2" ;M: G1/4"	50	5-50	9

MODULAR VALVE FOR CETOP

KPLT-030-DPNA

CETOP 3

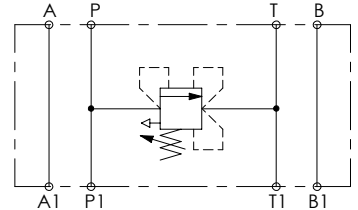
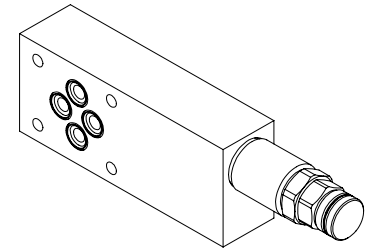
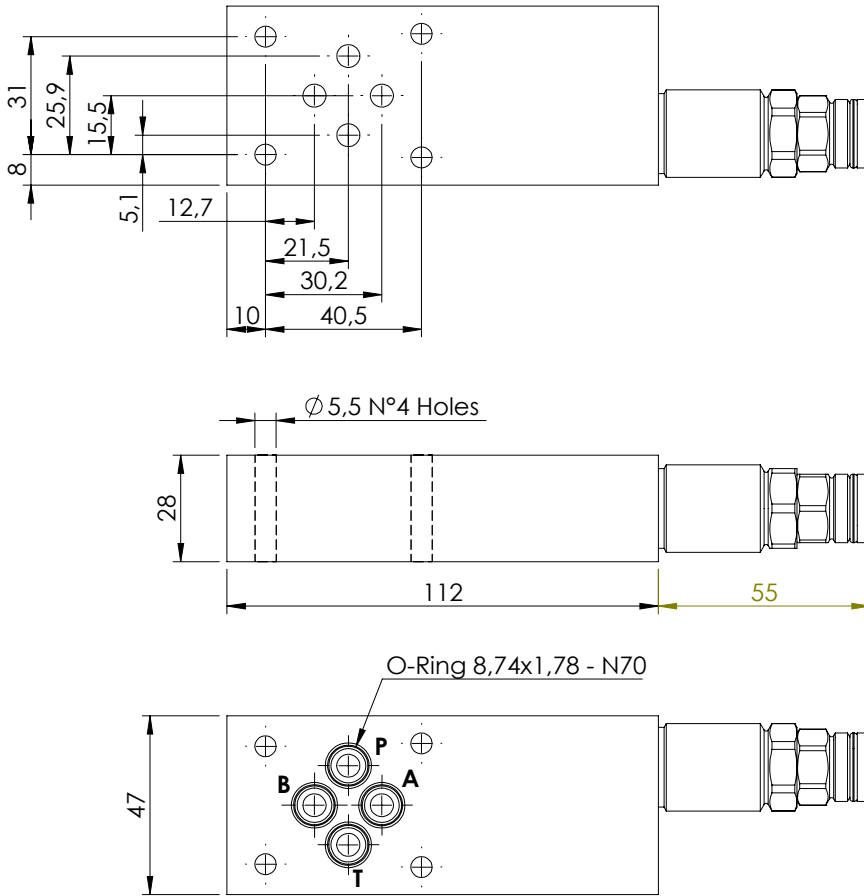

SPECIFICATIONS

Max. operating pressure:	210 bar
Rated flow:	30 l/min
Manifold:	Aluminium
Weight:	0,54 kg

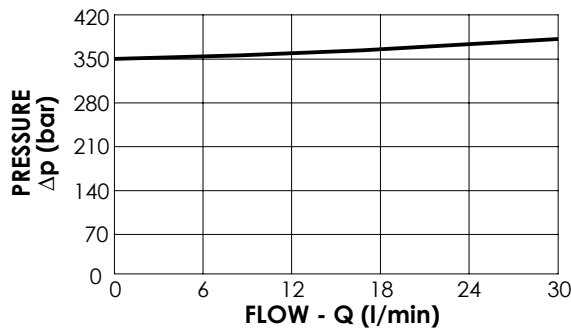

NOTES

ORDERING CODES

Quick code	Description	Main ports size	Standard setting (bar, Q=5 l/min)	Adjustm. range (bar)	Pressure increase (bar/turn)
KP000171	KPLT-030-DPNA-HN-N06-N350	A,B,P,T: CETOP 3	350	100-350	91

MODULAR VALVE FOR CETOP

MBSN-060-ZTNP

**SINGLE ACTING
CETOP 3**



O-Ring 8,74x1,78 - N90

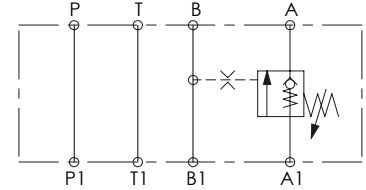
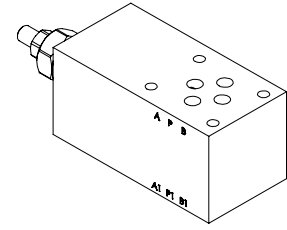
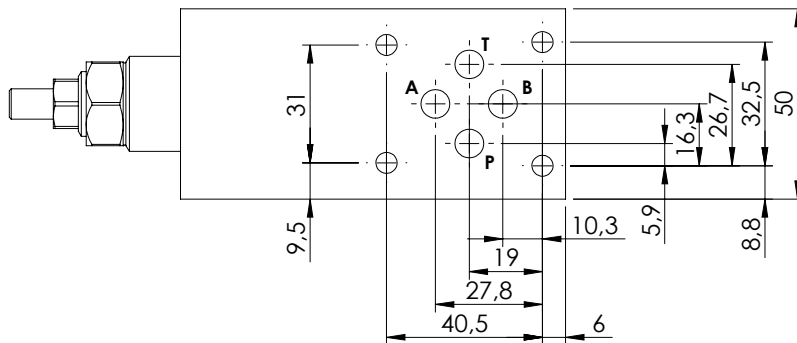
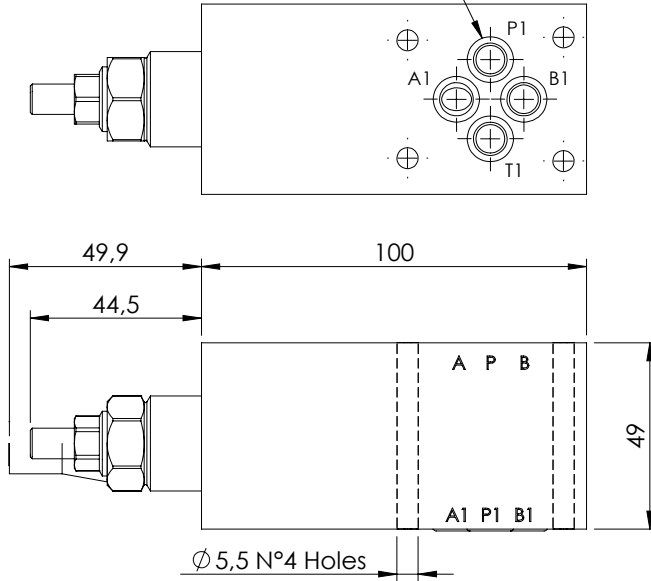

SPECIFICATIONS

Max. operating pressure:	250 bar
Rated flow:	60 l/min
Manifold:	Aluminium
Weight:	724,9 g

SEALING CAP

Ordering code:
AT000020

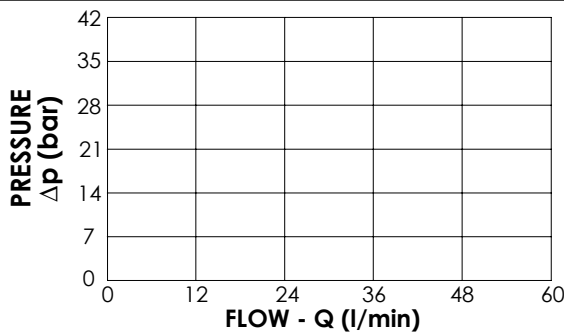
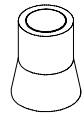

NOTES

Setting: at least 1.3 times the load induced pressure

ORDERING CODES

Quick code	Description	Pilot ratio	Main ports size	Standard setting (bar, Q=5 l/min)	Adjust. range (bar)	Pressure increase (bar/turn)
MB000923	MBSN-060-ZTNP-01-N06-N250	1:0	A,B,P,T: CETOP 3	25	3-30	5

CETOP AND MODULAR VALVE

MBSN-060-ARNR

**SINGLE ACTING
CETOP 3**



O-Ring 8,74x1,78 - N70



Ø 5,3 N°4 Holes

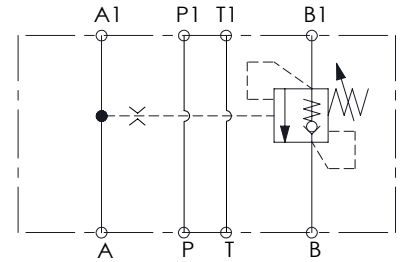
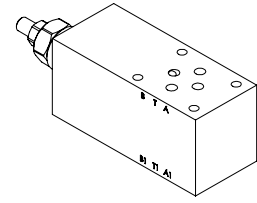
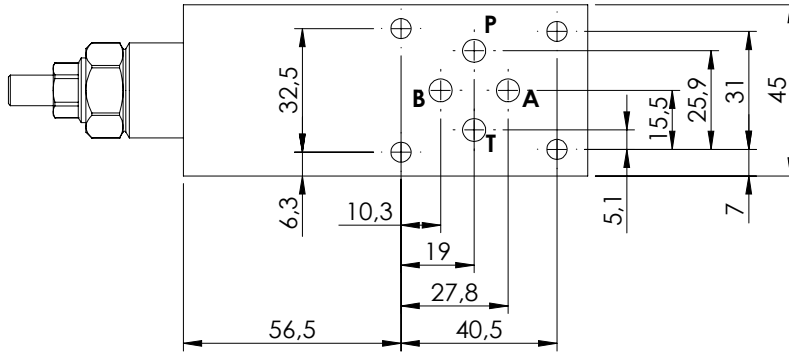
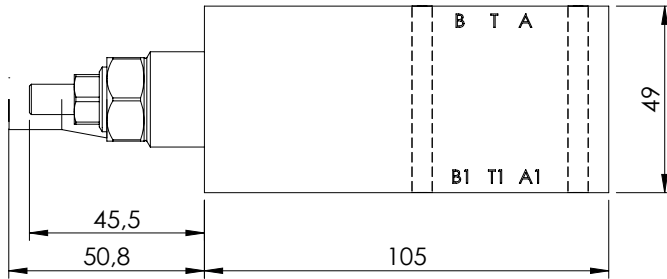

SPECIFICATIONS

Max. operating pressure:	350 bar
Rated flow:	60 l/min
Manifold:	Steel
Weight:	1,78 kg

SEALING CAP

Ordering code:
AT000020

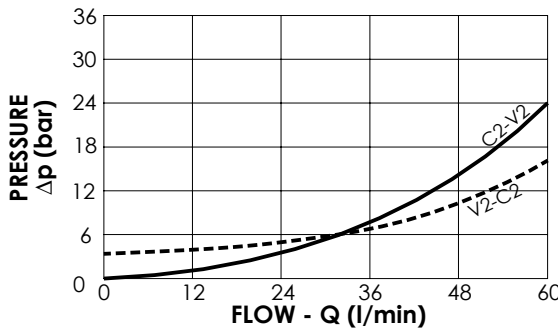
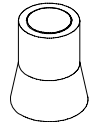

NOTES

Setting: at least 1.3 times the load induced pressure

ORDERING CODES

Quick code	Description	Pilot ratio	Main ports size	Standard setting (bar, Q=5 l/min)	Adjust. range (bar)	Pressure increase (bar/turn)
MB000886	MBSN-060-ATNR-04-N06-N350	4,2:1	A,B,P,T: CETOP 3	350	100-350	139

MODULAR VALVE FOR CETOP

MBST-100-ZTNP

**SINGLE ACTING
CETOP 5**



O-Ring 12,42x1,78 - N70

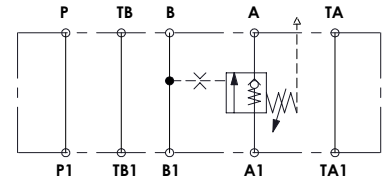
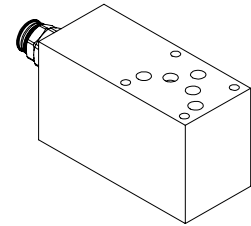
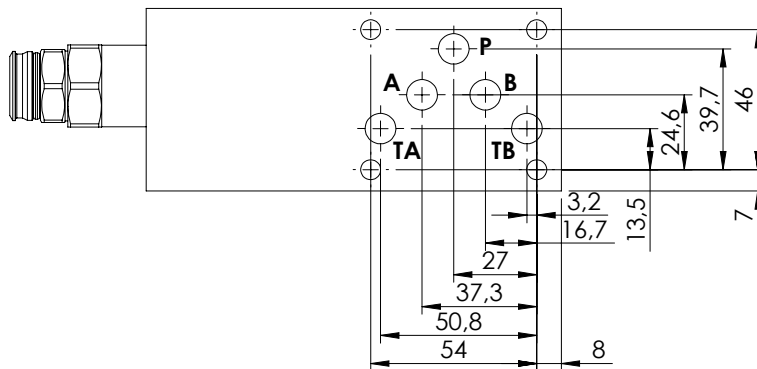
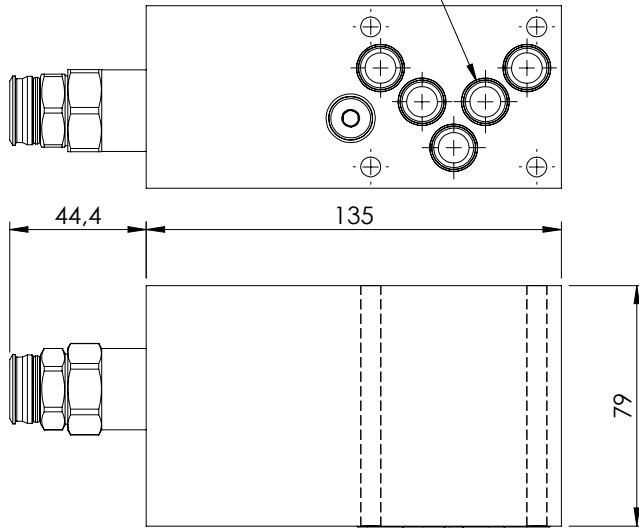

SPECIFICATIONS

Max. operating pressure:	250 bar
Rated flow:	100 l/min
Manifold:	Aluminium
Weight:	1734,8 g

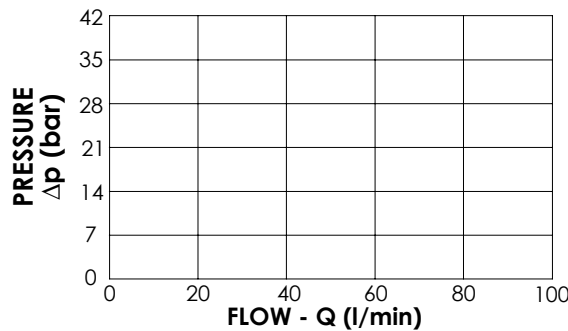

NOTES

Setting: at least 1.3 times the load induced pressure

ORDERING CODES

Quick code	Description	Pilot ratio	Main ports size	Standard setting (bar, Q=5 l/min)	Adjust. range (bar)	Pressure increase (bar/turn)
MB000924	MBST-100-ZTNP-01-T10-N250	1:0	A,B,P,T: CETOP 5	10	3-25	8

MODULAR VALVE FOR CETOP

MBDN-030-LTNR

**DOUBLE ACTING
CETOP 3**

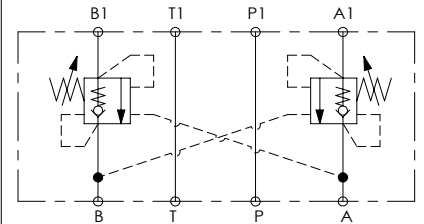
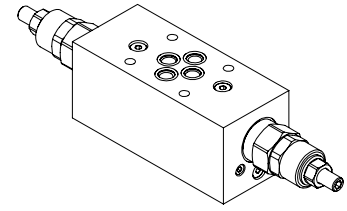
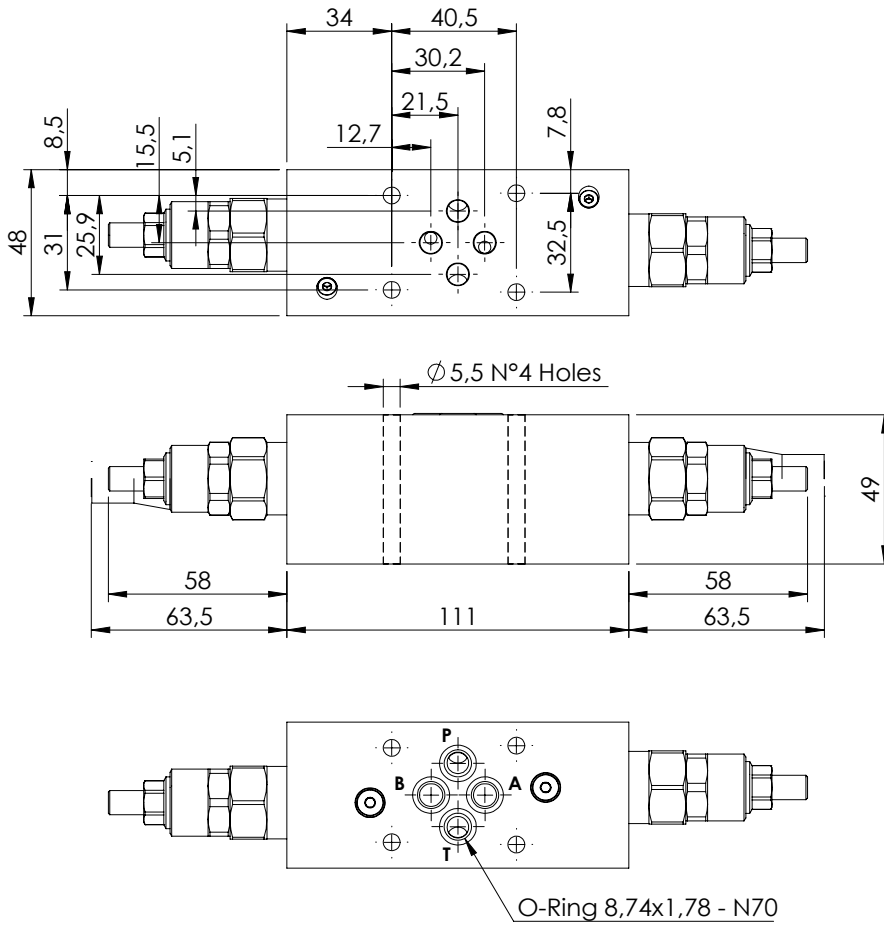

SPECIFICATIONS

Max. operating pressure:	210 bar
Rated flow:	30 l/min
Manifold:	Aluminium
Weight:	1 kg

SEALING CAP

Ordering code:
AT000020

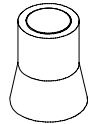

NOTES

Setting: at least 1.3 times the load induced pressure

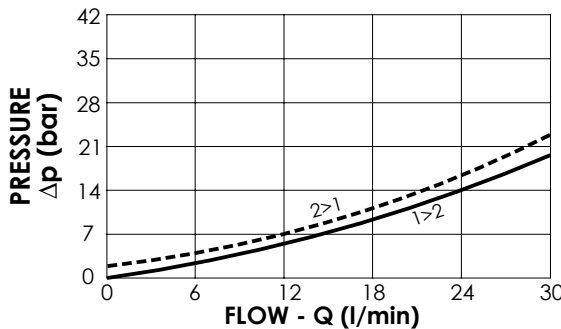

ORDERING CODES

Quick code	Description	Pilot ratio	Main ports size	Standard setting (bar, Q=5 l/min)	Adjust. range (bar)	Pressure increase (bar/turn)
MB000917	MBDN-030-LTNR-04-N06-N210	4:1	A,B,P,T: CETOP 3	200	70-210	93,5

MODULAR VALVE FOR CETOP

MBDN-060-ZTNR

DOUBLE ACTING
CETOP 3

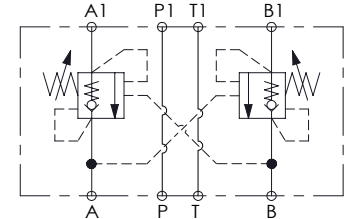
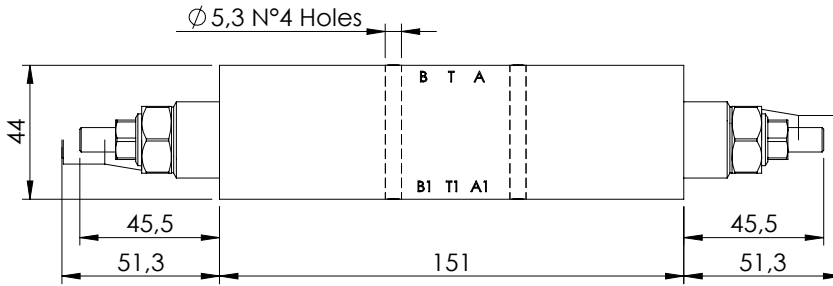
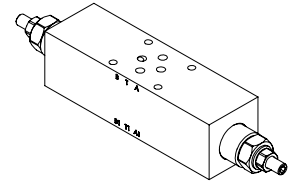
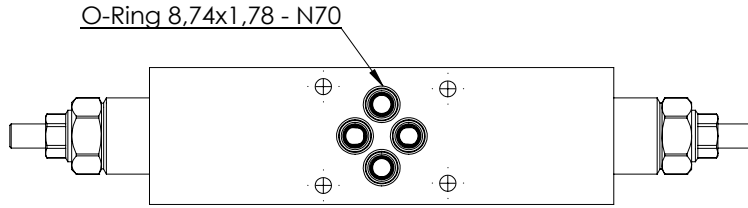

SPECIFICATIONS

Max. operating pressure:	350 bar
Rated flow:	60 l/min
Manifold:	Aluminium
Weight:	1,03 kg

SEALING CAP

Ordering code:
AT000020

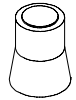

NOTES

Setting: at least 1.3 times the load induced pressure

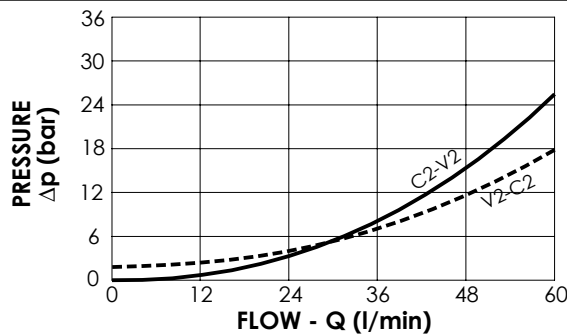
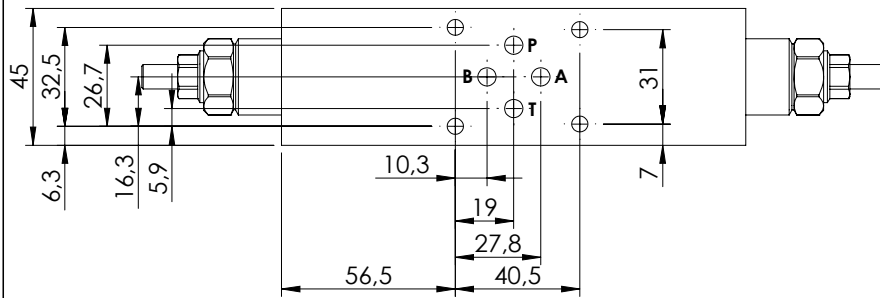

ORDERING CODES

Quick code	Description	Pilot ratio	Main ports size	Standard setting (bar, Q=5 l/min)	Adjust. range (bar)	Pressure increase (bar/turn)
MB000517	MBDN-060-ZTNR-04-N06-N350	4,2:1	A,B,P,T: CETOP 3	350	100-350	138
MB000546	MBDN-060-ZTNR-04-N06-N200	4,2:1	A,B,P,T: CETOP 3	200	60-210	62

MODULAR VALVE FOR CETOP

MBDN-060-ATNR

**DOUBLE ACTING
CETOP 3**



O-Ring 8,74x1,78 - N70

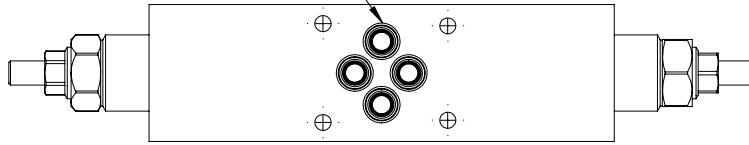

Ø 5,3 N°4 Holes

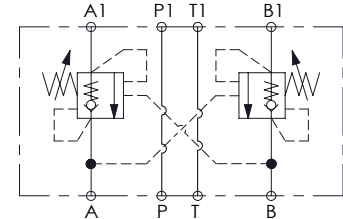
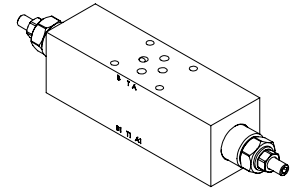
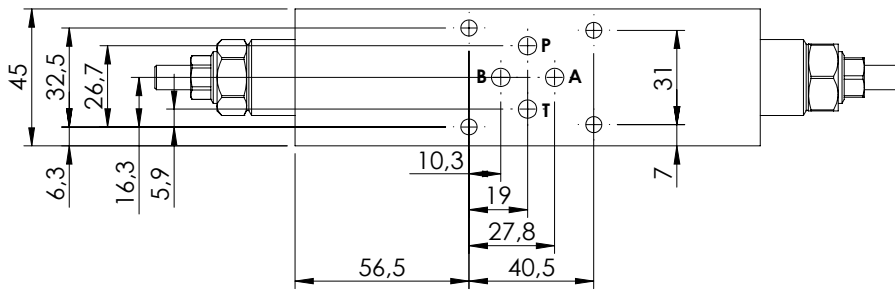
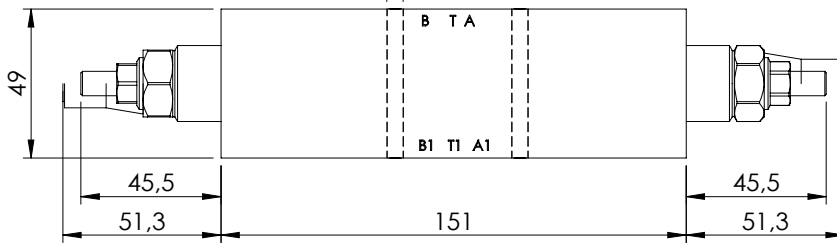

SPECIFICATIONS

Max. operating pressure:	350 bar
Rated flow:	60 l/min
Manifold:	Steel
Weight:	2,61 kg

SEALING CAP

Ordering code:
AT000020

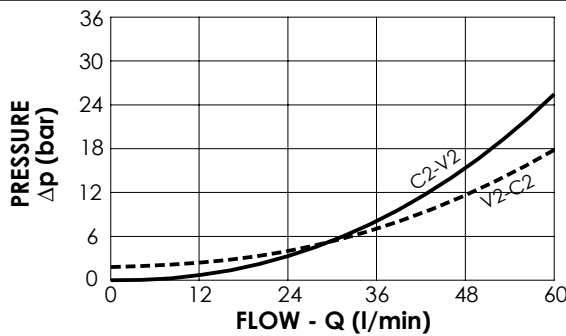
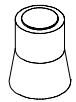

NOTES

Setting: at least 1.3 times the load induced pressure

ORDERING CODES

Quick code	Description	Pilot ratio	Main ports size	Standard setting (bar, Q=5 l/min)	Adjust. range (bar)	Pressure increase (bar/turn)
MB000929	MBDN-060-ATNR-04-N06-N350	4,2:1	A,B,P,T: CETOP 3	350	100-350	138
MB000774	MBDN-060-ATNR-04-N06-N200	4,2:1	A,B,P,T: CETOP 3	200	50-210	62

MODULAR VALVE FOR CETOP

MBDN-100-ZTNR

DOUBLE ACTING
CETOP 5



O-Ring 12,42x1,78 - N70

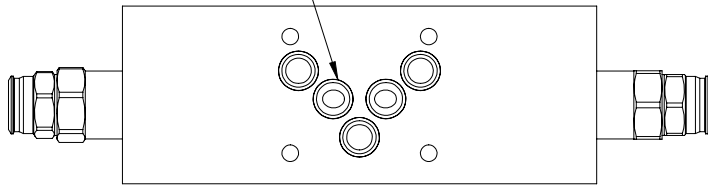

∅ 6,5 N°4 Holes

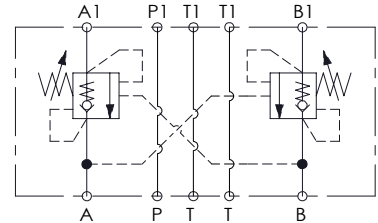
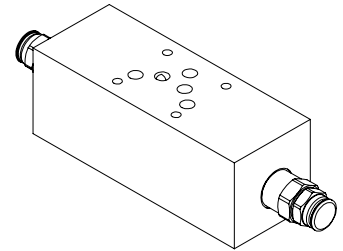
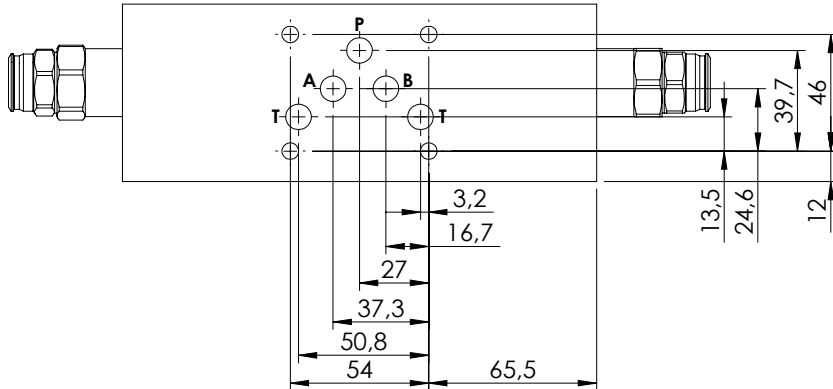
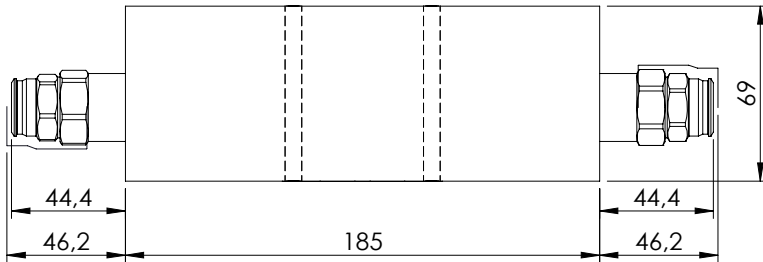

SPECIFICATIONS

Max. operating pressure:	350 bar
Rated flow:	100 l/min
Manifold:	Aluminium
Weight:	2,64 kg

SEALING CAP

Ordering code:
PT000243

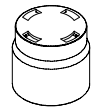

NOTES

Setting: at least 1.3 times the load induced pressure

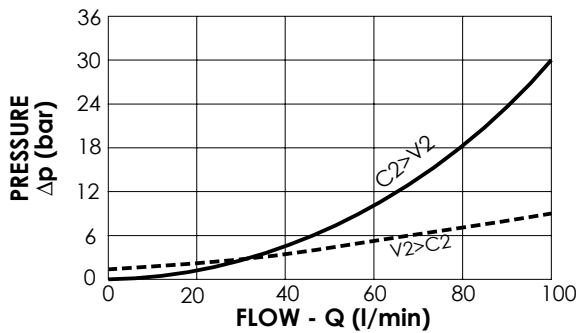

ORDERING CODES

Quick code	Description	Pilot ratio	Main ports size	Standard setting (bar, Q=5 l/min)	Adjust. range (bar)	Pressure increase (bar/turn)
MB000916	MBDN-100-ZTNR-04-N10-N350	4:1	A,B,P,T: CETOP 5	350	100-350	118

OVERCENTRE VALVE

MBDP-060-ZTNR

DOUBLE ACTING
CETOP 3



O-Ring 8,74x1,78 - N70

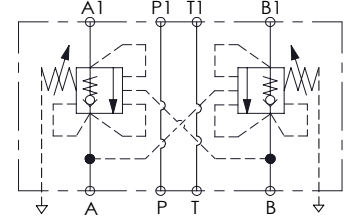
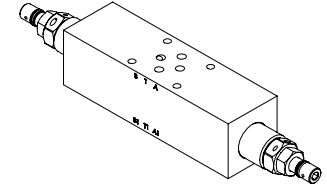
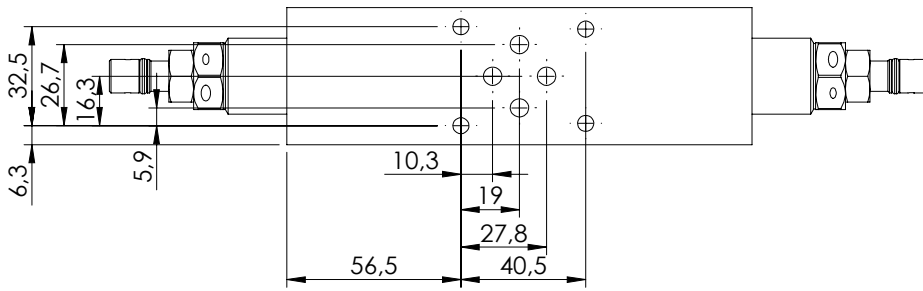
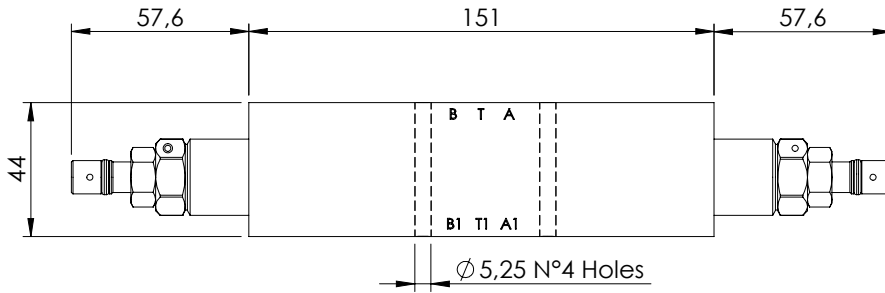
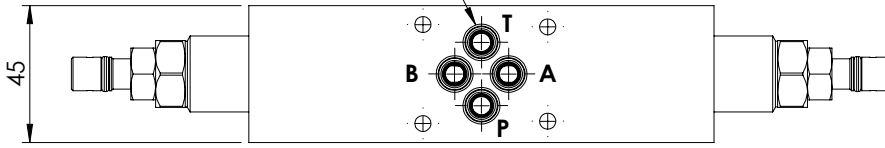

SPECIFICATIONS

Max. operating pressure:	350 bar
Rated flow:	60 l/min
Manifold:	Aluminium
Weight:	1,09 kg

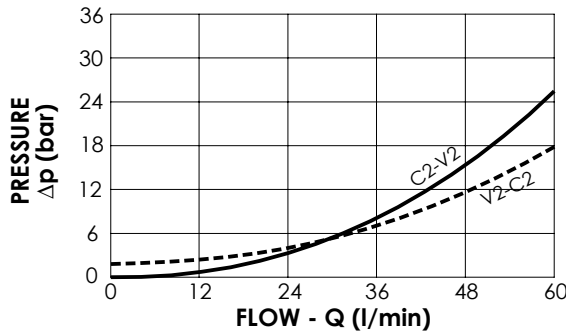

NOTES

Setting: at least 1.3 times the load induced pressure

ORDERING CODES

Quick code	Description	Pilot ratio	Main ports size	Standard setting (bar, Q=5 l/min)	Adjust. range (bar)	Pressure increase (bar/turn)
MB000454	MBDP-060-ZTNR-04-N06-N350	4,2:1	A,B,P,T: CETOP 3	350	100-350	166

MODULAR VALVE FOR CETOP

MBDT-100-ARNR

CETOP 5

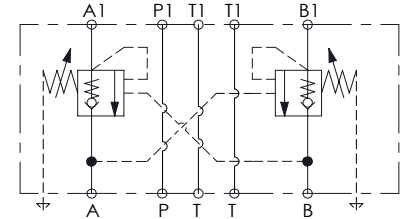
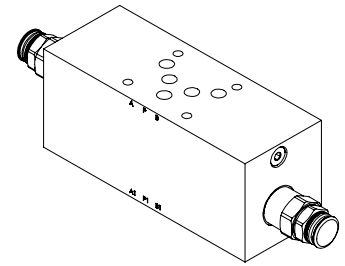
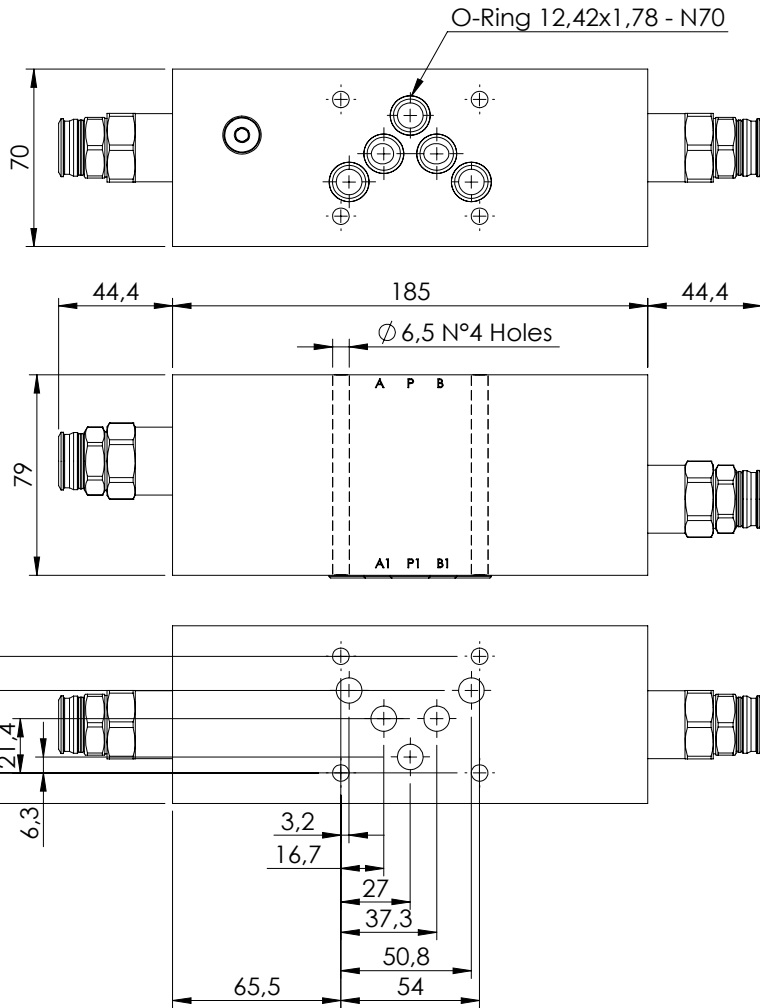

SPECIFICATIONS

Max. operating pressure:	350 bar
Rated flow:	100 l/min
Manifold:	Steel
Weight:	7,7 kg

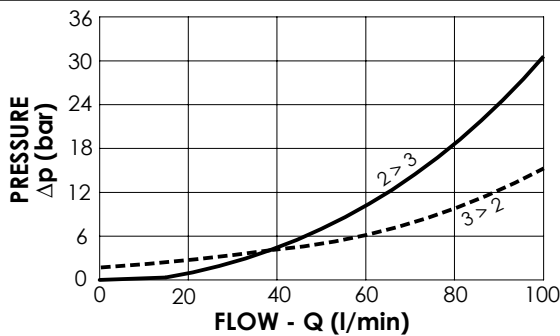

NOTES

Setting: at least 1.3 times the load induced pressure

ORDERING CODES

Quick code	Description	Pilot ratio	Main ports size	Standard setting (bar, Q=5 l/min)	Adjust. range (bar)	Pressure increase (bar/turn)
MB000930	MBDT-100-ATNR-04-N10-N350	3,8:1	A,B,P,T: CETOP 5	350	100-350	118