



**ATLANTIC**  
Fluid Tech



OIL SOLUTIONS

**PO Box 38**  
**Strathfieldsaye, VIC, 3551**  
**1800 OIL SOL**  
**1800 645 765**

**[sales@oilsolutions.com.au](mailto:sales@oilsolutions.com.au)**

**[www.oilsolutions.com.au](http://www.oilsolutions.com.au)**

**"For All Your Hydraulic Needs"**

**SECTION**  
**3**

**Sequence**  
**Valves**

**SECTION 3**

**SEQUENCE VALVES**



Hydraulic scheme	Valve description	Valve type	Rated flow (l/min)	Max. pressure (bar)	Installation	Main port size or cavity type	Page
	KPSN-030-DPNA	Direct acting, stabilized piston, not compensated	30	350	In line	G3/8"	3.01.010
	KPSN-030-DPNA	Direct acting, stabilized piston, not compensated	30	350	In line	G1/2"	3.01.020
	CPSN-060-DPGD	Direct acting, with anti-cavitation	60	420	Sleve	G3/8"	3.01.030
	KPST-030-DPNA	Direct acting, stabilized piston, compensated	30	350	In line	G3/8"	3.02.040
	KPST-030-DPNA	Direct acting, stabilized piston, compensated	30	350	In line	G1/2"	3.02.050
	CPST-060-DHLD	Differential, compensated	60	350	Sleve	G3/8"	3.02.060
	CPST-100-DHLD	Differential, compensated	100	350	Sleve	G1/2"	3.02.070
	KPEN-020-DPLD	Direct acting, solenoid by-pass	20	350	In line	G1/4"	3.03.080

SEQUENCE VALVE IN BODY

**KPSN-030-DPNA**

**DIRECT ACTING  
STABILIZED PISTON  
NOT COMPENSATED**

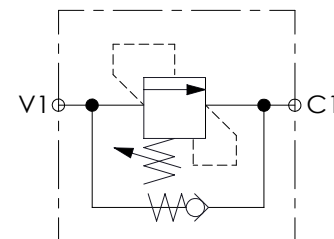
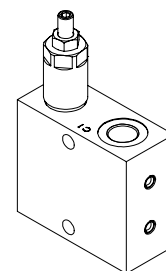
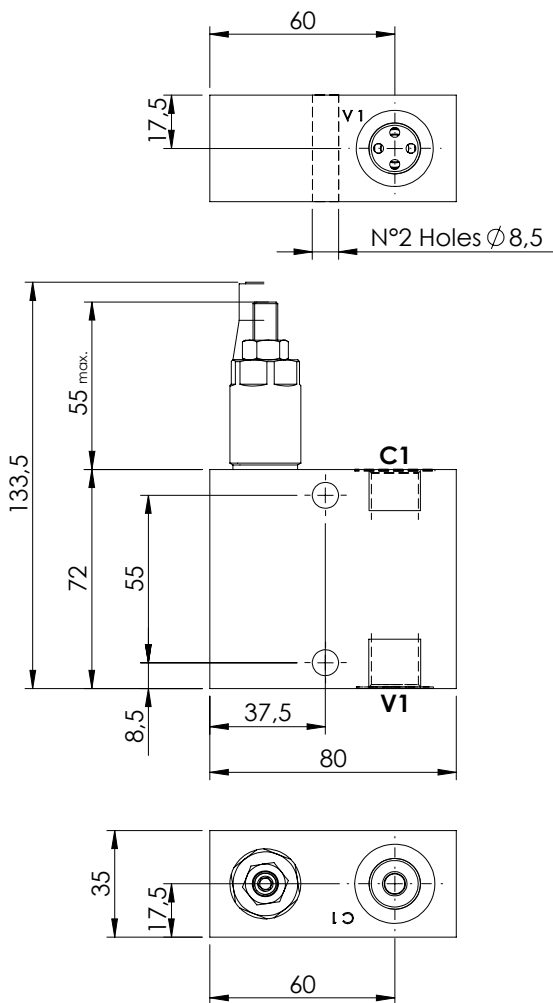

**SPECIFICATIONS**

Max. operating pressure:	350 bar
Rated flow:	30 l/min
Manifold:	Aluminium
Weight:	0,65 kg

**SEALING CAP**

Ordering code:  
**AT000020**

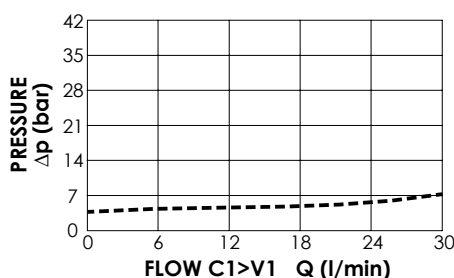
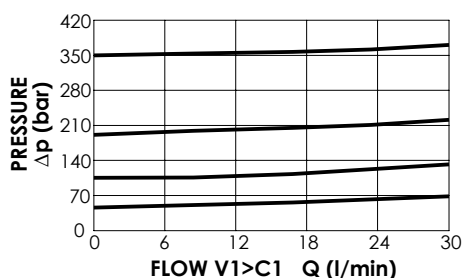
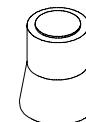

**ORDERING CODES**

Quick code	Description	Main ports size	Standard setting (bar, Q=5 l/min)	Adjustm. range (bar)	Pressure increase (bar/turn)
KP000036	KPSN-030-DPNA-HN-G38-N350	C1, V1: G 3/8"	350	100-350	91
KP000033	KPSN-030-DPNA-HN-G38-N200	C1, V1: G 3/8"	200	50-210	42
KP000035	KPSN-030-DPNA-HN-G38-N100	C1, V1: G 3/8"	100	30-100	20
KP000034	KPSN-030-DPNA-HN-G38-N050	C1, V1: G 3/8"	50	10-50	10

SEQUENCE VALVE IN BODY

**KPSN-030-DPNA**

**DIRECT ACTING  
STABILIZED PISTON  
NOT COMPENSATED**

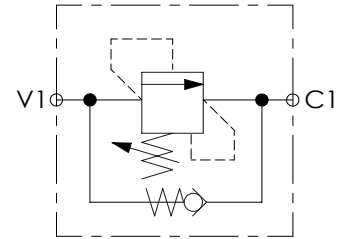
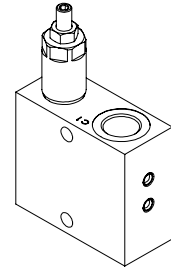
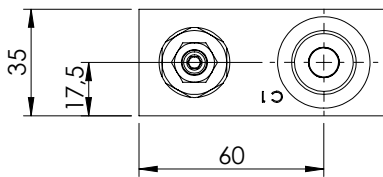
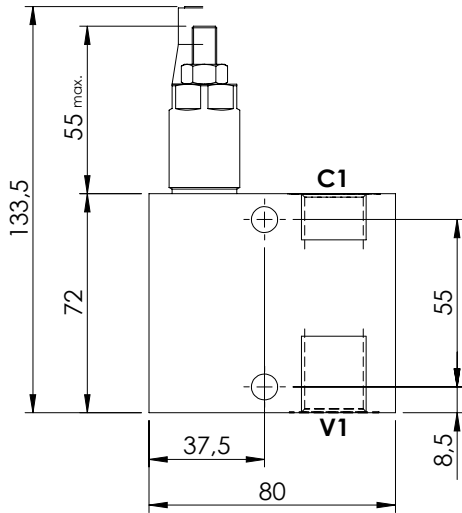
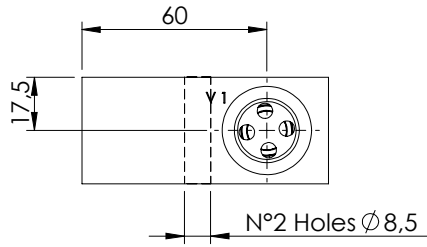

**SPECIFICATIONS**

Max. operating pressure:	350 bar
Rated flow:	30 l/min
Manifold:	Aluminium
Weight:	0,64 kg

**SEALING CAP**

Ordering code:  
**AT000020**

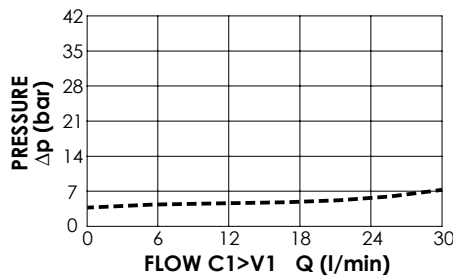
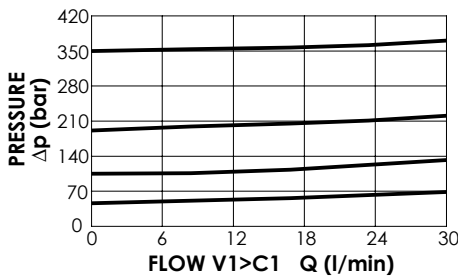
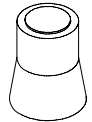

**ORDERING CODES**

Quick code	Description	Main ports size	Standard setting (bar, Q=5 l/min)	Adjustm. range (bar)	Pressure increase (bar/turn)
KP000061	KPSN-030-DPNA-HN-G12-N350	C1, V1: G 1/2"	350	100-350	91
KP000062	KPSN-030-DPNA-HN-G12-N200	C1, V1: G 1/2"	200	50-210	42
KP000060	KPSN-030-DPNA-HN-G12-N100	C1, V1: G 1/2"	100	30-100	20
KP000063	KPSN-030-DPNA-HN-G12-N050	C1, V1: G 1/2"	50	10-50	10

SEQUENCE SLEEVE VALVE

**CPSN-060-DPGD**

**DIRECT ACTING  
WITH ANTI-CAVITATION  
POPPET TYPE**

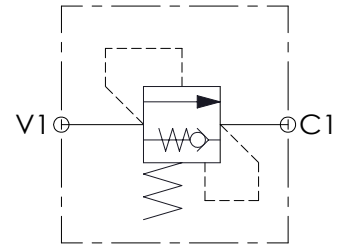
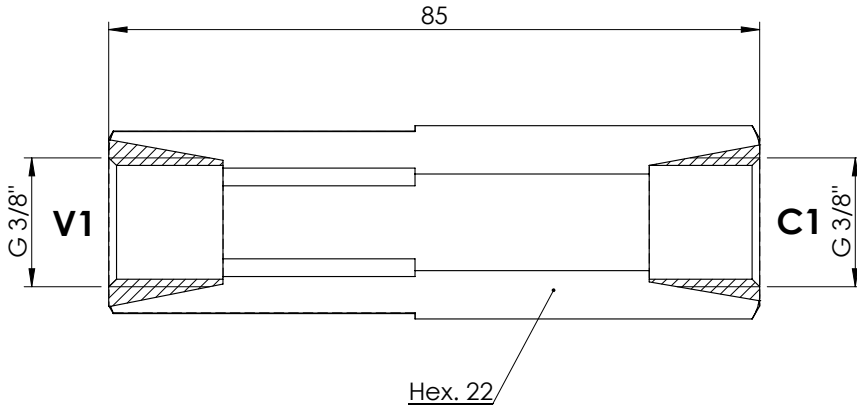
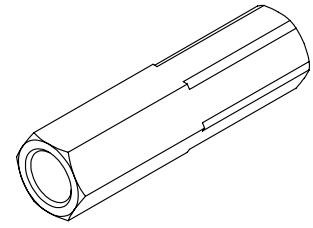

**SPECIFICATIONS**

Max. operating pressure:	350 bar
Rated flow:	60 l/min
Ports:	G 3/8"
Weight:	0.19 kg
Leakage:	1 cm <sup>3</sup> /min to 80% of nominal set point
Manifold:	Steel body

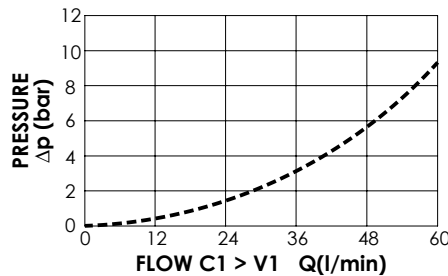
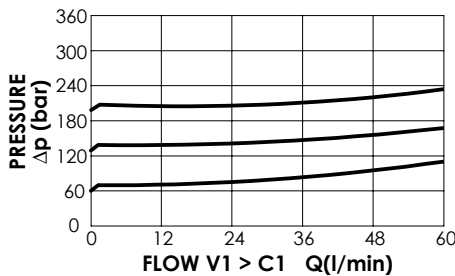

**ORDERING CODES**

Quick code	Spring range 20-70 bar setting (Q=1 l/min)	Quick code	Spring range 70-130 bar setting (Q=1 l/min)	Quick code	Spring range 130-210 bar setting (Q=1 l/min)
CP000194	20	CP000203	80	CP000210	140
CP000197	30	CP000204	90	CP000211	150
CP000198	40	CP000205	100	CP000212	160
CP000199	50	CP000206	110	CP000213	170
CP000200	60	CP000207	120	CP000214	180
CP000201	70	CP000208	130	CP000215	190
				CP000216	200
				CP000217	210

SEQUENCE VALVE IN BODY

**KPST-030-DPNA**

**DIRECT ACTING  
STABILIZED PISTON  
COMPENSATED**

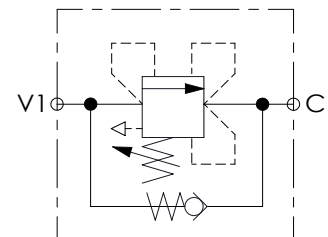
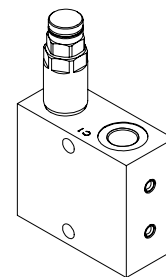
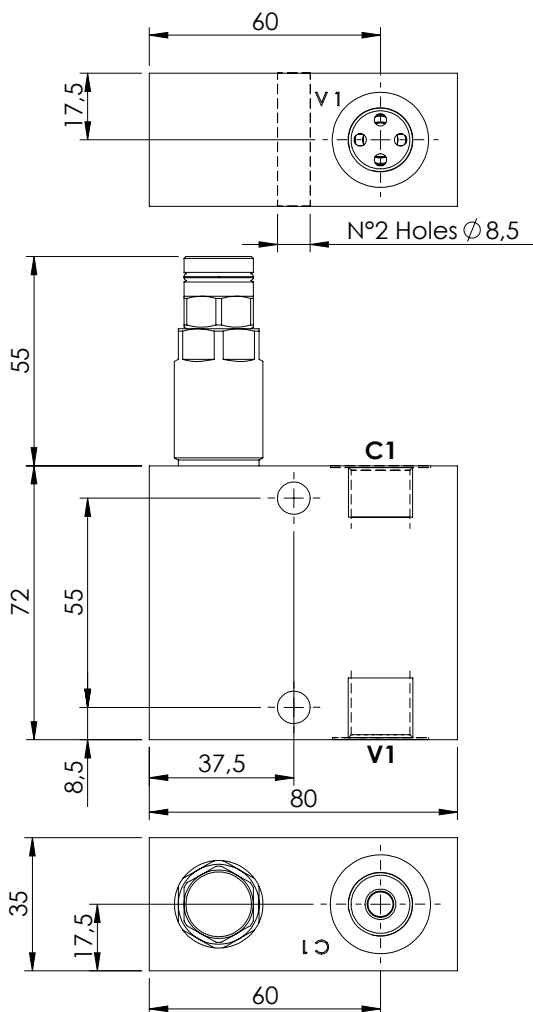

**SPECIFICATIONS**

Max. operating pressure:	350 bar
Rated flow:	30 l/min
Manifold:	Aluminium
Weight:	0,67 kg

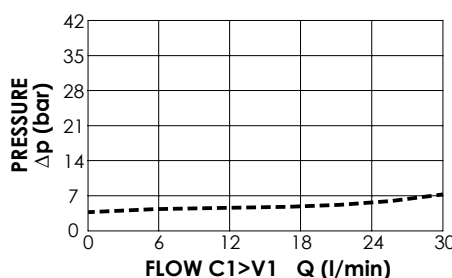
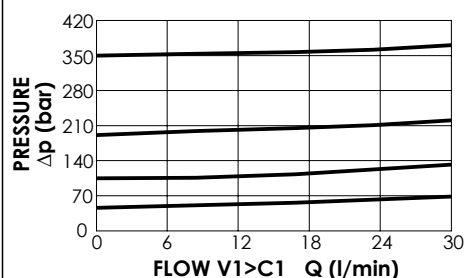

**ORDERING CODES**

Quick code	Description	Main ports size	Standard setting (bar, Q=5 l/min)	Adjustm. range (bar)	Pressure increase (bar/turn)
KP000079	KPST-030-DPNA-HN-G38-N350	C1, V1: G 3/8"	350	100-350	91
KP000080	KPST-030-DPNA-HN-G38-N200	C1, V1: G 3/8"	200	50-210	42
KP000081	KPST-030-DPNA-HN-G38-N100	C1, V1: G 3/8"	100	30-100	20
KP000082	KPST-030-DPNA-HN-G38-N050	C1, V1: G 3/8"	50	10-50	10

SEQUENCE VALVE IN BODY

**KPST-030-DPNA**

**DIRECT ACTING  
STABILIZED PISTON  
COMPENSATED**

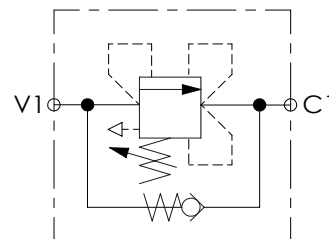
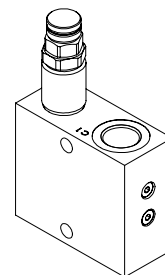
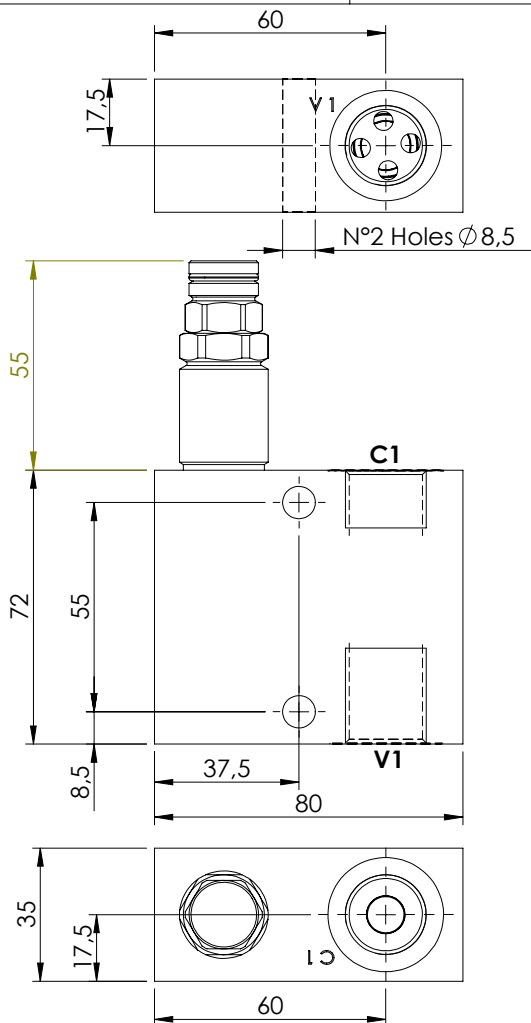

**SPECIFICATIONS**

Max. operating pressure:	350 bar
Rated flow:	30 l/min
Manifold:	Aluminium
Weight:	0,67 kg

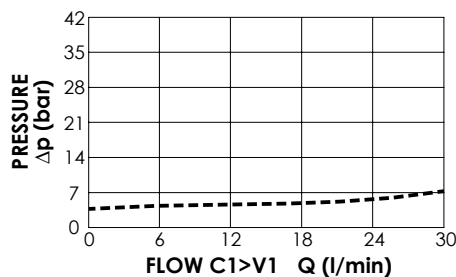
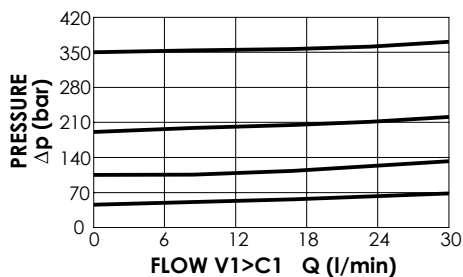

**ORDERING CODES**

Quick code	Description	Main ports size	Standard setting (bar, Q=5 l/min)	Adjustm. range (bar)	Pressure increase (bar/turn)
KP000083	KPST-030-DPNA-HN-G12-N350	C1,V1 : G 1/2"	350	100-350	91
KP000084	KPST-030-DPNA-HN-G12-N200	C1,V1 : G 1/2"	200	50-210	42
KP000085	KPST-030-DPNA-HN-G12-N100	C1,V1 : G 1/2"	100	30-100	20
KP000086	KPST-030-DPNA-HN-G12-N050	C1,V1 : G 1/2"	50	5-50	10

SEQUENCE VALVE

**CPST-060-DHLD**

DIFFERENTIAL AREA  
COMPENSATED

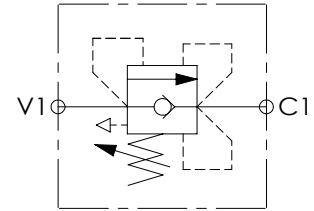
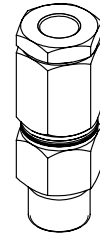
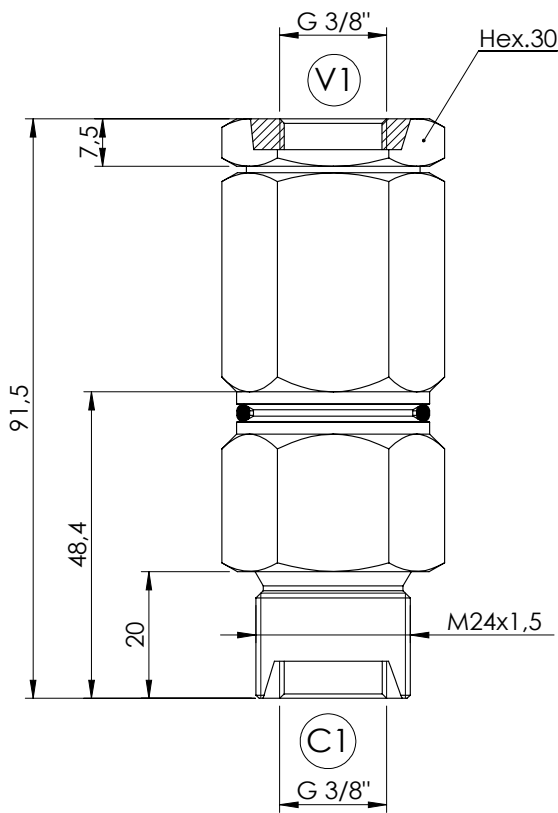

**SPECIFICATIONS**

Max. operating pressure:	350 bar
Rated flow:	60 l/min
Body:	Steel
Weight:	0,39 kg

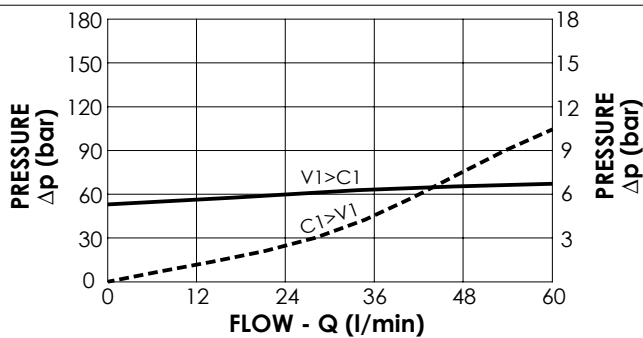

**ORDERING CODES**

Quick code	Description	Port size	Standard setting (bar, Q=5 l/min)	Adjust. range (bar)	Pressure increase (bar/turn)
CP000091	CPST-060-DHLD-GN-G38-N100	V1,C1 : G 3/8"	100	50-140	26
CP000435	CPST-060-DHLD-GN-G38-N120	V1,C1 : G 3/8"	120	50-140	26



SEQUENCE VALVE

**CPST-100-DHLD**

**DIFFERENTIAL AREA  
POPET TYPE  
COMPENSATED**

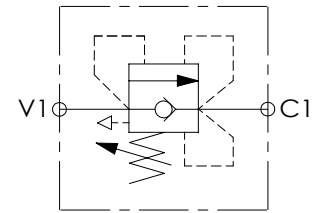
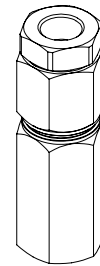
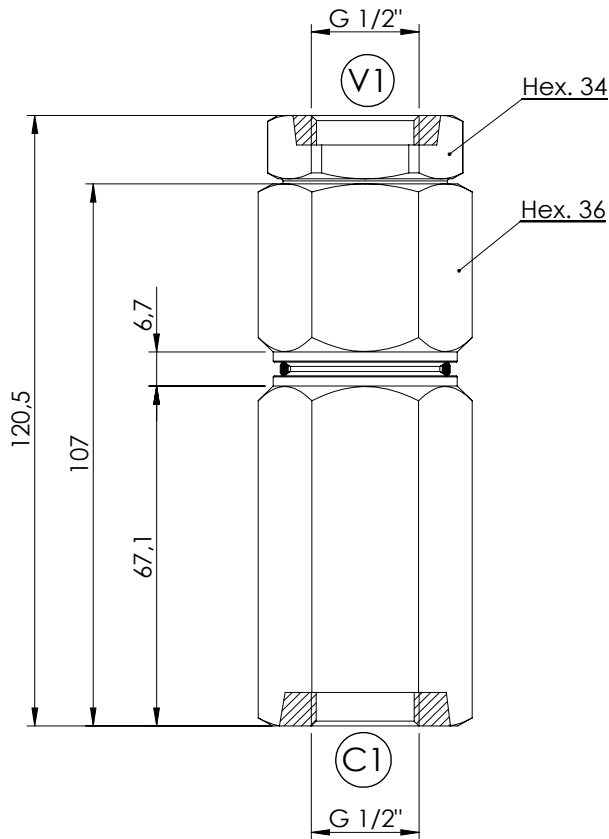

**SPECIFICATIONS**

Max. operating pressure:	350 bar
Rated flow:	100 l/min
Body:	Steel
Weight:	0,82 kg

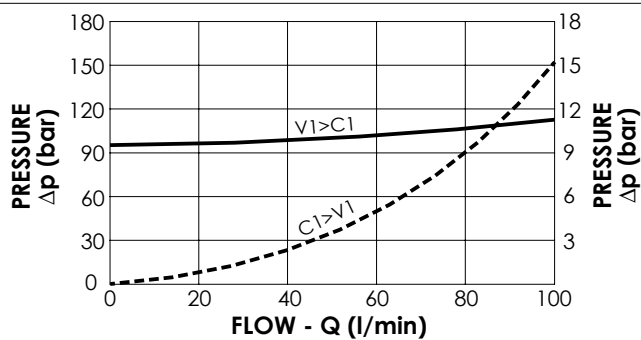

**ORDERING CODES**

Quick code	Description	Port size	Standard setting (bar, Q=5 l/min)	Adjust. range (bar)	Pressure increase (bar/turn)
CP000092	CPST-100-DHLD-GN-G12-N140	V1,C1: $G\ 1/2"$	100	50 - 140	27
CP000269	CPST-100-DHLD-GN-G12-N220	V1,C1: $G\ 1/2"$	200	100 - 220	39

SEQUENCE VALVE

**KPEN-020-DPLD**

**DIRECT ACTING  
SOLENOID BY-PASS**

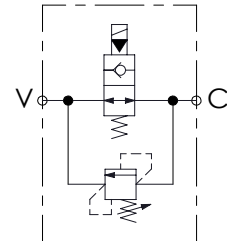
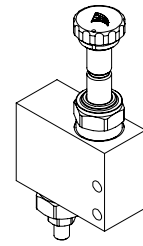
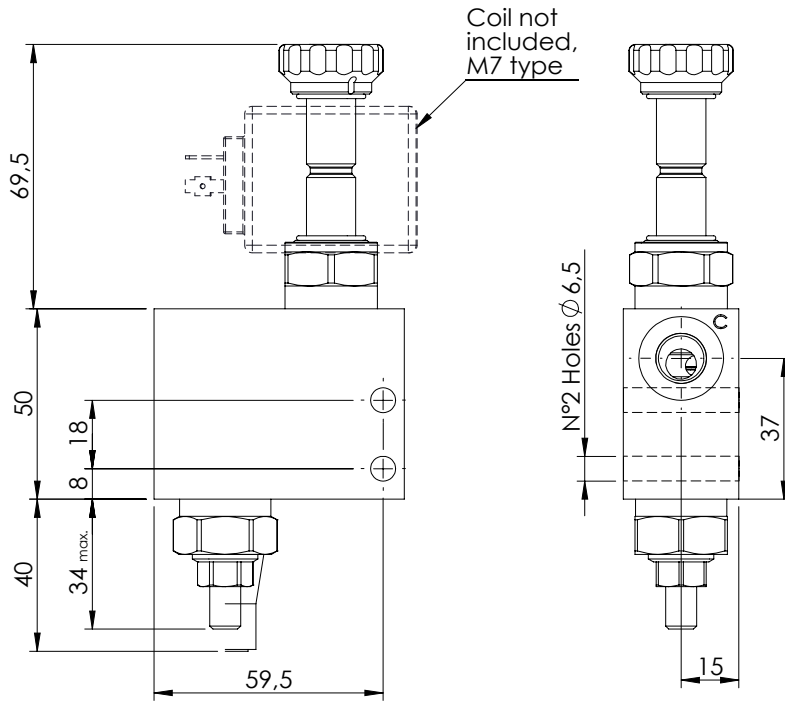
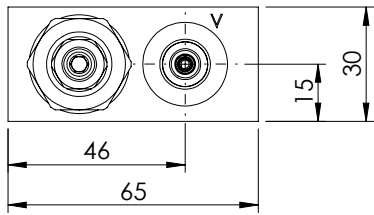

**SPECIFICATIONS**

Max. operating pressure:	350 bar
Rated flow:	20 l/min
Manifold:	Steel
Weight:	0,83 kg

**SEALING CAP**

Ordering code:  
**AT000020**

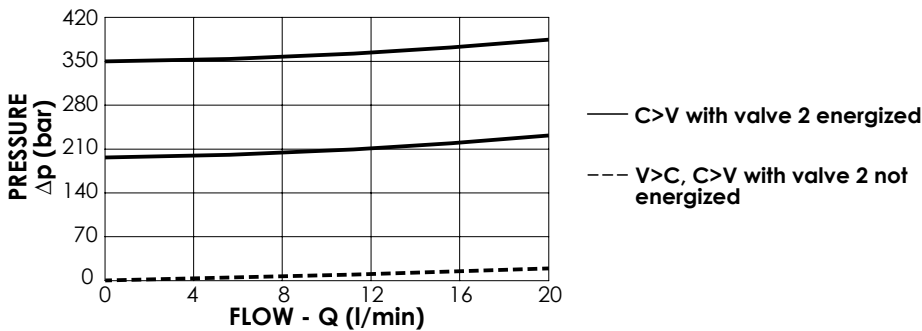
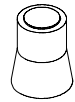

**ORDERING CODES**

Quick code	Description	Main ports size	Standard setting (bar, Q=5 l/min)	Adjustm. range (bar)	Pressure increase (bar/turn)
KP000109	KPEN-020-DPLD-SN-G14-N350	G 1/4"	350	175-350	177
KP000110	KPEN-020-DPLD-SN-G14-N210	G 1/4"	200	105-210	80