



# Level- and temperature switch

## Nivotemp NT 61D, Nivovent NV 71D

### Installation and Operation Instructions

Original instructions



1800-OILSOL  
1800-645765

<https://oilsolutions.com.au/>

[sales@oilsolutions.com.au](mailto:sales@oilsolutions.com.au)





Bühler Technologies GmbH, Harkortstr. 29, D-40880 Ratingen  
Tel. +49 (0) 21 02 / 49 89-0, Fax: +49 (0) 21 02 / 49 89-20  
Internet: [www.buehler-technologies.com](http://www.buehler-technologies.com)  
E-Mail: [fluidcontrol@buehler-technologies.com](mailto:fluidcontrol@buehler-technologies.com)

Read this instruction carefully prior to installation and/or use. Pay attention particularly to all advises and safety instructions to prevent injuries. Bühler Technologies can not be held responsible for misusing the product or unreliable function due to unauthorised modifications.

All rights reserved. Bühler Technologies GmbH 2020

Document information

Document No.....BE100017  
Version.....01/2020



1800-OILSOL  
1800-645765

<https://oilsolutions.com.au/>

[sales@oilsolutions.com.au](mailto:sales@oilsolutions.com.au)

# Contents

1	Introduction.....	3
1.1	Intended Use.....	3
1.2	Functionality.....	3
1.2.1	Liquid level monitoring .....	3
1.2.2	Temperature monitor .....	3
1.3	Design types.....	3
1.4	Model key NT61D .....	4
1.5	Model key NV71D .....	4
1.6	Scope of Delivery.....	4
2	Safety instructions.....	5
2.1	Important advice .....	5
2.2	General hazard warnings .....	6
3	Transport and storage .....	7
4	Setup and connection .....	8
4.1	Installation .....	8
4.2	Electrical connections .....	9
4.3	Information on the correct operation of reed contacts in Bühler level switches.....	9
4.4	Adjusting the level contacts.....	10
5	Operation and control .....	11
5.1	Start-up procedure .....	11
5.2	LED statuses .....	11
5.3	General key functions .....	12
5.4	Keylock enabled .....	12
5.5	Menu overview .....	13
5.6	Changing basic settings .....	14
5.6.1	Disabling normal error handling.....	14
5.6.2	Set temperature unit.....	14
5.6.3	Define switching outputs .....	15
5.6.4	Set display refresh rate .....	15
5.6.5	Enable/disable keylock.....	15
5.6.6	Restore factory settings (Reset).....	16
5.7	Switching outputs.....	17
5.7.1	Switching output x: Definition of the switching characteristic .....	18
5.7.2	Switching output x: Upper switching limit (switching point).....	19
5.7.3	Switching output x: Lower switching limit (switch-back point).....	19
5.7.4	Switching output x: Switch-on delay .....	20
5.7.5	Switching output x: Switch-back delay .....	20
5.7.6	Switching output x: Testing the switching output.....	20
5.7.7	Change status LED display function .....	21
5.8	Analogue outputs .....	22
5.8.1	Analogue output x: Assigning the upper limit.....	22
5.8.2	Analogue output x: Lower limit assignment .....	22
5.8.3	Analogue output x: Signal type assignment.....	23
5.8.4	Analogue output x: Testing the analogue output .....	23
5.9	Diagnostic options .....	23
5.9.1	View logbook.....	24
5.9.2	Maximum and minimum temperature .....	24
5.9.3	Define switching output to log .....	25
5.9.4	Delay for storing the Min/Max Temperature .....	25
6	Cleaning and Maintenance.....	26
6.1	Replacing the filter element.....	26
6.2	Adding small amounts of oil.....	26
7	Service and repair.....	27
7.1	Troubleshooting .....	27

7.2	Spare parts and accessories .....	28
8	Disposal .....	29
9	Appendices .....	30
9.1	Technical Data NT 61D .....	30
9.2	Technical Data NV 71D .....	32
9.3	Dimensions NV 71D .....	34
9.4	Standard pin assignment NT 61D .....	35
9.5	Standard pin assignment NV 71D .....	36
9.6	Current settings .....	37
9.7	Display ranges .....	37
9.8	Display resolution .....	37
9.9	Menu Sequence Overview .....	39
10	Attached documents .....	40



# 1 Introduction

## 1.1 Intended Use

Level switches are used to monitor the liquid level and temperature in fluid systems. Level switches must not be used in highly flammable or corrosive liquids.

The medium must not contain particles, particularly metallic particles, to prevent deposits on the float or between the float and switching tube. If necessary, filter the medium.

Please note the technical data in the appendix for the specific intended use, existing material combinations, as well as temperature limits.

### WARNING



All device models are solely intended for industrial applications. They are **not safety components**. The devices must not be used if failure or malfunction thereof jeopardises the safety and health of persons. Use in explosive areas is **prohibited**.

## 1.2 Functionality

### 1.2.1 Liquid level monitoring

The measuring tube is located inside the tank. The level switches are located inside the measuring tube. These are activated by a magnet inside the level switch float.

The contacts are mounted to a perforated rail spaced as specified in the purchase order, but can be moved if necessary.

The status of the switching outputs for the liquid level will be output to one of the plugs.

### 1.2.2 Temperature monitor

Temperature is monitored via temperature sensor (Pt100) inside the sensor tube. Depending on the version, there are several switching outputs combined with one analogue output (4 - 20 mA). The temperature is shown in the display.

Please note the technical data in the appendix.

## 1.3 Design types

The level switch is equipped with different switching and analogue outputs based on the configuration. The outputs are freely programmable.

### The Nivovent type can be equipped with the following options:

<b>VS</b>	Optical contamination indicator for the vent filter: analogue negative pressure display, display range 0.35 bar (5.1 PSI).
<b>BFA*</b>	Filling adapter incl. ribbed flange with screen insert: This option enables adding small amounts of oil through the vent filter housing. The selected version is built into the respective housing for this purpose.
<b>SSR*</b>	Stilling tube with centring disc and filling adapter: Just as with the BFA, this contains both the stilling tube option as well as the filler. The stilling tube is made from the same material as the selected immersion tube (MS/VA).
<b>MT</b>	for installation into the multiterminal: Here the basic version is built into the multiterminal (MT).
<b>MTS</b>	for installation into the multiterminal including stilling tube: In addition to the basic version, a stilling tube with centring disc is built into the multiterminal.
<b>FCT</b>	Fluidcontrolterminal: Here the fluid control terminal (FCT) is mounted directly onto the basic version.

\* not in conjunction with FCT and MT/MTS option

### The SSR option is available for the Nivotemp type.

Please refer to the type plate for your equipment configuration. In addition to the job number, this also contains the item number and type designation.



1800-OILSOL  
1800-645765

<https://oilsolutions.com.au/>

[sales@oilsolutions.com.au](mailto:sales@oilsolutions.com.au)

## 1.4 Model key NT61D

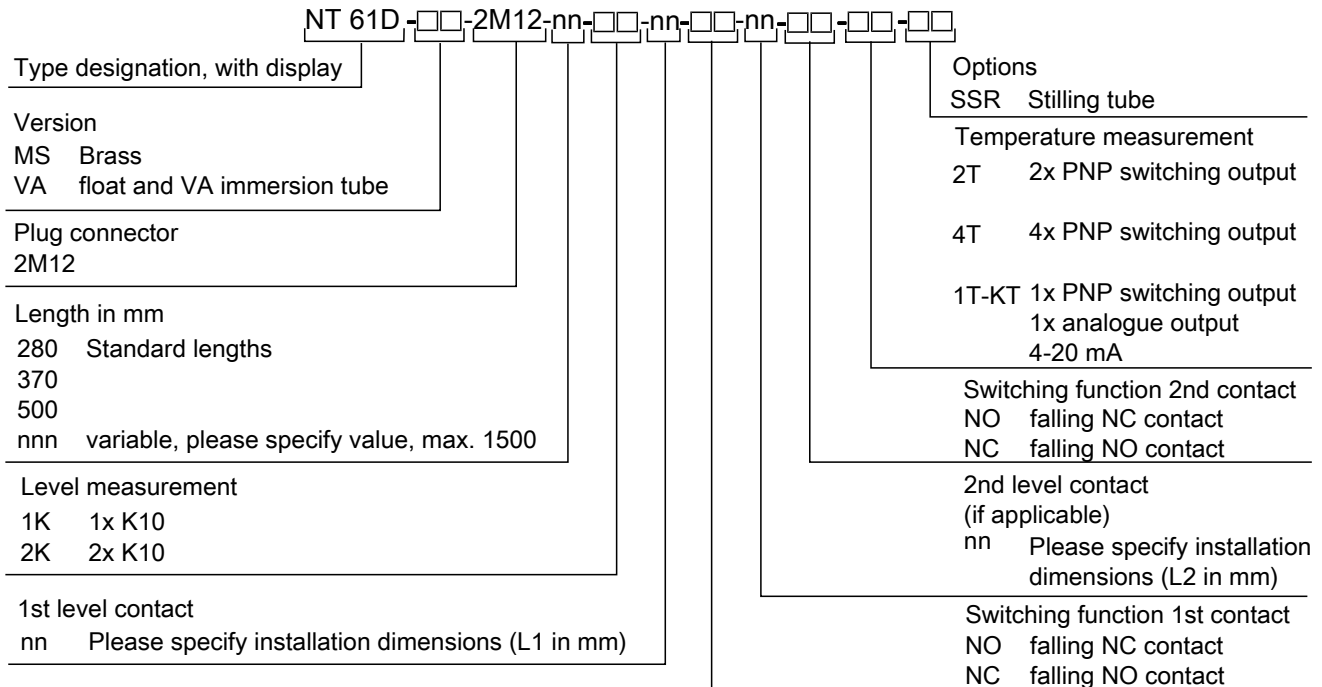

## 1.5 Model key NV71D

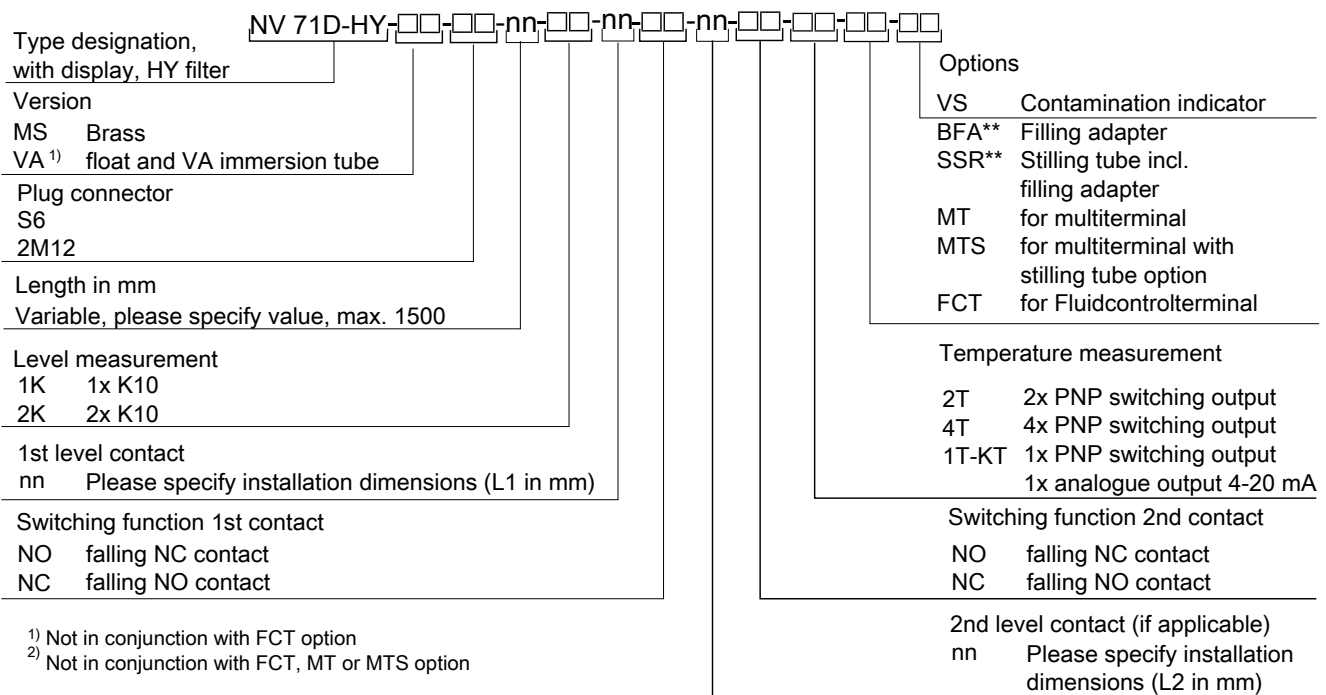

## 1.6 Scope of Delivery

- Level switch
- Product documentation
- Connection/mounting accessories (optional)



1800-OILSOL  
1800-645765

<https://oilsolutions.com.au/>

[sales@oilsolutions.com.au](mailto:sales@oilsolutions.com.au)

## 2 Safety instructions

### 2.1 Important advice

Operation of the device is only valid if:

- the product is used under the conditions described in the installation- and operation instruction, the intended application according to the type plate and the intended use. In case of unauthorized modifications done by the user Bühler Technologies GmbH can not be held responsible for any damage,
- when complying with the specifications and markings on the nameplates.
- the performance limits given in the datasheets and in the installation- and operation instruction are obeyed,
- monitoring devices and safety devices are installed properly,
- service and repair is carried out by Bühler Technologies GmbH,
- only original spare parts are used.

This manual is part of the equipment. The manufacturer keeps the right to modify specifications without advanced notice. Keep this manual for later use.

### Signal words for warnings

<b>DANGER</b>	Signal word for an imminent danger with high risk, resulting in severe injuries or death if not avoided.
<b>WARNING</b>	Signal word for a hazardous situation with medium risk, possibly resulting in severe injuries or death if not avoided.
<b>CAUTION</b>	Signal word for a hazardous situation with low risk, resulting in damaged to the device or the property or minor or medium injuries if not avoided.
<b>NOTICE</b>	Signal word for important information to the product.

### Warning signs

These instructions use the following warning signs:

	Warns of a general hazard		Unplug from mains
	Voltage warning		Wear respiratory equipment
	Warns not to inhale toxic gasses		Wear a safety mask
	Warns of corrosive liquids		Wear gloves
	General information		

## 2.2 General hazard warnings

The equipment must be installed by a professional familiar with the safety requirements and risks.

Be sure to observe the safety regulations and generally applicable rules of technology relevant for the installation site. Prevent malfunctions and avoid personal injuries and property damage.

### The operator of the system must ensure:

- Safety notices and operating instructions are available and observed,
- The respective national accident prevention regulations are observed,
- The permissible data and operational conditions are maintained,
- Safety guards are used and mandatory maintenance is performed,
- Legal regulations are observed during disposal,
- compliance with national installation regulations.

### Maintenance, Repair

Please note during maintenance and repairs:

- Repairs to the unit must be performed by Bühler authorised personnel.
- Only perform conversion-, maintenance or installation work described in these operating and installation instructions.
- Always use genuine spare parts.
- Do not install damaged or defective spare part. If necessary, visually inspect prior to installation to determine any obvious damage to the spare parts.

Always observe the applicable safety and operating regulations in the respective country of use when performing any type of maintenance.

The method for cleaning the devices must be adapted to the IP protection class of the devices. Do not use cleaners which could damage the device materials.

#### DANGER



#### Toxic, acidic gases/liquids

Protect yourself from toxic, corrosive gasses/liquids when performing any type of work. Wear appropriate protective equipment.





### 3 Transport and storage

Only transport the product inside the original packaging or a suitable alternative.

The equipment must be protected from moisture and heat when not in use. It must be stored in a covered, dry, dust-free room at room temperature.



1800-OILSOL  
1800-645765

<https://oilsolutions.com.au/>

[sales@oilsolutions.com.au](mailto:sales@oilsolutions.com.au)

## 4 Setup and connection

**DANGER**

**Electric voltage**



Risk of electric shock

- a) Always disconnect the unit from the mains before performing work.
- b) Secure the equipment from accidental restarting.
- c) The equipment may only be installed, maintained and put into operation by instructed, competent personnel.
- d) Always observe the applicable safety regulations for the operating site.



**DANGER**

**Toxic, acidic gases/liquids**



Protect yourself from toxic, corrosive gasses/liquids when performing any type of work. Wear appropriate protective equipment.



### 4.1 Installation

**Please note before installing the level switch!**

After transport and delivery of the level switch, the switching status of the bistable contacts may be different than required for proper operation.

Therefore slide the float for the level switch along the level switch tube from below immediately before installation.

This ensures all built-in bistable contacts have a clearly defined switching status (NC or NO).

For direct installation to the tank, insert the switching tube into the designated bore (per DIN 24557, Part 2) with rubberised cork seal on the tank. It secures to the flange using the included screws and seals. Please be sure the float can move freely and to leave enough space between the tank wall and add-ons.

After removing the float, where applicable, be sure the magnet inside the float is above the fluid level. This can easily be verified with a piece of iron to determine the magnet position inside the float.

**DANGER**

**Electric voltage**



**Risk of electric shock**

When connecting devices, please note the maximum voltages and currents (see technical data) and use the correct wire cross-sections and circuit breakers.

When selecting the connection lines, also note the maximum operating temperatures of the devices.

**Installation in special areas of application:**

If the device will be installed outdoors or in wet areas, the maximum operating voltage is max. 16 V DC effective or 35 V DC.



The flange-mounted display units can be swivelled vertically by approx. 270° so they are easier to read. Please note the built-in swivel stop. You will notice more resistance when reaching the stop. Turning it beyond this stop may damage the display unit.

## 4.2 Electrical connections

Electricity is supplied via plug connectors. Please refer to the appendix for installation dimensions, nominal voltage and plug configuration.

The temperature switching outputs are PNP transistors (see illustration):

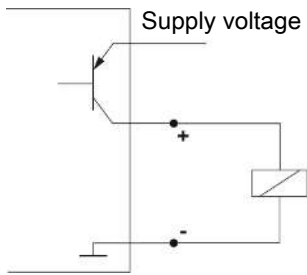

**Note:** When measuring the switching output with high-load measuring device inputs or when used as a frequency output, the load must be set to 10 kΩ between the output and earth (GND) to avoid faulty measurements.

## 4.3 Information on the correct operation of reed contacts in Bühler level switches

Based on their construction, reed contacts are very long lasting and reliable components. Yet the following should be considered when using them:

### Life of reed switches

The life of reed switches can be up to  $10^9$  cycles. This is reduced by high stress and / or incorrect or the absence of protective circuits when switching inductive, capacitive or lamp loads.

**It's therefore important to ensure NEVER to exceed one or several of the maximum approved limits, even temporarily, and to install a contact protective circuit for loads which are not purely ohmic. Using test lamps when installing the devices is also prohibited, as these can temporarily allow too much current to flow, which can damage the reed contacts. In this case non-volatile testing equipment should always be used.**

### Contact protective circuits for reed switches

For direct current voltage a recovery diode per figure A must be connected parallel to the contact.

For alternating current voltage an RC circuit per Figure B and Table 1 must be connected parallel to the contact.

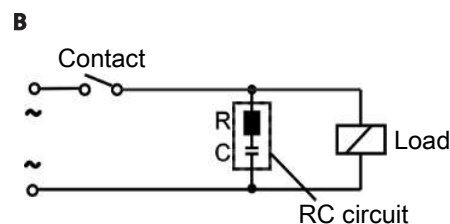
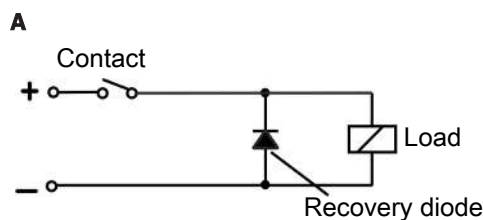

Load in VA	10		25		50		
	Voltage at contact V	R/Ohm	C/μF	R/Ohm	C/μF	R/Ohm	C/μF
24	24	22	0.022	1	0.1	1	0.47
60	60	120	0.0047	22	0.022	1	0.1
110	110	470	0.001	120	0.0047	22	0.022
230	230	470	0.001	470	0.001	120	0.0047

Please note the max. voltage/load ratings of the respective level contacts!

## Voltages and currents

All Bühler level contacts with reed switch can switch minimal Switching voltages of 10  $\mu$ V and minimal switching currents of 1  $\mu$ A.

The maximum values specified for the respective contact types apply.

Level contact with reed switches can therefore be used for SPS applications as well as for high loads (within the maximum limits) without hesitation.

## Contact material

All reed switches in Bühler level contacts use rhodium as the contact material for the actual contact areas.

## Magnetic fields

Avoid external magnetic fields, including from electric motors. These can interfere with the function of the reed switches.

## Mechanical loads

Do not expose the level switch to strong blows or bending.

## 4.4 Adjusting the level contacts

The level measurement contacts are mounted on a perforated rail inside the protective tube. These are arranged per order specifications but can be moved if necessary.

- Disconnect the voltage supply.
- Disconnect the plug.
- **Models NT61D:** Remove the two screws on the flange cover.
- **Models NV71D:** Remove filter cover and element. Unscrew and remove the filter case. Unscrew the flange cover from the level switch.
- Carefully pull the perforated rail with contacts out the top.
- Mark the original contact position.
- Lock the contacts in place in the desired positions. Please note the minimum spacing!

If the contacts are configured as NO contact (NO) or NC contact (NC), the contact function can be reversed by turning the contacts 180°. The housing has symbols for NC contact and NO contact as well as an arrow. The arrow, which points up when installed, indicates the current contact function. The contact logic assumes the level switch is installed in an empty tank, i.e. it is only in the operating position once filled.

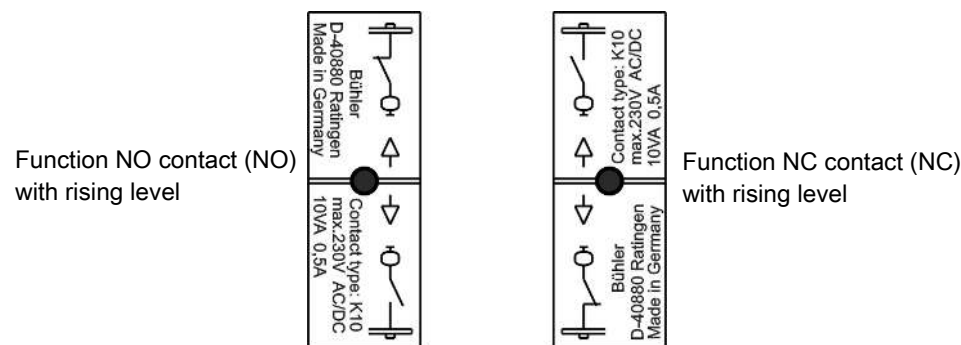

- Make a loop of the additional cable length and carefully slide the perforated rail in again.
- **Models NT61D:** Screw on the flange cover.
- **Models NV71D:** Screw on the flange cover. Screw on the filter case. Attach the filter cover and element.

### NOTICE



Ensure the seals are positioned correctly. Replace defective seals immediately!

## 5 Operation and control

### NOTICE



The device must not be operated beyond its specifications.

### 5.1 Start-up procedure

The device will automatically switch on when connected to power. It will first briefly display the software version, at which time the device will also check the built-in components. The display will then switch to displaying measurements.

The following describes the function of the display and control unit:

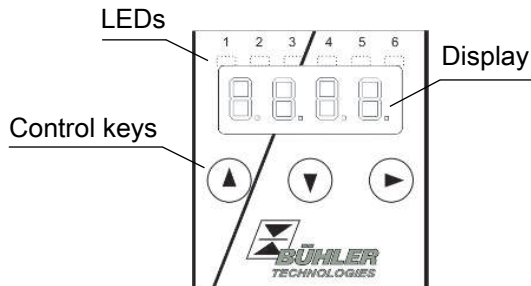

If an error message appears in the display during operation, please refer to the **Troubleshooting** table under chapter “Service and Repair”.

### 5.2 LED statuses

LEDs above the measurement display indicate the status of the temperature switching outputs. The LEDs are permanently assigned to the switching outputs.

The following table shows the factory settings:

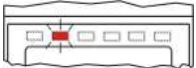
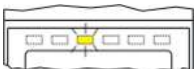
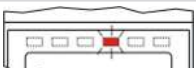
	LED 1 – yellow Status switching output 1
	LED 2 - red Status switching output 2 (if applicable)
	LED 3 – yellow Status switching output 3 (if applicable)
	LED 4 – red Status switching output 4 (if applicable)

The switching characteristics of the LED (on if switching contact closed or open) can be changed.

### 5.3 General key functions

The keys below the display are used for operation.

The menu controls are detailed in the following chapters.

Key	Mode	Function
▶	– Measurement display:	Change measured variables displayed.
	– In the menu:	Move down one menu level. Move up one menu level.
	– At the end of the menu:	 The display indicates the end of the menu.
	– Following input/selection:	Confirm and save a numerical value entered or a function selection. The display will flash if a parameter has been changed.
▲	– Measurement display:	Displays the configuration.
	– In the menu:	Scroll up menu item, numerical value or function selection. Holding the key will continuously scroll.
▼	– Measurement display:	Go to main menu.
	– In the menu:	Scroll down menu item, numerical value or function selection. Holding the key will continuously scroll.
▼ + ▶	– In the menu:	Exit the main / sub / drop-down menu and return to displaying the measurement without saving changes to the parameters.
▲ + ▶	– In the menu:	Move to the next higher menu level.
60 s no action	– In the menu:	Exit the main / sub/ drop-down menu.

To select a menu item and to enter values:

- Open the main menu with the ▼ key.
- Select the submenu with the ▼ and ▲ keys and open the submenu with the ▶ key.
- If necessary, select the next submenu with the ▼ and ▲ keys and open with the ▶ key.
- Select the desired menu item with the ▼ and ▲ keys and open the list of values with the ▶ key.
- Set the value with the ▼ and ▲ keys and confirm with the ▶ key. The new settings will be saved and the device will return to the submenu.
- Select the menu item EXIT to exit the submenu and confirm with the ▶ key. The device will return to the next menu level up or to the measurement display.

### 5.4 Keylock enabled

With the keylock enabled, selecting the menu with the ▼ key will display  in place of the main menu. The active digit will be indicated by a dot.

- Use the ▲ and ▼ keys to enter the code and confirm with the ▶ key. The active digit will move one place to the right. After entering the 3rd digit the main menu will open.

If the wrong code is entered, the device will return to the measurement display. If you forgot the password you can always enter master code 287 to access the menu.

You can cancel the keylock under *Loc* in submenu **Basic Settings Advanced Options** *bEF* and enter 000 to reset the code.

## 5.5 Menu overview

The menu structure is based on the VDMA standard sheet 24574-1. The menu structure is hierarchic. The top menu level contains the main menu items, e.g. *tENP*, *bEF*, *d, R*, *E*. Each main menu has additional submenu items.

The menu items may vary depending on the device configuration. Not all menu items described below will necessarily apply to your device. Press the ▲ key in display mode to open the configuration. A 4-digit code will appear, e.g.

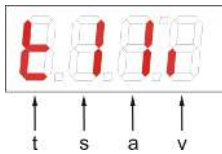

With the 4 digits tsav meaning:

t: Model

s: Number of switching outputs

a: Number of analogue outputs

v: Device installation type

t = temperature measurement

1, 2 or 4

0 for 1

i = standard installation (tank installation)

F = remote display

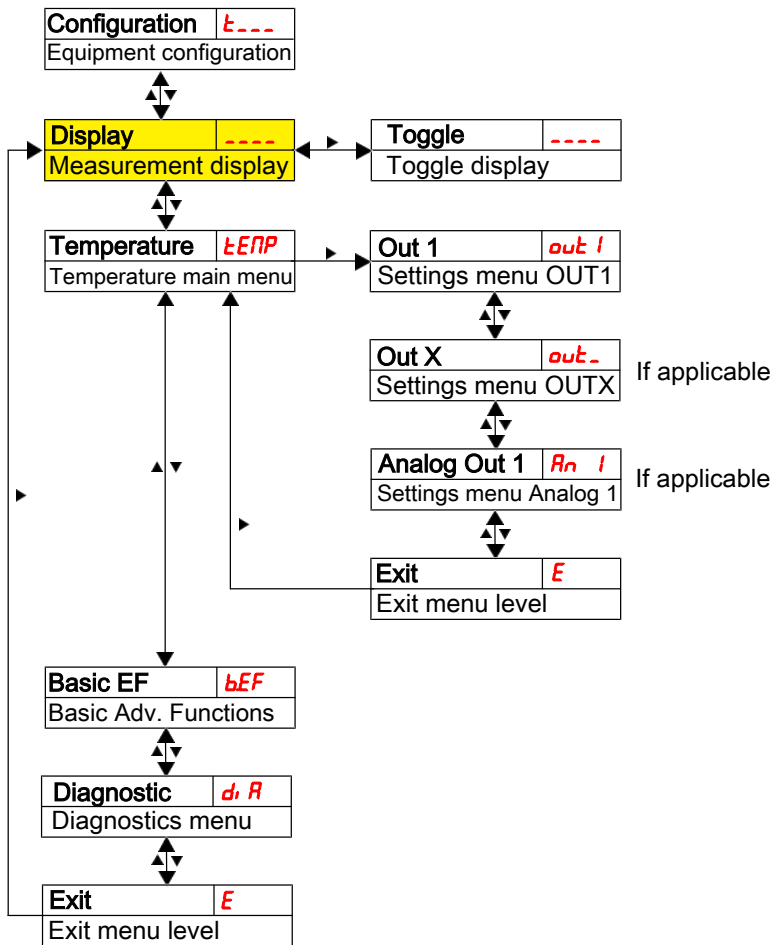

The individual menu items will not be shown if the option does not apply. Example: With a=0 the menu items for configuring the analogue output does not apply. You can then skip the description for this item.

The switching outputs or analogue outputs can be configured in the **Temperature** (*tENP*) main menu.

The basic device settings can be changed. General settings can be configured under **Basic Settings Advanced Functions** (*bEF*). These settings should be configured first, as they affect the displays and settings for the individual menus. These settings are e.g. the units used.

The **Diagnostic** (*d, R*) menu further contains diagnostics options.

**For the detailed illustration of the entire menu structure please refer to the original operating instructions at the end of this chapter.**

## 5.6 Changing basic settings

The general basic settings can be changed under menu **Basic Settings Extended Functions** (*bEF*). These settings will affect the measurement display and the configuration options in the various main menus. Here you can also change the switching output assignment.

- Press the ▼ key to open the main menu.
- Select menu item (*EF*) using the ▼ and ▲ keys and open the menu with the ► key.

### NOTICE



#### Disabling normal error handling

Disabling normal error handling and analysis could potentially cause dangerous operating states, dangers to the user or machines. Before using this option, review the hazard potential within the process. With this setting, Bühler Technologies GmbH assumes no liability for injuries to health or material damage caused by this setting.

### 5.6.1 Disabling normal error handling

Here you can enable/disable normal error handling and analysis

The function Disable error handling (*Errh*) is used to disable normal error handling and analysis. This may pose dangers to the user or machine.

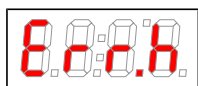
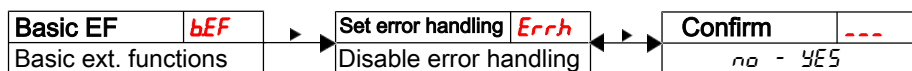

The options are:



Disables normal error handling.

Enables normal error handling (default)

Important note: When exceeding the measuring range or if sensor errors occur, the measurement will be frozen and all six LEDs in the status bar will blink. When the measurement returns to the permissible range the LEDs will stop blinking and the display will refresh again as usual.

### 5.6.2 Set temperature unit

This is where the unit symbol for the temperature is configured:



The options are:



Degrees  
Celsius

Degrees  
Fahrenheit

**Note:**

- Values are automatically converted and the measuring range adjusted. However, always check the respective switching points and switch-back points.



### 5.6.3 Define switching outputs

Here you can define the switching outputs.

Use the “Define switching outputs” function to define the switching outputs (*rou1* and *rou2*). The switching outputs can be configured as *Err*, *oil* and *TEMP*.

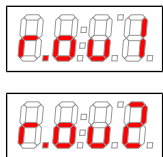
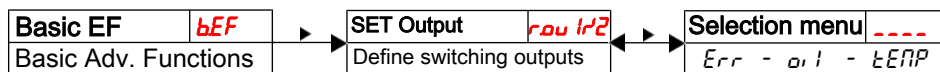

Options:  
*[Err, oil, TEMP]*

The options are:

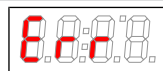

Err

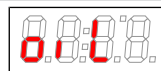

oil



TEMP

Note:

- Switching outputs 1 and 2 can alternatively be wired as error indicators. In this case the output will be connected as a NC contact which opens when exceeding the range or if an error occurs. The LED assigned to this output will generally not be activated, as all 6 LED's in the status bar will blink if an error occurs.
- When defining a switching output as an error indicator it will no longer be an option for normal switching output settings.

### 5.6.4 Set display refresh rate

The refresh rate of the display can be changed based on the application. The display can also be completely disabled. The LEDs will remain functional.



The options are:



fast



medium



slow



Display off

Note:

- Error messages will still appear, even with the display off.

### 5.6.5 Enable/disable keylock

The keylock can be enabled to prevent unauthorised changes to the device settings.

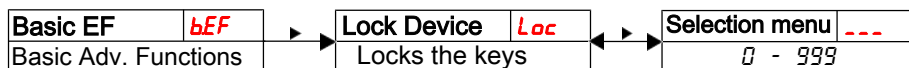

The keylock will be enabled after entering at least one digit > 0. A dot indicates the active digit during this input.



Setting range:  
000 to 999

- Use the **▶** key to open the list of values:
- Enter the digit using the **▼** and **▲** keys (0 to 9) and press the **▶** key to confirm. The active digit will move one place to the right.
- Lastly, press the **▶** key to confirm the code. The device will now return to the submenu.

Note:

- To disable the keylock enter: 000

## 5.6.6 Restore factory settings (Reset)

Use the Reset function (*rES*) to restore the factory settings. All changes will be lost. Since this will also reset the limits, you must check the temperature settings.

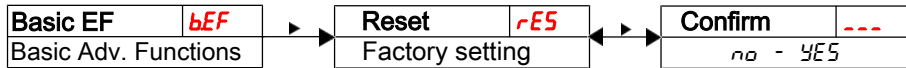

The options are:



Original status:  
No,  
keep current settings



Original status:  
Yes,  
reset settings to the factory defaults.

The factory settings are:

Definitions:

<i>SP X / rPX</i>	Switching point / switch-back point x
<i>dS X / drX</i>	Switch-on delay / switch-back delay for switching output x
<i>RxHi / RxLo</i>	Maximum and minimum measurement for output
<i>Rou X</i>	Analogue output signal type
<i>ou X</i>	Switching characteristic for switching output x
<i>tun</i>	Temperature unit
<i>d1 S</i>	Display refresh rate
<i>Lac</i>	Keylock
<i>Sdow</i>	Switching output logged
<i>dLm</i>	Delay for recording the minimum / maximum temperature

**Note:** For customer-specific specifications the factory preset may vary from those listed here.

### Basic settings:

#### Basic Settings

<i>tun</i>	<i>C</i>
<i>d1 S</i>	<i>FRSt</i>
<i>Lac</i>	<i>000</i>
<i>tcl *</i>	<i>000</i>
<i>tcl *</i>	<i>050:1</i>

\*for wall-mounting only

### Version with 1 switching output:

#### Switching outputs

<i>SP 1 / rP 1</i>	<i>50 / 45</i>
<i>dS 1 / dr 1 / ou 1</i>	<i>0 / 0 / Kno</i>

### Version with 2 switching outputs:

#### Switching outputs

<i>SP 1 / rP 1</i>	<i>50 / 45</i>
<i>dS 1 / dr 1 / ou 1</i>	<i>0 / 0 / Kno</i>
<i>SP 2 / rP 2</i>	<i>60 / 55</i>
<i>dS 2 / dr 2 / ou 2</i>	<i>0 / 0 / Kno</i>



1800-OILSOL  
1800-645765

<https://oilsolutions.com.au/>

[sales@oilsolutions.com.au](mailto:sales@oilsolutions.com.au)

**Version with 4 switching outputs:**

Switching outputs	
SP1 / rP1	50 / 45
dS1 / dr1 / ou1	0 / 0 / Hno
SP2 / rP2	60 / 55
dS2 / dr2 / ou2	0 / 0 / Hno
SP3 / rP3	70 / 65
dS3 / dr3 / ou3	0 / 0 / Hno
SP4 / rP4	80 / 75
dS4 / dr4 / ou4	0 / 0 / Hno

**Version with analogue output:**

Analogue output	
RAH / RLo / RAou1	0 / 100 / 1

**Diagnostic settings:**

Diagnostics	
Suou	out 1
dtm	00

**5.7 Switching outputs**

All switching outputs are configured the same way. The switching output number is therefore represented by x. Open the switching output to be configured from the menu for the respective measured variable.

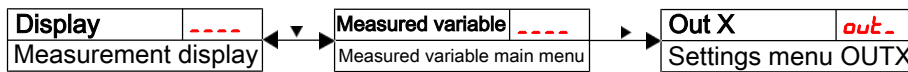

The switching output allocation and other basic settings related to all switching outputs can be configured in menu **Basic Settings Advanced Functions**.

Use submenu **Advanced Functions** to configure additional settings for each individual switching output which e.g. affect the switching characteristics of the output. The output can also be tested here.

## 5.7.1 Switching output x: Definition of the switching characteristic

The switching characteristic for the output can be configured under the following menu:



The options are:

### Hysteresis Function

NO contact or NC contact function when the output signal is set when exceeding the configured switching point. The output signal will be deleted if the value is below the configured switch-back point.



Hysteresis function as the NO contact

Here, NO contact ( $H_{no}$ ) means the PNP switching output is closed above switching point  $SP_x$  and opens below switching point  $rP_x$ .

Here, NC contact ( $H_{nc}$ ) means the PNP switching output is open above switching point  $SP_x$  and closes below switching point  $rP_x$ .

Also see the explanation in the drawing below.

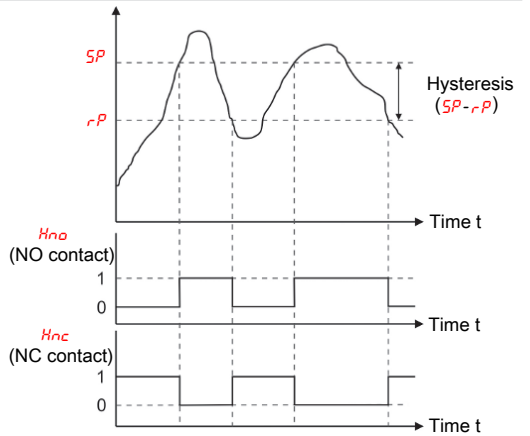

### Window function

NO contact or NC contact function defining a signal window. When the measuring window is reached the output signal is set and deleted upon exiting.



Window function as NO contact

Here, NO contact ( $F_{no}$ ) means the PNP switching output is closed if the value is within the window. Otherwise the switching output will be open.

Here, NC contact ( $F_{nc}$ ) means the PNP switching output is open if the value is within the window. Otherwise the switching output will be closed.

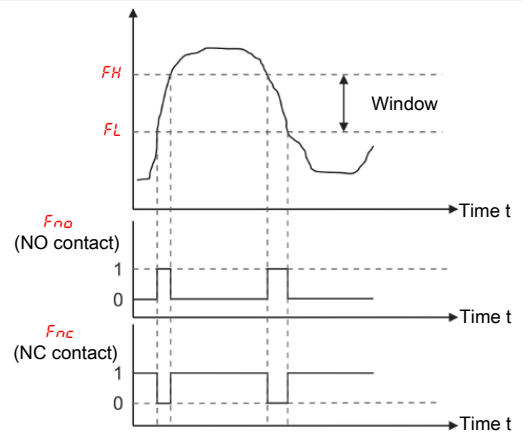

### Frequency output

If the output is defined as a frequency output, a square wave signal with a frequency between 1 Hz and 100 Hz proportional to the measurement will be output.

**Note:** To increase the slew rate of the square wave signal, we recommend loading the switching output with a load of 10 k $\Omega$ .



Frequency output

Example:  $F_{ILO} = 15\text{ }^\circ\text{C}$ ,  $F_{IHi} = 80\text{ }^\circ\text{C}$  with temperature  $T$  and frequency  $f$ :

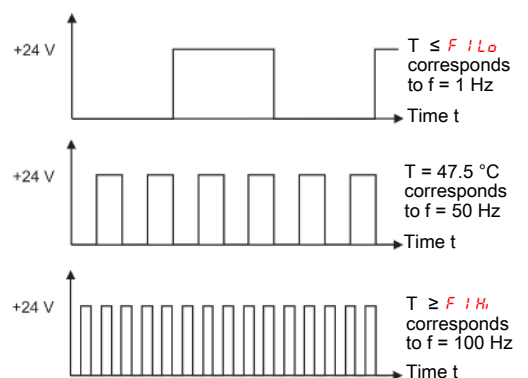

**Note:** The designation of the switching function may vary:

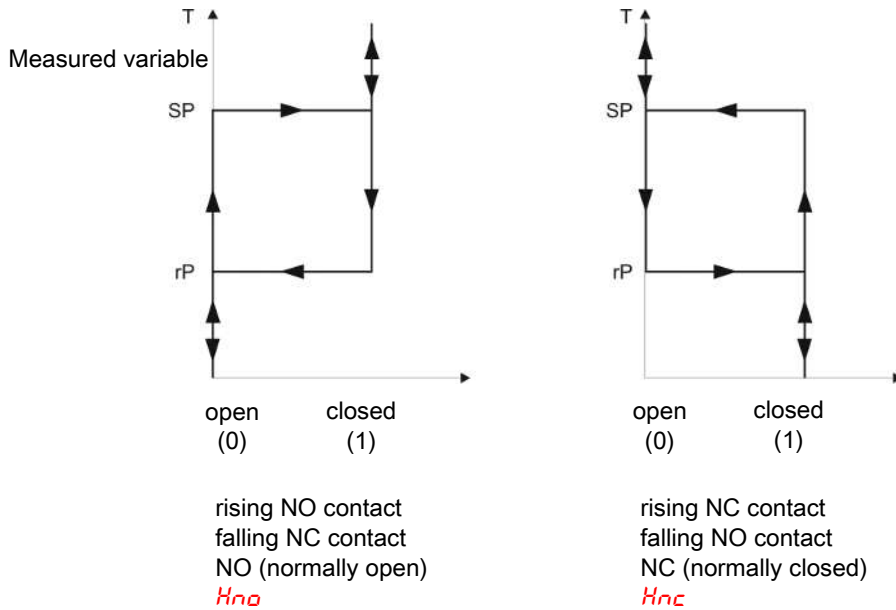

### 5.7.2 Switching output x: Upper switching limit (switching point)

The upper switching limit for switching output Out x can be defined with the following submenu:

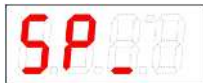
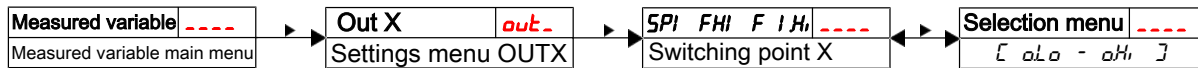

Switching point for OUT x

Setting range:  
0 °C to 100 °C  
(32 °F to 212 °F)

**Note:**

- The switching point must be set to within the range limits (see menu **Basic Settings Advanced Functions**).
- If switching output OUT x was assigned the function **Window**, will appear. The setting corresponds with the upper window limit.
- If switching output OUT x was assigned the function **Frequency output**, will appear. The setting corresponds to the frequency 100 Hz.

### 5.7.3 Switching output x: Lower switching limit (switch-back point)

The lower switching limit for switching output Out x can be defined with the following submenu:

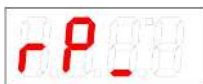
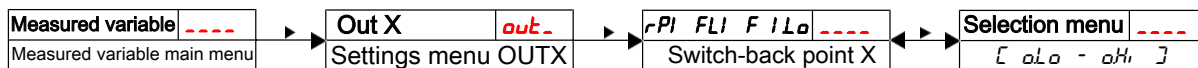

Switch-back point for OUT x

Setting range:  
0 °C to 100 °C  
(32 °F to 212 °F)

**Note:**

- The switch-back point must be set to within the range limits and must always be lower than the switching point.
- If switching output OUT x was assigned the function **Window**, will appear. The setting corresponds with the lower window limit.
- If switching output OUT x was assigned the function **Frequency output**, will appear. The setting corresponds to the frequency 1 Hz.

### 5.7.4 Switching output x: Switch-on delay

The menu **Advanced Functions** *EFx* is used to configure additional settings for switching output x. The submenu is at the second submenu level.

The switching and switch-back delay prevents the alarm being triggered too frequently in unstable conditions. The switching delay can be configured with the following menu:

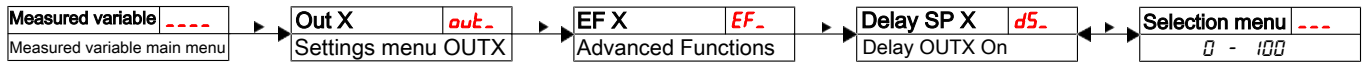

Time span in seconds during which the signal must be continuously present for the switching output to respond.

**Note:**

Setting range:  
0...100 seconds

- If switching output OUT x was assigned the function **Window**, the setting corresponds to the switch-on delay which detects valid reaching of the measuring window.
- If switching output OUT x was assigned the function **Frequency output**, this value will have no affect.

### 5.7.5 Switching output x: Switch-back delay

The switch-back delay can be configured with the following menu:

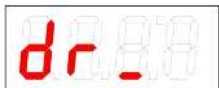
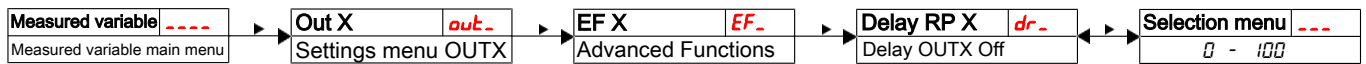

Switch-back signal delay for OUT x.

Time span in seconds during which the signal must be continuously present for the switching output to respond.

**Note:**

Setting range:  
0...100 seconds

- If switching output OUT x was assigned the function **Window**, the setting corresponds to the switch-on delay which detects valid closing of the measuring window.
- If switching output OUT x was assigned the function **Frequency output**, this value will have no affect.

### 5.7.6 Switching output x: Testing the switching output

The switching output test can be started with the following menu:

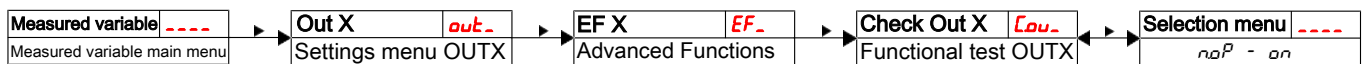

Switching output test option

Options when setting *ou 1* to *Hno* / *Hnc* / *Fno* / *Fnc*:



Normal switching output operation

Switching output permanently off disabled

Switching output permanently activated

Options when setting *ou 1* to *F? :*



Normal mode as frequency output

Output Frequency 1 Hz

Output Frequency 100 Hz



**Note:**

- **After completing the test, set the function to normal mode *noP*.**



## 5.7.7 Change status LED display function

The LEDs in the display indicate the switching status of the output. The following table shows how LEDs are allocated to the switching output:

Numbering LED	Switching output x	Assignment for 1 switching output	Assignment for 2 switching outputs	Assignment for 4 switching outputs
LED 1 2 3 4 5 6	1	LED 1 - yellow	LED 1 - yellow	LED 1 - yellow
	2		LED 2 - red	LED 2 - red
	3			LED 3 - yellow
	4			LED 4 - red

In the factory setting the LED indicates the physical status of the PNP switching output (switching output closed – LED on).

The logical indicator function may need to be different from the physical signal on the switching output. You can therefore also reverse this indication with this menu (switching output open – LED on).

### Example:





You have 2 switching outputs for the temperature, configured as:

- **Switching output 1:** Max contact, rising NO contact. The LED lights up when exceeding the maximum temperature and the temperature is higher than the desired range. So this LED lighting up indicates an “Error” status.
- **Switching output 2:** Min contact, rising NO contact. So in the factory setting, the LED lights up when exceeding the minimum temperature. So in this case the LED would light up if the status is okay.

The table shows an example with the factory setting and with inverted status function for LED3. The switching points are defined as:

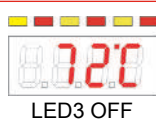
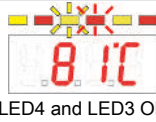
SP3 = 70 °C, rP3 = 65 °C

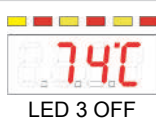
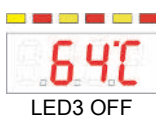
SP4 = 80 °C, rP4 = 75 °C

	Factory setting	Status function LED 3 inverted	State	Status
<b>A</b>	 LED3 ON	 LED3 OFF	Temperature rises to > 70 °C PNP switching output 3 closed	OK
<b>B</b>	 LED4 and LED3 ON	 only LED4 ON	Temperature rises to > 80 °C PNP switching output 4 closed	Error
<b>C</b>	 LED3 ON	 LED 3 OFF	Temperature falls to < 75 °C PNP switching output 4 open	OK
<b>D</b>	 LED3 OFF	 LED3 ON	Temperature falls to < 65 °C PNP switching output 3 open	Error

Here you can reverse the LED status function for a contact: the LED lights up if the contact is open, so below the minimum temperature, and the LED lighting up again indicates an “Error” status.

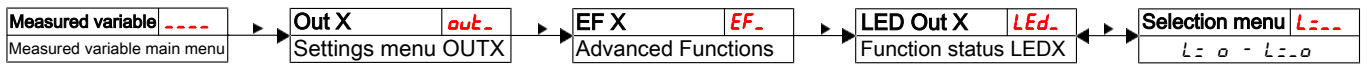

The options are:



LED = output;  
the LED lights up when the PNP switching output is closed.

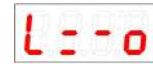

LED = -output;  
the LED lights up when the PNP switching output is open.

**NOTICE**



The display function of the status LED affects event logging! Please note chapter “Diagnostic options”.

## 5.8 Analogue outputs

### 5.8.1 Analogue output x: Assigning the upper limit

Used to configure at which temperature to output the maximum analogue signal. This is configured in menu:

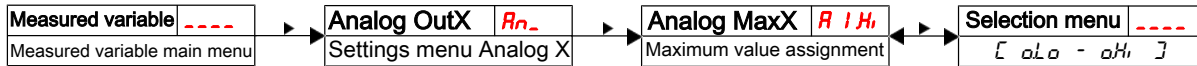

**Note:**

- The output range setting must not be less than 10 % of the measuring range:  $A.H. - A.Lo \geq 10\%$
- If the range is set too low, the analogue value output may have grades.

Setting range:  
0 °C to 100 °C  
(32 °F to 212 °F)

### 5.8.2 Analogue output x: Lower limit assignment

Used to configure at which temperature to output the minimum analogue signal. This is configured in menu:

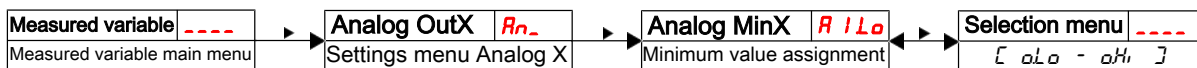

**Note:**

- The output range setting must not be less than 10 % of the measuring range:  $A.H. - A.Lo \geq 10\%$
- If the range is set too low, the analogue value output may have grades.

Setting range:  
0 °C to 100 °C  
(32 °F to 212 °F)



### 5.8.3 Analogue output x: Signal type assignment

The analogue output can be defined as a voltage or current output with different value ranges. This is configured in menu:

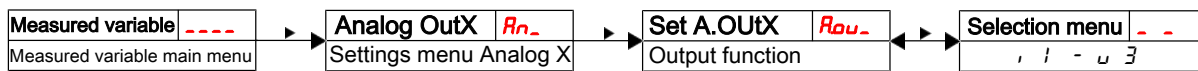

The options are:



4 mA to 20 mA



2 V to 10 V



0 V to 10 V



0 V to 5 V

### 5.8.4 Analogue output x: Testing the analogue output

The analogue output can be tested. The highest, mean and lowest analogue value can be output successively. This is configured in menu:

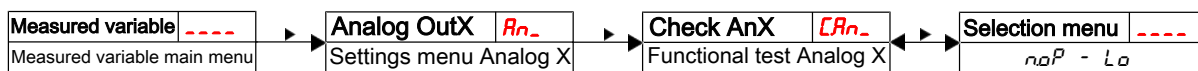

The options are:



Normal mode



Highest analogue value output



Mean analogue value output



Lowest analogue value output



**Note:**

- After completing the test, set the function to normal mode *noP*.

### 5.9 Diagnostic options

The device is able to log events for a switching output. The LED lighting up is considered an event. The logging of switching procedures therefore depends on how the LED switching function is configured.

The configuration and analysis can be carried out here.

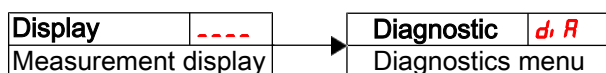

#### NOTICE



Only one switching output can be logged. The switching output to be logged is configured in menu item **Set Journal Out** (*5jou*).

- Press the ▼ key to open the main menu.
- Select menu item *di R* with the ▼ and ▲ keys.



From here you will be able to access various diagnostic values and measurement monitoring logs.

- Open the menu with the ► key.  
You can now change or view the diagnostic settings.

## 5.9.1 View logbook

The last 6 events for the switching output being logged can be viewed here and all entries deleted:

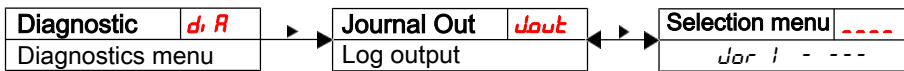

The journal entries will be displayed as:

- Most recent event *Jor 1* occurred x hours (h) / days (d) ago,
- Events 2 to 5 occurred x hours / days ago,
- The oldest event *Jor 6* occurred x hours / days ago,
- Delete function (---)

### Example:

*Jor 1* ⇔ 1.3h, key ▼  
*Jor 2* ⇔ 2.4h, key ▼, ▲  
*Jor 3* ⇔ 6.1h, key ▼, ▲  
*Jor 4* ⇔ 8.2h, key ▼, ▲  
*Jor 5* ⇔ non 8, key ▼, ▲  
*Jor 6* ⇔ non 8, key ▼, ▲  
 ---, key ▲; ► = delete

\*not yet populated, only 4 events have occurred



The information displayed will alternate between the index and time for entry x, e.g. *Jor 1* ⇔ 1.4h for the most recent event 1.4 hours ago.

Press the ► key to return to the submenu or use ▼, ▲ to select the next journal entry.



Confirming the information with the ► key will delete the list of events and return to the submenu.

### Note:

- If no events have been logged, the display will alternate between *Jor X* and *non*.

## 5.9.2 Maximum and minimum temperature

Used to view or delete the saved maximum and minimum temperature:



The journal entries will be displayed as:

- Maximum temperature,
- occurred x hours / days ago,
- Minimum temperature,
- occurred x hours / days ago,
- Delete function

### Example:

7.2 ℃, key ▼  
 8.4h, key ▼, ▲  
 2.2 ℃, key ▼, ▲  
 2.1h, key ▼, ▲  
 ---, key ▲; ► = delete

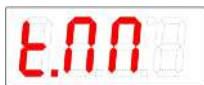

Press the ► key to return to the submenu or use ▼, ▲ to select the next Journal entry.



Confirming the information with the ► key will delete the list of events and return to the submenu.

Menu order:  
 Max. value,  
 time  
 min. value  
 time  
 delete (reset)

### 5.9.3 Define switching output to log

Used to select the switching output to be logged. Only one switching output can be logged.

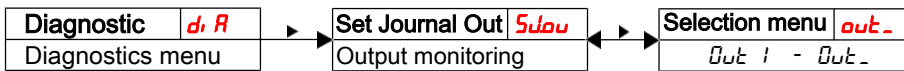

Switching output logging.

Options:

out 1 to outX

#### NOTICE



Values are backed up from volatile to non-volatile memory approx. every three hours.

### 5.9.4 Delay for storing the Min/Max Temperature

A delay time for saving the minimum and maximum temperature can be set to record reliable values when temperatures fluctuate. Here, enter the time span in seconds during which the signal must be continuously present before the temperature is logged.

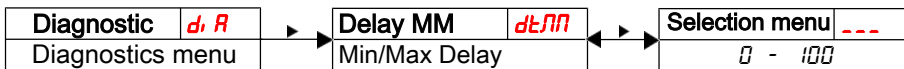

- Use the ▶ key to open the list of values.
- Set the value with the ▼ and ▲ keys and use the ▶ key to confirm (e.g. 5 (seconds)). The device will return to the submenu.

Setting range:  
0...100 seconds

## 6 Cleaning and Maintenance

This device is maintenance-free.

The method for cleaning the devices must be adapted to the IP protection class of the devices. Do not use cleaners which could damage the device materials.

### For versions with filter:

The filter element must be replaced as needed, at least 1x annually. In exceptional cases a small amount of oil can be added via the filter.

During maintenance, remember:

- The equipment must be maintained by a professional familiar with the safety requirements and risks.
- Only perform maintenance work described in these operating and installation instructions.
- When performing maintenance of any type, observe the respective safety and operation regulations.

### 6.1 Replacing the filter element

Replace the filter element as follows:

- Temporarily shut down the system.
- The filter cover counter-clockwise to open.
- Remove the filter element and dispose according to legal regulations.
- Insert the new filter element. Be sure to use the correct filter fineness!
- Screw on the filter cover.
- For filters with optical contamination indicator: Set the display to zero.

#### Hydac filter

When the maximum display value is reached, the red indicator piston will lock in place, indicating the filter service is required. Press the yellow Reset button to reset the display to zero.



#### Filtration Group filter

Filter contamination is indicated in percent (50%, 75% and 100 %). To reset the display to zero, turn the knob in the direction of the arrow until the red part of the indicator disc is turned all the way back.

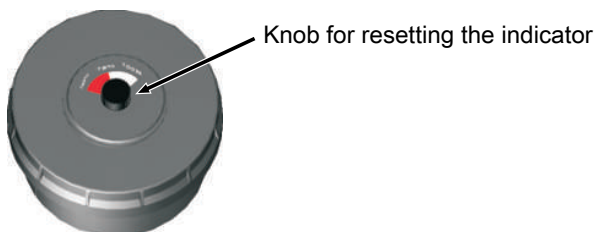

### 6.2 Adding small amounts of oil

#### Nivovent type with BFA or SSR option only:

- Temporarily shut down the system.
- The filter cover counter-clockwise to open.
- Remove the filter element.
- Slowly add oil through the nodular holes.
- Reinsert the filter element and close the cover.
- Restart the system.

## 7 Service and repair

This chapter contains information on troubleshooting and correction should an error occur during operation.

Repairs to the unit must be performed by Bühler authorised personnel.

Please contact our Service Department with any questions:

**Tel.: +49-(0)2102-498955** or your agent

If the equipment is not functioning properly after correcting any malfunctions and switching on the power, it must be inspected by the manufacturer. Please send the equipment inside suitable packaging to:

**Bühler Technologies GmbH**

**- Reparatur/Service -**

**Harkortstraße 29**

**40880 Ratingen**







**Germany**

Please also attach the completed and signed RMA decontamination statement to the packaging. We will otherwise be unable to process your repair order.

You will find the form in the appendix of these instructions, or simply request it by e-mail:

**service@buehler-technologies.com.**

### 7.1 Troubleshooting

Problem / Malfunction	Possible cause	Action
No display	– No supply voltage	– Check cable and replace, if necessary
Error messages on the display:		
Alternating between Err and Exxx: e.g.		
 Error 001	– Ambient temperature too low	– Maintain limits
 Error 002	– Ambient temperature too high	– Maintain limits
 Error 004	– Pt100 defective (short-circuit)	– Send device in for repair
 Error 008	– Pt100 defective (cable break)	– Send device in for repair
 Error 1024	– Internal error	– Please contact customer service

#### Possible errors

Problem / Malfunction	Possible cause	Action
Switching output not triggering when exceeding limits	– Switching output configured incorrectly	– In submenu <b>LoUX</b> : “Test Switching Output” to ensure normal mode
	– Switching output defect	– In submenu <b>LoUX</b> : “Test Switching Output” to test the desired switching output
Switching output constantly switching	– Switching output configured incorrectly	– In submenu <b>LoUX</b> : “Test Switching Output” to ensure normal mode
	– Switching output defect	– In submenu <b>LoUX</b> : “Test Switching Output” to test the desired switching output
The analogue doesn't receive the full/correct output current	– Wrong signal type set	– In submenu <b>RoUX</b> : Check and if necessary set the correct signal type (current/voltage output)
	– Load too high (current output)	– Reduce load to permissible value
Analogue output doesn't change the output signal when the input signal changes	– Analogue output configured incorrectly	– In submenu <b>LoUX</b> : „Test Analogue Output“ to ensure normal mode

## 7.2 Spare parts and accessories

### Accessories

Item no. 4-pin	Item no. 8-pin	Description
9144 05 0010	9144 05 0048	Connecting cable M12x1, 1.5 m, angular coupling and straight plug
9144 05 0046	9144 05 0049	Connecting cable M12x1, 3.0 m, angular coupling and straight plug
9144 05 0047	9144 05 0033	Connecting cable M12x1, 5.0 m, angular coupling and strands



1800-OILSOL  
1800-645765

<https://oilsolutions.com.au/>

[sales@oilsolutions.com.au](mailto:sales@oilsolutions.com.au)

## 8 Disposal

Dispose of parts so as not to endanger the health or environment. Follow the laws in the country of use for disposing of electronic components and devices during disposal.



1800-OILSOL  
1800-645765

<https://oilsolutions.com.au/>

[sales@oilsolutions.com.au](mailto:sales@oilsolutions.com.au)

## 9 Appendices

### 9.1 Technical Data NT 61D

#### Basic Unit

Version	MS	VA
Operating pressure	max. 1 bar	max. 1 bar
Operating temperature	-20 °C to +80 °C	-20 °C to +80 °C
Float	SK 610	SK 221
Min. fluid density	0.80 kg/dm <sup>3</sup>	0.85 kg/dm <sup>3</sup>
Lengths (all versions)	280, 370, 500 mm (Standard) variable to max. 1500 mm	

Material/Version	MS	VA
Display housing	PA	PA
Float	rigid PU	1.4571
Immersion tube	Brass	1.4571
Flange (DIN 24557)	PA	PA
Weight at L=280 mm	approx. 200 g	approx. 300 g
Each 100 mm add	approx. 30 g	approx. 50 g

Level switching output	K10
Max. number	2
Function	NO/NC*
Voltage max.	30 V DC
Switching current max.	0.5 A
Contact load max.	10 VA
Min. contact spacing	40 mm
*NO = falling NC contact / NC = falling NO contact	

#### Temperature display electronics

Display	4 character 7 segment LED
Operation	Via 3 keys
Memory	Min. / Max. Data memory
Starting current input	approx. 100 mA for 100 ms
Current input during operation	approx. 50 mA (without current- and switching outputs)
Supply voltage (U <sub>B</sub> )	10 – 30 V DC (nominal voltage 24 V DC)
Ambient temperature	-20 °C to +70 °C
Display units	Temperature °C / °F
Display range	-20 °C to +120 °C
Alarm setting range	0 °C to 100 °C
Display accuracy	± 1 % from end value
Temperature sensor	<b>Pt 100</b> Class B, DIN EN 60 751 Tolerance ±0.8 °C

#### Includes

Mounting screws (quantity 6), rubberised cork seal

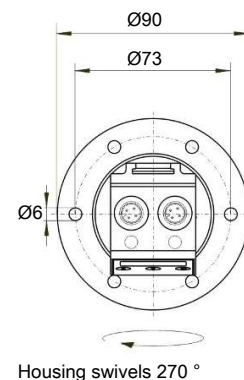
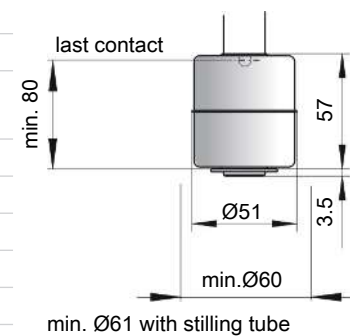
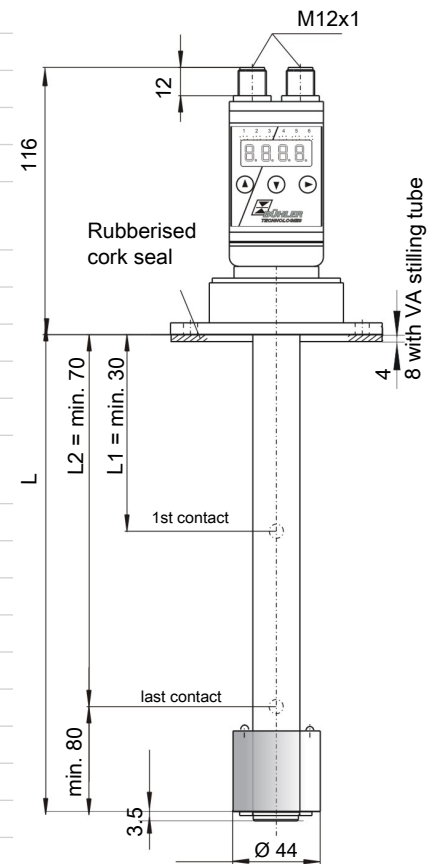



Alternative temperature outputs	-2T	-1T-KT	-4T
Plug (base)	2 x M12 – 4-pin	2 x M12 – 4-pin	1 x M12 – 4-pin 1 x M12 – 8-pin
<b>Switching outputs</b>	2 x freely programmable*	1 x freely programmable*	4 x freely programmable
Alarm memory		with 1 x assignable to alarm logbook	with 1 x assignable to alarm logbook
max. switching current**	0.5 A per output continuous short-circuit protected	0.5 A per output continuous short-circuit protected	0.5 A per output continuous short-circuit protected
Contact load	max. 1 A total	max. 1 A total	max. 1 A total
Analogue output		1 x 4 – 20 mA 2-10 V DC, 0-10 V DC, 0-5 V DC	
Max. burden $\Omega$ as current output		$= (U_B - 8 \text{ V}) / 0.02 \text{ A}$	
Min. input load as voltage output		10 k $\Omega$	
<b>Options:</b> Stilling tube SSR (same material as immersion tube)			

\*also programmable as frequency output

\*\*Output 1 max. 0.2 A.

## 9.2 Technical Data NV 71D

### Basic unit

Version	MS	VA
Operating pressure	max. 1 bar	max. 1 bar
Operating temperature	-20 °C to +80 °C	-20 °C to +80 °C
Float	SK 610	SK 221
Min. fluid density	0.80 kg/dm <sup>3</sup>	0.85 kg/dm <sup>3</sup>
Lengths (all versions)	280, 370, 500 (Standard), variable to max. 1500	

### Material/Version

Display housing	PA	PA
Float	rigid PU (SK 601)	1.4571 (SK 221)
Immersion tube	Brass	1.4571
Flange (DIN 24557)	PA	PA
Weight at L=280 mm	approx. 825 g	approx. 910 g
Each 100 mm add	approx. 30 g	approx. 50 g
Degree of protection	IP65	IP65

### Includes:

Mounting screws (quantity 6) and rubberised cork seal

### Options

Stilling tube (SSR)	Brass	VA
---------------------	-------	----

### Vent filter

#### All versions HY type Hydac BF 7

Filter fineness	3 µm
Additional equipment	Filler cap – n/a with filling adapter

### Temperature display electronics

Display	4 character 7 segment LED
Operation	Via 3 keys
Memory	Min. / Max. Data memory
Starting current input	approx. 100 mA for 100 ms
Current input during operation	approx. 50 mA (without current- and switching outputs)
Supply voltage (U <sub>b</sub> )	10 – 30 V DC (nominal voltage 24 V DC)
Ambient temperature	-20 °C to +70 °C
Display units	Temperature °C / °F
Display range	-20 °C to +120 °C
Alarm setting range	0 °C to 100 °C
Display accuracy	± 1 % from end value

### Temperature sensor

Pt 100 Class B, DIN EN 60751  
Resolution 0.5 °C

### Level switching output

#### K10

Max. number	2
Function	NC / NC*
Function	NC / NC*
Switching current max.	0.5 A
Contact load max.	10 VA
Min. contact spacing	40 mm

\*NO= falling NC contact / NC = falling NO contact

## Temperature outputs

Choose from the following temperature outputs

	-2T	-1T-KT	-4T
Plug (base)	2 x M12 – 4-pin	2 x M12 – 4-pin	1 x M12 – 4-pin 1 x M12 – 8-pin
<b>Switching outputs</b>	2 x freely programmable*	1 x freely programmable*	4 x freely programmable
Alarm memory		with 1 x assignable to alarm logbook	with 1 x assignable to alarm logbook
max. switching current**	0.5 A per output continuous short-circuit protected	0.5 A per output continuous short-circuit protected	0.5 A per output continuous short-circuit protected
Contact load	max. 1 A total	max. 1 A total	max. 1 A total
Analogue output		Analogue output	
Max. burden $\Omega$ as current output		$= (U_B - 8 \text{ V}) / 0.02 \text{ A}$	
Min. input load as voltage output		10 k $\Omega$	

\*also programmable as frequency output

\*\*Output 1 max. 0.2 A.

### 9.3 Dimensions NV 71D

Basic version

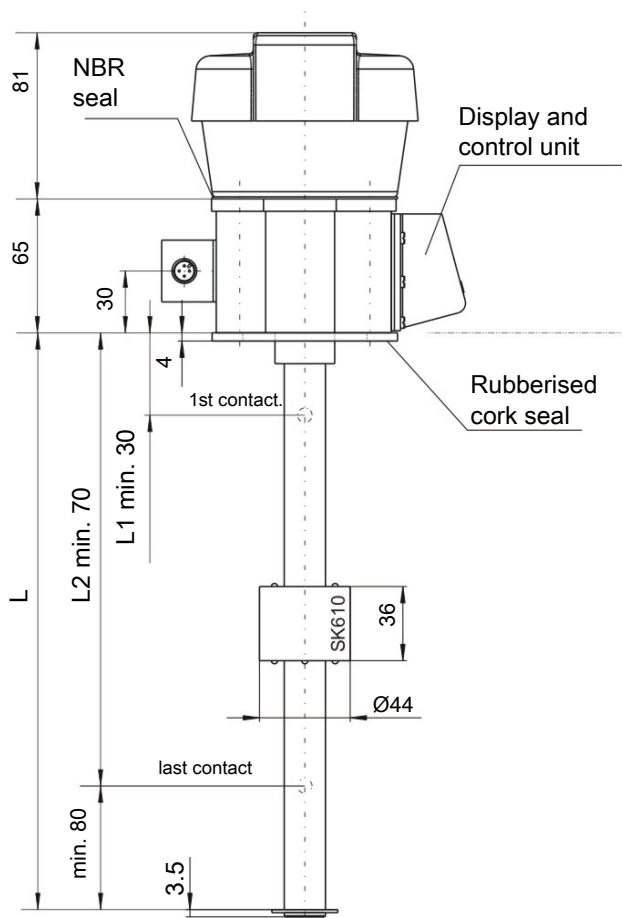

With options

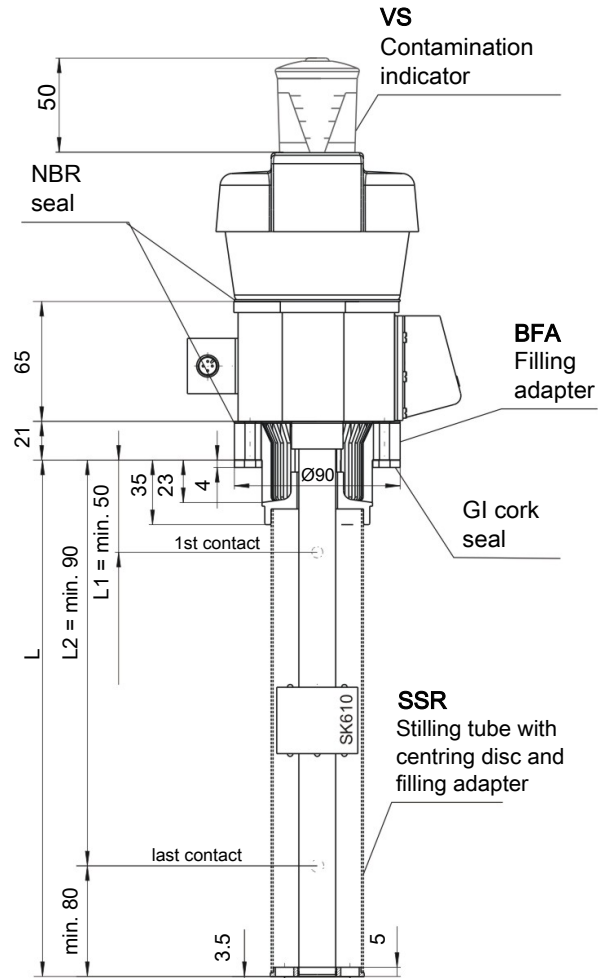

Flange drawing

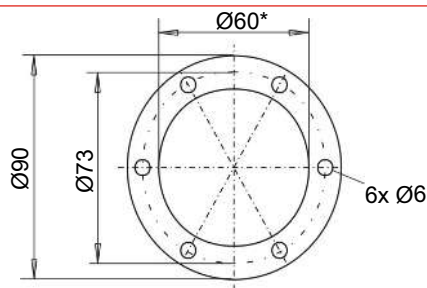

\*min. Ø61 for VA version with stilling tube

Float for NV 71D-VA

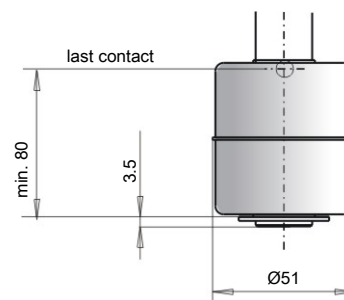

## 9.4 Standard pin assignment NT 61D

### Plug connection

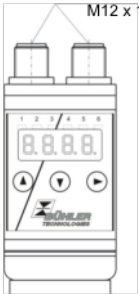
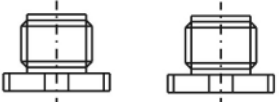
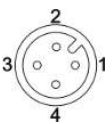
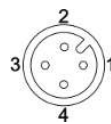
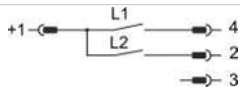
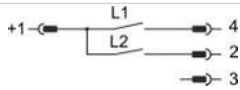
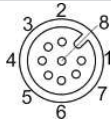
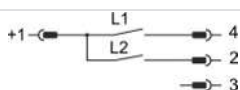
	2 x M12 (base)	
Dimensions		
Number of pins	4-pin / 4-pin	
DIN EN	61076-2-101	
Voltage max.	30 V DC	
		
Connection schematic	<p>Plug A (level)</p> 	<p>Plug B (temperature)</p> 
<b>2T</b>		<b>Pin</b>
2 x temperature output		1 +24 V DC 2 S2 (PNP) 3 GND 4 S1 (PNP)
<b>1T-KT</b>		<b>Pin</b>
1 x Temperature output 1 x Analogue output		1 +24 V DC 2 Analogue 3 GND 4 S1 (PNP)
Connection schematic		
<b>4T</b>		<b>Pin</b>
4 x Temperature output		1 +24 V DC 2 S2 (PNP) 3 GND 4 S1 (PNP) 5 S3 (PNP) 6 S4 (PNP)

## 9.5 Standard pin assignment NV 71D

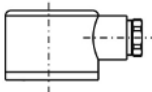
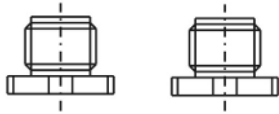
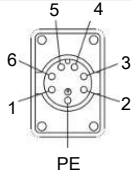
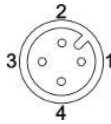
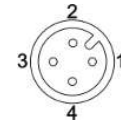
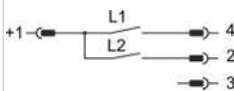
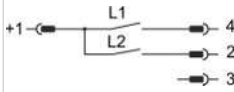
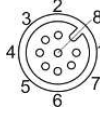
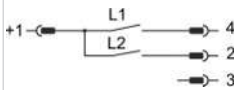
Plug connection	S6	2xM12	
			
Connection schematic		Plug A (level) 	Plug B (temperature) 
<b>2T</b>	<b>Pin</b>		<b>Pin</b>
2 x temperature output	1 +24 V DC 2 2 GND 3 S1 (PNP) 4 S2 (PNP) 5 L1 6 (L2)		1 +24 V DC 2 2 Analogue (out) 3 GND 4 S1 (PNP)
<b>1T-KT</b>	<b>Pin</b>		<b>Pin</b>
1 x temperature output, 1 x analogue output	1 +24 V DC 2 2 GND 3 S1 (PNP) 4 Temp (analogue) 5 L1 6 (L2)		1 +24 V DC 2 2 Analogue (out) 3 GND 4 S1 (PNP)
Connection schematic			
<b>4T</b>			<b>Pin</b>
4 x temperature output			1 +24 V DC 2 S2 (PNP) 3 GND 4 S1 (PNP) 5 S3 (PNP) 6 S4 (PNP)

When measuring the switching output with high-load measuring device inputs or when used as a frequency output, the load must be set to 10 kΩ between the output and earth (GND) to avoid faulty measurements.

## 9.6 Current settings

Switching outputs	Basic Settings	Diagnostics
SP1 / rP1	ou1	5dov
dS1 / dr1 / ou1	Łun1	dŁn1
SP2 / rP2	ou2	
dS2 / dr2 / ou2	Ło	
SP3 / rP3	rou1	
dS3 / dr3 / ou3	rou2	
SP4 / rP4	rou3	
dS4 / dr4 / ou4	rou4	
	d15	
	Łoc	
<b>Analogue outputs</b>	Łc1*	
R1Ł1 / R1Ło / Rou1	ŁcŁ*	
R2Ł1 / R2Ło / Rou2		

\*for wall-mounting only

Date: \_\_\_\_\_

Signature: \_\_\_\_\_

## 9.7 Display ranges

Name	Menu/Unit	Display	Range from/ with unit	Range to/ with unit
<b>Temperature</b>				
°C	Ł	Ł	-100 °C	999 °C
°F	F	F	-100 °F	999 °F
<b>Without</b>				
none	non	none	-1000	9999
none	non1	none	-100.0	999.9
none	non2	none	-10.00	99.99

## 9.8 Display resolution

Range x = |Max - Min|

Range x	Resolution	Range x	Resolution
x < 50	0.1	x < 50	0.1
50 ≤ x < 100	0.2	50 ≤ x < 100	0.2
100 ≤ x < 200	0.5	100 ≤ x < 200	0.5
200 ≤ x < 500	1	200 ≤ x < 500	1
500 ≤ x < 1000	2	500 ≤ x < 1000	2
1000 ≤ x	5	1000 ≤ x	5



1800-OILSOL  
1800-645765

<https://oilsolutions.com.au/>

sales@oilsolutions.com.au

none (*non?*)  
(2 fixed-point numbers)

Range x	Resolution
$x < 5$	0.01
$5 \leq x < 10$	0.02
$10 \leq x < 20$	0.05
$20 \leq x < 50$	0.1
$50 \leq x < 100$	0.2
$100 \leq x$	0.5

**Example** no unit: Min = 100, Max = 1500 ->  $x = 1500 - 100 = 1400$  -> Resolution = 5

**Example** Temperature: Min = 0°C, Max = 100°C ->  $x = 100^\circ\text{C} - 0^\circ\text{C} = 100^\circ\text{C}$  -> Resolution = 0.5°C



1800-OILSOL  
1800-645765

<https://oilsolutions.com.au/>

[sales@oilsolutions.com.au](mailto:sales@oilsolutions.com.au)



### 9.9 Menu Sequence Overview

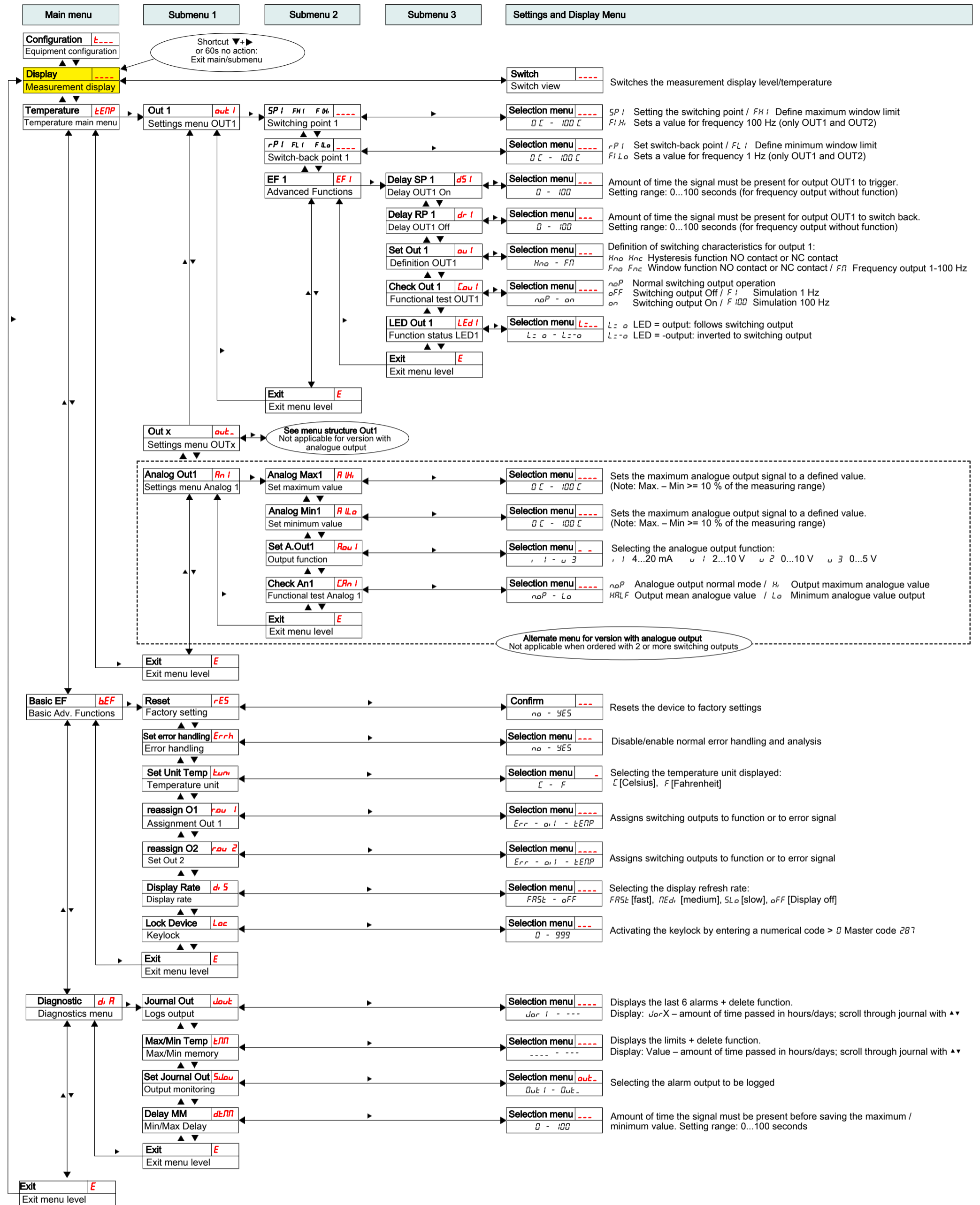

1800-OILSOL  
1800-645765

<https://oilsolutions.com.au/>

[sales@oilsolutions.com.au](mailto:sales@oilsolutions.com.au)

## 10 Attached documents

- Declaration of conformity: KX100020
- RMA - Decontamination Statement



1800-OILSOL  
1800-645765

<https://oilsolutions.com.au/>

[sales@oilsolutions.com.au](mailto:sales@oilsolutions.com.au)

**EU-Konformitätserklärung**  
**EU-declaration of conformity**



Hiermit erklärt Bühler Technologies GmbH,  
dass die nachfolgenden Produkte den  
wesentlichen Anforderungen der Richtlinie

*Herewith declares Bühler Technologies GmbH  
that the following products correspond to the  
essential requirements of Directive*

**2014/30/EU**

**(Elektromagnetische Verträglichkeit / *electromagnetic compatibility*)**

in ihrer aktuellen Fassung entsprechen.

*in its actual version.*

**Produkt / products:** Niveauschalter und –geber / *Level switches and gauges*  
**Typ / type:** Nivotemp 61D, 63, 64, 64D, 67XP, MD, M-XP  
Nivovent 71D, 73, 74, 74D, 77XP

Die Betriebsmittel dienen zur Überwachung des Füllstandes und der Temperatur in Fluidsystemen.  
*The equipment is designed for monitoring level and temperature in fluid systems.*

Das oben beschriebene Produkt der Erklärung erfüllt die einschlägigen  
Harmonisierungsrechtsvorschriften der Union:

*The object of the declaration described above is in conformity with the relevant Union harmonisation  
legislation:*

**EN 61326-1:2013**

Die alleinige Verantwortung für die Ausstellung dieser Konformitätserklärung trägt der Hersteller.  
*This declaration of conformity is issued under the sole responsibility of the manufacturer.*

Dokumentationsverantwortlicher für diese Konformitätserklärung ist Herr Stefan Eschweiler mit  
Anschrift am Firmensitz.

*The person authorised to compile the technical file is Mr. Stefan Eschweiler located at the company's  
address.*

Ratingen, den 20.04.2016

Stefan Eschweiler  
Geschäftsführer – *Managing Director*

Frank Pospiech  
Geschäftsführer – *Managing Director*

KX 10 0020

Bühler Technologies GmbH, Harkortstr. 29, D-40880 Ratingen,  
Tel. +49 (0) 21 02 / 49 89-0, Fax. +49 (0) 21 02 / 49 89-20  
Internet: [www.buehler-technologies.com](http://www.buehler-technologies.com)



1800-OILSOL  
1800-645765

<https://oilsolutions.com.au/>

[sales@oilsolutions.com.au](mailto:sales@oilsolutions.com.au)

# RMA-Formular und Erklärung über Dekontaminierung

## RMA-Form and explanation for decontamination



RMA-Nr./ RMA-No.

Die RMA-Nummer bekommen Sie von Ihrem Ansprechpartner im Vertrieb oder Service./ You may obtain the RMA number from your sales or service representative.

Zu diesem Rücksendeschein gehört eine Dekontaminierungserklärung. Die gesetzlichen Vorschriften schreiben vor, dass Sie uns diese Dekontaminierungserklärung ausgefüllt und unterschrieben zurücksenden müssen. Bitte füllen Sie auch diese im Sinne der Gesundheit unserer Mitarbeiter vollständig aus./ This return form includes a decontamination statement. The law requires you to submit this completed and signed decontamination statement to us. Please complete the entire form, also in the interest of our employee health.

### Firma/ Company

Firma/ Company   
Straße/ Street   
PLZ, Ort/ Zip, City   
Land/ Country

### Ansprechpartner/ Person in charge

Name/ Name   
Abt./ Dept.   
Tel./ Phone   
E-Mail   
Serien-Nr./ Serial No.   
Artikel-Nr./ Item No.

Gerät/ Device   
Anzahl/ Quantity   
Auftragsnr./ Order No.

### Grund der Rücksendung/ Reason for return

- Kalibrierung/ Calibration       Modifikation/ Modification  
 Reklamation/ Claim             Reparatur/ Repair  
 andere/ other

bitte spezifizieren/ please specify

### Ist das Gerät möglicherweise kontaminiert?/ Could the equipment be contaminated?

- Nein, da das Gerät nicht mit gesundheitsgefährdenden Stoffen betrieben wurde./ No, because the device was not operated with hazardous substances.  
 Nein, da das Gerät ordnungsgemäß gereinigt und dekontaminiert wurde./ No, because the device has been properly cleaned and decontaminated.  
 Ja, kontaminiert mit:/ Yes, contaminated with:



explosiv/  
explosive



entzündlich/  
flammable



brandfördernd/  
oxidizing



komprimierte  
Gase/  
compressed  
gases



ätzend/  
caustic



giftig,  
Lebensgefahr/  
poisonous, risk  
of death



gesundheitsge-  
fährdend/  
harmful to  
health



gesund-  
heitsschädlich/  
health hazard



umweltge-  
fährdend/  
environmental  
hazard

### Bitte Sicherheitsdatenblatt beilegen!/ Please enclose safety data sheet!

Das Gerät wurde gespült mit:/ The equipment was purged with:

*Diese Erklärung wurde korrekt und vollständig ausgefüllt und von einer dazu befugten Person unterschrieben. Der Versand der (dekontaminierten) Geräte und Komponenten erfolgt gemäß den gesetzlichen Bestimmungen.*

*This declaration has been filled out correctly and completely, and signed by an authorized person. The dispatch of the (decontaminated) devices and components takes place according to the legal regulations.*

Falls die Ware nicht gereinigt, also kontaminiert bei uns eintrifft, muss die Firma Bühler sich vorbehalten, diese durch einen externen Dienstleister reinigen zu lassen und Ihnen dies in Rechnung zu stellen.

Should the goods not arrive clean, but contaminated, Bühler reserves the right, to commission an external service provider to clean the goods and invoice it to your account.

Firmenstempel/ Company Sign

Datum/ Date

Bühler Technologies GmbH, Harkortstr. 29, D-40880 Ratingen  
Tel. +49 (0) 21 02 / 49 89-0, Fax: +49 (0) 21 02 / 49 89-20  
E-Mail: [service@buehler-technologies.com](mailto:service@buehler-technologies.com)  
Internet: [www.buehler-technologies.com](http://www.buehler-technologies.com)

rechtsverbindliche Unterschrift/ Legally binding signature

DE000011  
01/2019



1800-OILSOL  
1800-645765

<https://oilsolutions.com.au/>

[sales@oilsolutions.com.au](mailto:sales@oilsolutions.com.au)



*Die Analyse defekter Baugruppen ist ein wesentlicher Bestandteil der Qualitätssicherung der Firma Bühler Technologies.*

*Um eine aussagekräftige Analyse zu gewährleisten muss die Ware möglichst unverändert untersucht werden. Es dürfen keine Veränderungen oder weitere Beschädigungen auftreten, die Ursachen verdecken oder eine Analyse unmöglich machen.*

*Bei elektronischen Baugruppen kann es sich um elektrostatisch sensible Baugruppen handeln. Es ist darauf zu achten, diese Baugruppen ESD-gerecht zu behandeln. Nach Möglichkeit sollten die Baugruppen an einem ESD-gerechten Arbeitsplatz getauscht werden. Ist dies nicht möglich sollten ESD-gerechte Maßnahmen beim Austausch getroffen werden. Der Transport darf nur in ESD-gerechten Behältnissen durchgeführt werden. Die Verpackung der Baugruppen muss ESD-konform sein. Verwenden Sie nach Möglichkeit die Verpackung des Ersatzteils oder wählen Sie selber eine ESD-gerechte Verpackung.*

*Beachten Sie beim Einbau des Ersatzteils die gleichen Vorgaben wie oben beschrieben. Achten Sie auf die ordnungsgemäße Montage des Bauteils und aller Komponenten. Versetzen Sie vor der Inbetriebnahme die Verkabelung wieder in den ursprünglichen Zustand. Fragen Sie im Zweifel beim Hersteller nach weiteren Informationen.*

*Analysing defective assemblies is an essential part of quality assurance at Bühler Technologies.*

*To ensure conclusive analysis the goods must be inspected unaltered, if possible. Modifications or other damages which may hide the cause or render it impossible to analyse are prohibited.*

*Electronic assemblies may be sensitive to static electricity. Be sure to handle these assemblies in an ESD-safe manner. Where possible, the assemblies should be replaced in an ESD-safe location. If unable to do so, take ESD-safe precautions when replacing these. Must be transported in ESD-safe containers. The packaging of the assemblies must be ESD-safe. If possible, use the packaging of the spare part or use ESD-safe packaging.*

*Observe the above specifications when installing the spare part. Ensure the part and all components are properly installed. Return the cables to the original state before putting into service. When in doubt, contact the manufacturer for additional information.*



1800-OILSOL  
1800-645765

<https://oilsolutions.com.au/>

[sales@oilsolutions.com.au](mailto:sales@oilsolutions.com.au)

