

Pressure sensors/pressure switches

Pressotronik

Monitoring the oil pressure is essential in hydraulic systems and oil supply systems. It's important to monitor both process-related pressure ranges as well as safety shutdowns, load limits or simply to determine if the lubricating pressure is adequate.

The pressure transmitters must meet a variety of requirements with respect to their pressure resistance, signal output, programmability or the plug connection style. A local or status display is often required for safety reasons

The Pressotronik series spans a wide range of pressure transmitters and programmable pressure switches. They cover a broad pressure range, meet high safety requirements and feature different signal types. The easyMont housings of the remote displays can be grouped for easy and space-saving display groups, making them easier to monitor.

Pressure ratings up to 600 bar

Compact size.

Up to four programmable switching outputs

Alternative analogue output (configurable to current or voltage) plus one, two or four programmable switching outputs

Switching outputs characteristics configurable as window or hysteresis

Two switching outputs configurable as window or hysteresis

Direct or external display and control mounting

Virtually any cable length between measuring point and display

Easy to read LED display with status of switching outputs, 270° pivot when direct mounted

Standard menu structure based on VDMA standard sheet 24574 ff.

Min/max memory, logbook function



Technical Data Pressotronik 700

Pressure transmitter

	Pressure range	Dimensions Pressotronik 700	
	0 - 10 bar 0 - 25 bar 0 - 100 bar 0 - 250 bar 0 - 400 bar 0 - 600 bar		
	Other pressure ranges available upon request		
Pressure connection	G1/4 external thread, DIN 3852 Form E; peak pressure aperture standard for 100 bar and higher		
Overload higher values available upon request	2.5 x full range at 10 to 600 bar (but max. 900 bar)		
Burst pressure Higher burst pressure available upon request	2.5 x full range at 6 to 600 bar (but max. 900 bar) Patented medium stop system to prevent medium leaks when exceeding the bursting pressure range (>40 bar rated pressure)		
Material / version			
Housing	1.4305		
Material in contact with media	Ceramic, 1.4305, PPS, FPM		
Weight	approx. 95 g		
Temperature			
Medium	-15 °C to + 125 °C		
Ambient temperature	max. 85 °C		
Temperature influences	Within - 40 to +125 °C temperature range		
	Calibration in bar	Calibration in psi	
TC0 - Temperature zero error	< ±0.15 % FS/10 K	< ±0.25 % FS/10 K	
TCE - Temperature full range error	< ±0.15 % FS/10 K	< ±0.15 % FS/10 K	
Response time	< 2 ms / typically 1 ms		
Electrical data		Standard pin assignment Pressotronik 700	
Supply voltage (U _B)	10 – 30 V DC (nominal voltage 24 V DC)	Plug: 1xM12x1	
Degree of protection	IP67	Pin	
Burden Ω	= (U _B -8 V) / 0.02 A	1	+24 V DC
Dielectric strength	500 V DC	3	4-20 mA



1800-OILSOL
1800-645765

<https://oilsolutions.com.au/>

sales@oilsolutions.com.au

Accuracy

Parameter	Unit
Tolerance zero	max. ± 0.3 % FS
Tolerance full range	max. ± 0.3 % FS
Resolution	0.1 % FS
Sum of linearity, hysteresis and reproducibility	max. $\pm 0.3\%$ FS/10K
Long-term stability per DIN EN 60770	± 1 % FS
TC zero	max. ± 0.15 % FS/10K
TC sensitivity	max. ± 0.15 % FS/10K

Test conditions: 25 °C, 45 % rF, supply 24 V DC, K0/TCE -40 °C... +125 °C

Ordering instructions Pressotronik 700

Pressotronik 700 - Transmitter only

Item no.	Description	Pressure range
137000100	PT700-010	0 - 10 bar
137000250	PT700-025	0 - 25 bar
137001000	PT700-100	0 - 100 bar
137002500	PT700-250	0 - 250 bar
137004000	PT700-400	0 - 400 bar
137006000	PT700-600	0 - 600 bar

Accessories

Item no.	Description
9144 05 0010	Connecting cable M12x1, 4-pin, 1.5 m, angular coupling and straight plug
9144 05 0046	Connecting cable M12x1, 4-pin, 3.0 m, angular coupling and straight plug
9144 05 0047	Connecting cable M12x1, 4-pin, 5.0 m, angular coupling and strands



1800-OILSOL
1800-645765

<https://oilsolutions.com.au/>

sales@oilsolutions.com.au

Technical Data Pressotronik 770

Remote display version (PT700 pressure transmitter must be ordered separately)

For pressure transmitter	Pressotronik 700
Control unit	
Version	
Housing material	PA
Mount	35 mm top-hat rail mounting
Weight	approx. 400 g
Degree of protection	IP65
Analysis display electronics	
Display	4 character 7 segment LED display
Operation	via 3 keys
Starting current input	approx. 100 mA for 100 ms
Power input during operation	approx. 50 mA
Supply voltage (U _B)	10 - 30 V DC (nominal voltage 24 V DC)
Ambient temperature	-20 °C to +70 °C
Accuracy	± 1 % from end value
Input values	
Display units	b (bar), P (psi), °MPa
Input signal	4-20 mA

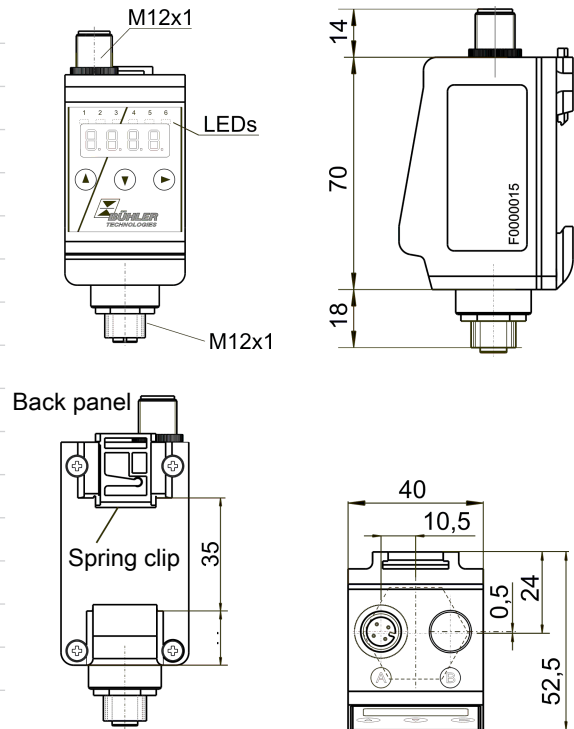

Optional switching outputs

	-1D1S	-2S	-4S	-6S
Plug (base)	1 x M12 – 4-pin	1 x M12 – 4-pin	1 x M12 – 8-pin	1 x M12 – 8-pin
Plug (jack)	1 x M12 – 4-pin	1 x M12 – 4-pin	1 x M12 – 4-pin	1 x M12 – 4-pin
Switching outputs	IO-Link and 1x freely programmable	2 x freely programmable	4 x freely programmable	6 x freely programmable
Alarm memory	with 1 x assignable to alarm logbook	with 1 x assignable to alarm logbook	with 1 x assignable to alarm logbook	with 1 x assignable to alarm logbook
max. switching current	0.5 A per output*	0.5 A per output*	0.5 A per output*	0.5 A per output*
Contact load	max. 1 A total	max. 1 A total	max. 1 A total	max. 1 A total

*Output 1 max. 0.2 A.

	-1S-K	-2S-K	-4S-K
Plug (base)	1 x M12 – 4-pin	1 x M12 – 5-pin	1 x M12 – 8-pin
Plug (jack)	1 x M12 – 4-pin	1 x M12 – 4-pin	1 x M12 – 4-pin
Switching outputs	1 x freely programmable	2 x freely programmable	4 x freely programmable
Alarm memory	with 1 x assignable to alarm logbook	with 1 x assignable to alarm logbook	with 1 x assignable to alarm logbook
max. switching current	0.5 A per output*	0.5 A per output*	0.5 A per output*
Contact load	max. 1 A total	max. 1 A total	max. 1 A total
Analogue outputs	1 x pressure	1 x pressure	1 x pressure
Programmable as	1 x 4 – 20 mA 2 – 10 V DC, 0 – 10 V DC, 0 – 5 V DC	1 x 4 – 20 mA 2 – 10 V DC, 0 – 10 V DC, 0 – 5 V DC	1 x 4 – 20 mA 2 – 10 V DC, 0 – 10 V DC, 0 – 5 V DC
max. load Ω as current output	(U _B – 8V) / 0.02 A	(U _B – 8V) / 0.02 A	(U _B – 8V) / 0.02 A
min. input load as voltage input	10 kΩ	10 kΩ	10 kΩ

*Output 1 max. 0.2 A.

Technical Data Pressotronik 771

Version with attached transmitter

Pressure transmitter	Pressotronik 700
Control unit	Version
Housing material	PA
Mount	G1/4 directly mounted display rotates 270°
Weight	approx. 500 g
Degree of protection	IP65
Display electronics	
Display	4 character 7 segment LED display
Control	via 3 keys
Starting current input	approx. 100 mA for 100 ms
Power input during operation	approx. 50 mA
Supply voltage (U _B)	10 - 30 V DC (nominal voltage 24 V DC)
Ambient temperature	-20 °C to +70 °C
Accuracy	± 1% from full range
Input values	
Display units	b (bar), P (psi), °MPa

Housing swivels 270 °C

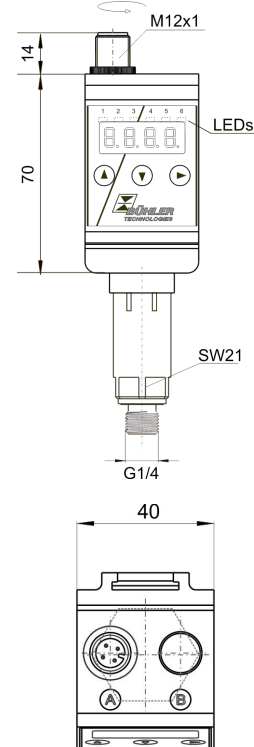

Optional switching outputs	-1D1S	-2S	-4S	-6S
Plug (base)	1 x M12 – 4-pin	1 x M12 – 4-pin	1 x M12 – 8-pin	1 x M12 – 8-pin
Switching outputs	IO-Link and 1x freely programmable	2 x freely programmable*	4 x freely programmable*	6 x freely programmable*
Alarm memory	with 1 x assignable to alarm logbook	with 1 x assignable to alarm logbook	with 1 x assignable to alarm logbook	with 1 x assignable to alarm logbook
max. Switching current	0.5 A per output**	0.5 A per output**	0.5 A per output**	0.5 A per output**
Contact load	max. 1 A total	max. 1 A total	max. 1 A total	max. 1 A total

*also programmable as frequency output.

**Output 1 max. 0.2 A.

	-1S-K	-2S-K	-4S-K
Plug (base)	1 x M12 – 4-pin	1 x M12 – 5-pin	1 x M12 – 8-pin
Switching outputs	1 x freely programmable	2 x freely programmable	4 x freely programmable
Alarm memory	with 1 x assignable to alarm logbook	with 1 x assignable to alarm logbook	with 1 x assignable to alarm logbook
max. Switching current	0.5 A per output*	0.5 A per output*	0.5 A per output*
Contact load	max. 1 A total	max. 1 A total	max. 1 A total
Analogue outputs			
Programmable as	1 x pressure 1 x 4 – 20 mA 2 – 10 V DC, 0 – 10 V DC, 0 – 5 V DC	1 x pressure 1 x 4 – 20 mA 2 – 10 V DC, 0 – 10 V DC, 0 – 5 V DC	1 x pressure 1 x 4 – 20 mA 2 – 10 V DC, 0 – 10 V DC, 0 – 5 V DC
max. load Ω as current output	(U _B – 8V) / 0.02 A	(U _B – 8V) / 0.02 A	(U _B – 8V) / 0.02 A
min. input load as voltage input	10 kΩ	10 kΩ	10 kΩ

*Output 1 max. 0.2 A.



1800-OILSOL
1800-645765

<https://oilsolutions.com.au/>

sales@oilsolutions.com.au

Ordering instructions Pressotronik 770/771

Model key Pressotronik 770/771

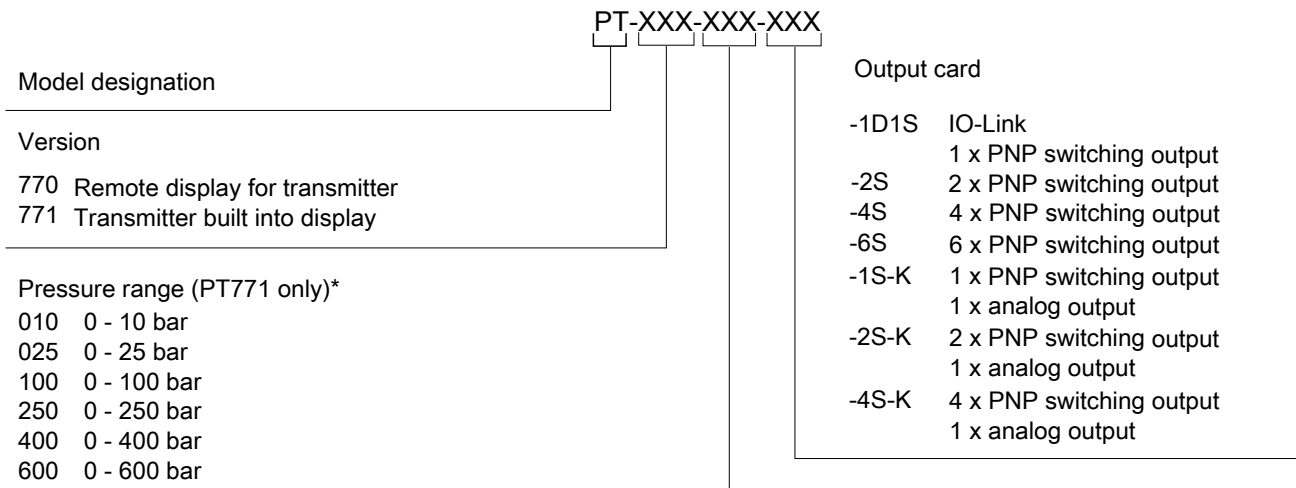

*on PT770 the pressure range can be preset at the factory.

Item no. 4-pin	Item no. 5-pin	Item no. 8-pin	Description
9144 05 0010	9144 05 0016	9144 05 0048	Connecting cable M12x1, 1.5 m, angular coupling and straight plug
9144 05 0046	9144 05 0017	9144 05 0049	Connecting cable M12x1, 3.0 m, angular coupling and straight plug
9144 05 0047	9144 05 0018	9144 05 0033	Connecting cable M12x1, 5.0 m, angular coupling and strands

Ordering example

You require: Pressure transmitter with 400 bar; 4 programmable PNP switching outputs; remote display; 3 m connecting cable

Order: Pressotronik 700 (item no.: 13700 4000)
 Connecting cable (item no.: 9144 05 0046)
 Pressotronik 770 display and controller (item no.: 1377 000)



1800-OILSOL
1800-645765

<https://oilsolutions.com.au/>

sales@oilsolutions.com.au

Standard pin assignment Pressotronic 770

Pin assignment Pressotronic 770

For the pressure transmitter assignment, see **Pressotronic 700 standard pin assignment**

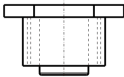
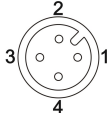
Panel jack	1x M12x1 4-pin
	
Panel jack	
Pin	
1	+24 V DC
3 / 4	4 - 20 mA

Standard pin assignment Pressotronic 770 and 771

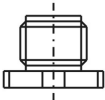
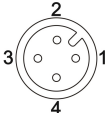
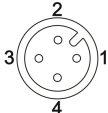
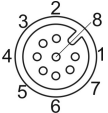
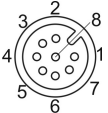
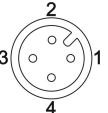
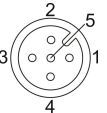
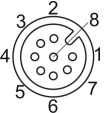
Version	-1D1S	-2S	-4S	-6S	-1S-K	-2S-K	-4S-K
Panel plug	4-pin	4-pin	8-pin	1x M12x1 8-pin	4-pin	5-pin	8-pin
							
Panel plug							
Pin							
1	+24 V DC	+24 V DC	+24 V DC	+24 V DC	+24 V DC	+24 V DC	+24 V DC
2	S2 (PNP)	S2 (PNP)	S2 (PNP)	S2 (PNP)	Analogue (out)	S2 (PNP)	S2 (PNP)
3	GND	GND	GND	GND	GND	GND	GND
4	C/Q (IO-Link)	S1 (PNP)	S1 (PNP)	S1 (PNP)	S1 (PNP)	S1 (PNP)	S1 (PNP)
5			S3 (PNP)	S3 (PNP)		Analogue (out)	S3 (PNP)
6			S4 (PNP)	S4 (PNP)			S4 (PNP)
7				S5 (PNP)			Analogue (out)
8				S6 (PNP)			