

# Cylinders & servocylinders

Industrial, Ex-proof and Stainless Steel Cylinders designed according to international standards with rugged design and extended operative life



OIL SOLUTIONS

PO Box 38  
Strathfieldsaye, VIC, 3551  
1800 OIL SOL  
1800 645 765

[sales@oilsolutions.com.au](mailto:sales@oilsolutions.com.au)

[www.oilsolutions.com.au](http://www.oilsolutions.com.au)

"For All Your Hydraulic Needs"

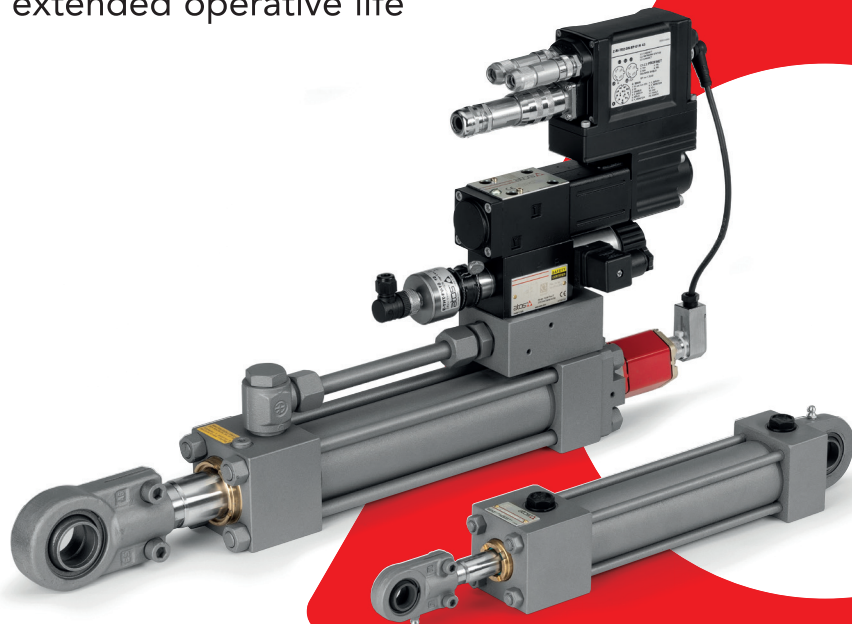

**atos**   
the **smart** electrohydraulics

# Industrial cylinders

Standard range of ISO cylinders with square or round heads, tie-rods or counter flanges, multiple mounting styles, low friction seals for high precision motion control. Strokes up to 5.000 mm

## Sectors

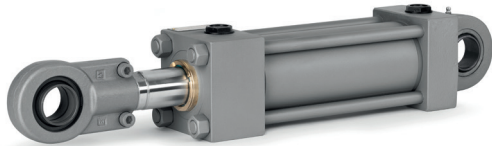

**CK**  
ISO 6020-2

 Bore  $\varnothing$  25 ÷ 200 mm  
Pmax 250 bar

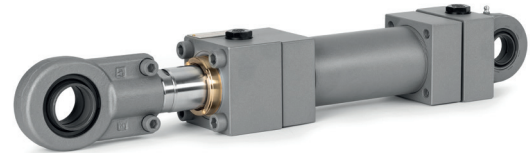

**CH**  
ISO 6020-2/3

 Bore  $\varnothing$  63 ÷ 400 mm  
Pmax 250 bar



**CN**  
ISO 6020-1

 Bore  $\varnothing$  40 ÷ 200 mm  
Pmax 250 bar



**CC**  
ISO 6022

 Bore  $\varnothing$  50 ÷ 320 mm  
Pmax 320 bar

## Ex-proof cylinders



Certified for hazardous environments ATEX gas II 2G, dust II 2D. Square heads with tie-rods, low friction seals

### Sectors



Energy



Oli & gas



Mining

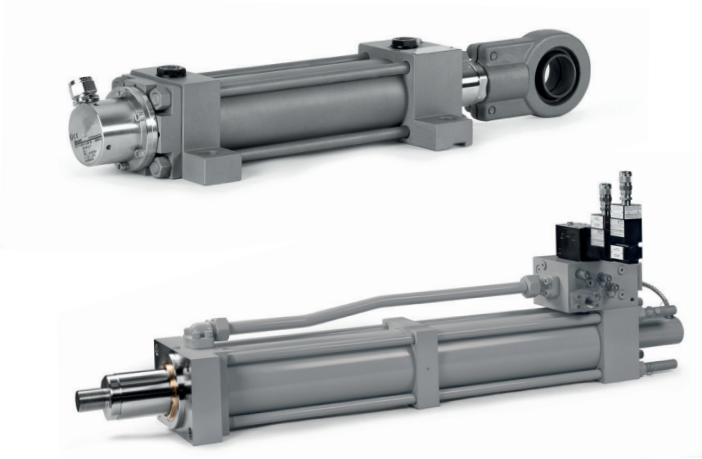

## CKA

ISO 6020-2



Bore  $\varnothing$  25 ÷ 200 mm

Pmax 250 bar

## Stainless steel cylinders



Full stainless steel to provide the highest resistance to corrosive environments and fluids. Round heads with counterflanges, low friction seals

### Sectors



Marine



Chemical



Food

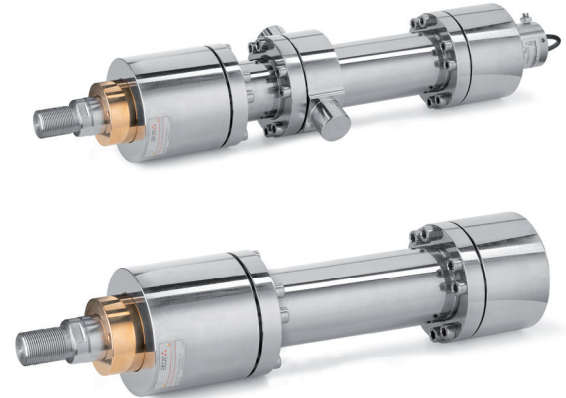

## CNX

ISO 6020-1



Bore  $\varnothing$  50 ÷ 100 mm

Pmax 150 bar

## Servocylinders



High performance cylinders equipped with built-in position transducer. Low friction seals ensure full motion control during positioning, while the rugged design grant an high degree of reliability



Servocylinders are fully compliant to ISO standards, since the transducer installation does not affect the fixing dimensions



Servocylinders for high temperatures allow to remote the conditioning electronics outside the hot zone

## Servoactuators



Smart and compact units that integrate servocylinders and axis control valves, to fully manage the motion cycle

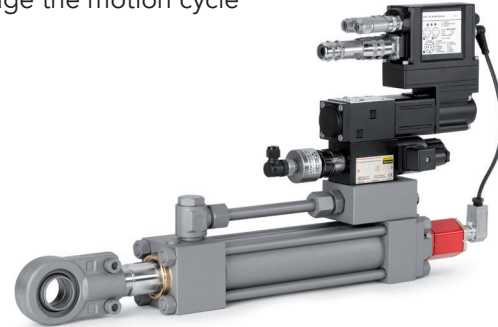





Industrial servoactuator with on-board axis control and built-in transducer



Ex-proof ATEX servoactuator with on-board axis control and built-in transducer

## Position transducers

Extended operative life position transducers with analog, SSI, fieldbus or IO-link outputs. Programmable settings for stroke, resolution and data format

Servocylinder	Type	Output	Linearity [% F.S.]	Repeatability [% F.S.]	Max speed [m/s]	Stroke [mm]	Temperature [°C]
<b>CKM</b> 	Magnetosonic, programmable, contactless	SSI, fieldbus, analog	$< \pm 0,01\%$	$< \pm 0,001\%$	2	25 ÷ 3.000	-20°C ÷ 75°C
<b>CKF</b> 	Magnetosonic, contactless	SSI, IO-link, analog	$< \pm 0,02\%$	$< \pm 0,005\%$	1	50 ÷ 2.500	-20°C ÷ 75°C
<b>CKN</b> 	Magnetostrictive, programmable, contactless	analog	$< \pm 0,02\%$	$< \pm 0,005\%$	1	100 ÷ 3.000	-20°C ÷ 90°C
<b>CKP</b> 	Potentiometric, sliding contact	analog	$< \pm 0,1\%$	$\pm 0,01\%$	0,5	100 ÷ 700	-20°C ÷ 100°C
<b>CKV</b> 	Inductive, contactless	analog	$< \pm 0,2\%$	$\pm 0,05\%$	1	30 ÷ 1.000	-20°C ÷ 120°C

## Proximity sensors

Proximity sensors detect the rod position when the piston enters in the influence area of the magnetic field generated by the sensor

**Fixed inductive sensors** to detect the rod position at the mechanical end stroke. Available for ex-proof cylinders with ATEX certification EX II 3G T4 X



**CK**

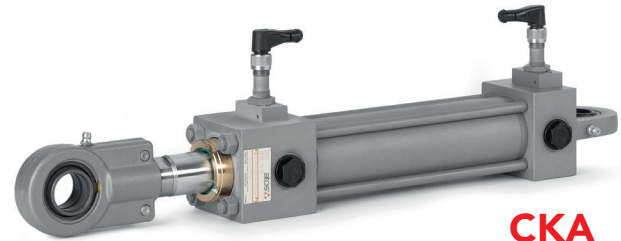

**CKA**

**Adjustable Reed or Hall effect sensors** installed on the tie-rods and positioned along the cylinder stroke. Available for ex-proof cylinders with ATEX certification EX II 1 GD T4 and separate amplifier

### Reed

- High switching power
- 2 wire circuit for easy connection
- Max current: 500 mA

### Hall effect

- Contactless electronic sensor
- Non-wearing parts
- High sensitivity and reliability
- Max current: 250 mA



**CKS**  
ISO 6020-2



Bore  $\varnothing$  25 ÷ 100 mm

Pmax 150 bar

## Safety standards and options

Atos cylinders and servocylinders successfully fulfil the highest safety requirements

### Cylinders construction method

SC3 certification up to SIL3, achieved due to excellent design procedures and production processes, aimed at ensuring the highest level of quality and preventing the systematic failures



### Position transducers

Magnetostrictive or magnetosonic, certified IEC 61508 up to SIL2. Optional redundancy of transducer measurement stage with single output or with multiple output signals

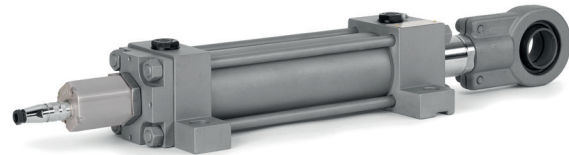

### Rod locking systems

Bi-directional units, with optional inductive sensors, used as functional clamps for precision locking or to prevent undesired rod movement, according to ISO 16092 for machine tools safety



# High performance hydraulic cushionings

Cushionings' profiles are designed to reduce the cylinder speed before the rod contacts the mechanical end stroke, dissipating the energy with limited pressure spikes

**Fast version:** speed up to 1 m/s

**Slow version:** speed 0,05 ÷ 0,5 m/s

**Adjustable version:** allows cushioning optimization according to rod speed

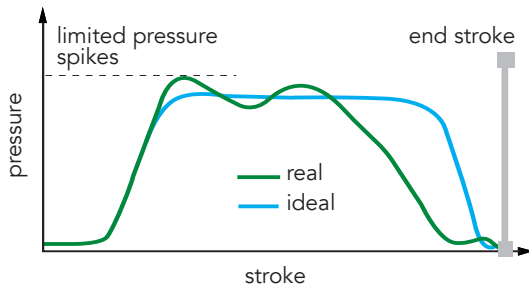
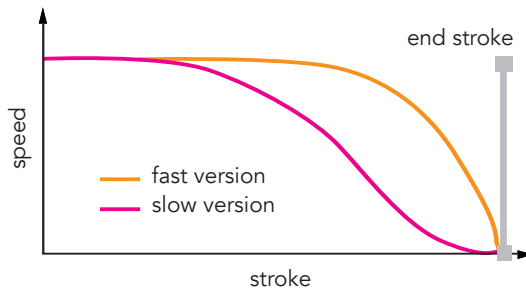

Outflow velocity

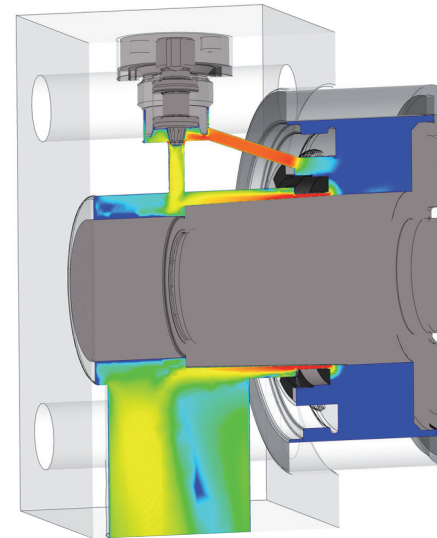
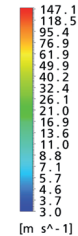

## Special applications

Atos cylinders and servocylinders can be customized to suit any special application and fulfill the critical requirements of the most demanding sectors

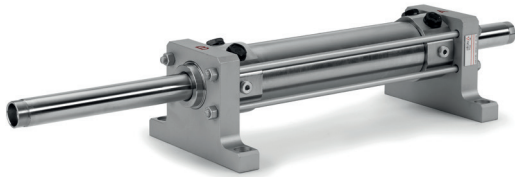

Safety block for railway switches



Military vehicles stabilizer

Our experience allows to quickly provide a wide range of solutions with special steels and treatments to avoid premature corrosion or wear, ensuring performance and reliability in heavy duty applications. As well as position transducers suitable for extreme temperatures, up to 200°C or -40°C

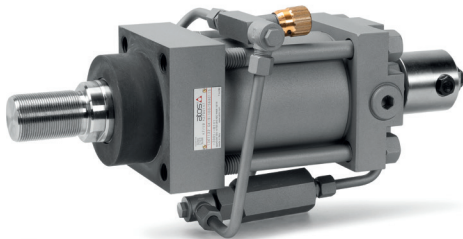

Coils decoiler safety block



Railway cross switching

# Materials

## Tie-rods

Normalized steel with rolled threads to enhance strength

## Piston

Carbon steel, preloaded and mechanically locked on the rod

## Rod

Hardened and tempered alloy steel, with rolled threads

## Chrome plating

Corrosion resistance up to 200h in NSS.  
Thickness 20  $\mu\text{m}$   
Hardness  $\sim 1.000$  HV

## Rod bearing

Bronze bearings or guide rings for heavy radial loads

## Body

Cold drawn or hot rolled, according to the cylinder size.  
The design and materials grant a factor 4 safety level

## Heads and trunnions

Cast iron or steel, tested by ultrasonic analysis

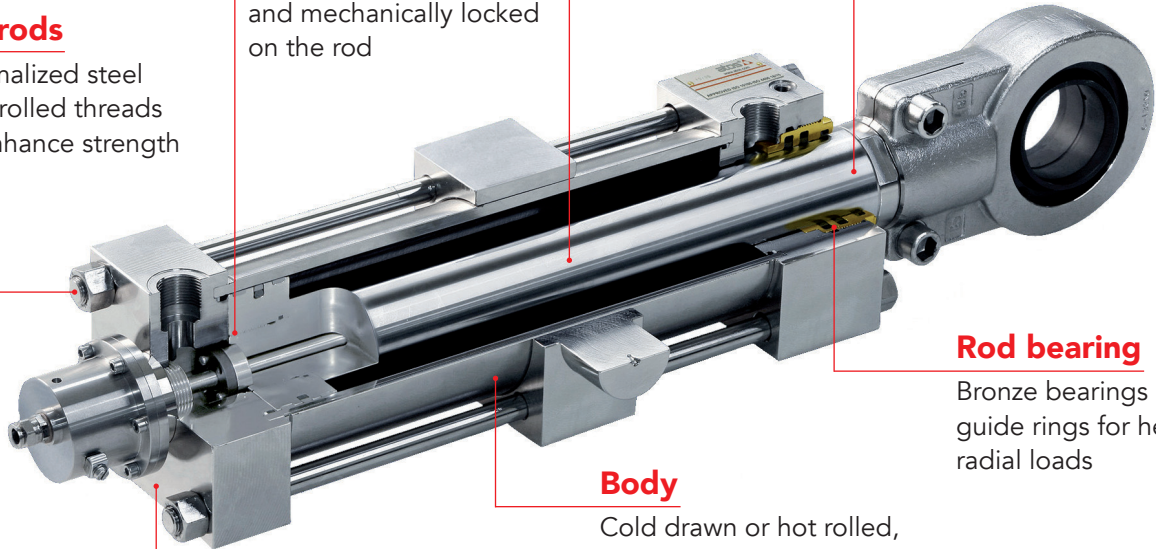

## Anticorrosion coatings

For aggressive environments such as off-shore, chemical, railways, naval and military sectors



### Nichel - Chrome rod

Corrosion resistance up to 1.000h in NSS, rating 10  
Thickness 50  $\mu\text{m}$  (30  $\mu\text{m}$  Ni + 20  $\mu\text{m}$  Cr)  
Hardness ~1.000 HV



### Ceramic rod

Corrosion resistance up to 5.000h in NSS, rating 10  
Thickness 500  $\mu\text{m}$   
Hardness ~1.000 HV

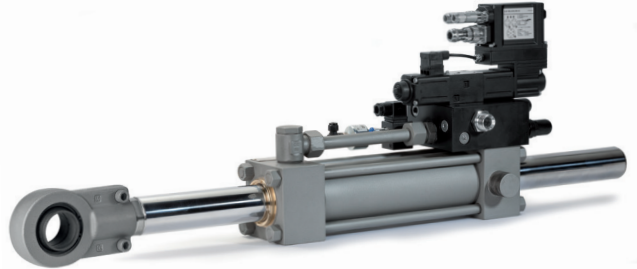

### HVOF or plasma rod

Corrosion resistance up to 2.000h in NSS, rating 10  
Thickness 200  $\mu\text{m}$   
Hardness ~1.300 HV

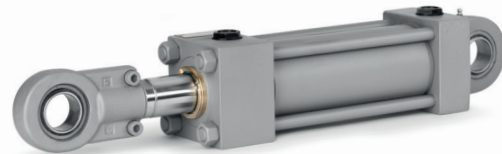

### Geomet heads & body

Corrosion resistance >1.000h in NSS, rating 10  
Thickness 8 ÷ 10  $\mu\text{m}$

## Sealing systems

The Atos wide range of sealing systems meets the requirements of extended temperature range, high work speeds and several hydraulic fluids

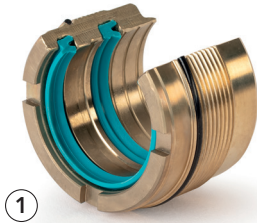

① Bronze bearings with **polyurethane + NBR** seals, high sealing and vibration damping capabilities

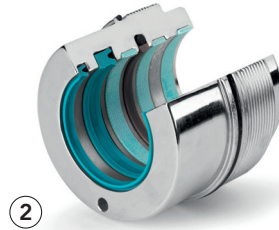

② Steel bearings with **polyurethane + PTFE** seals, high sealing capability for heavy duty applications. Pmax 320 bar

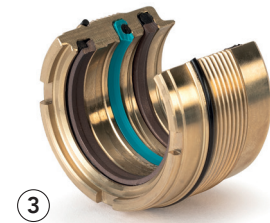

③ Bronze bearings with **special polymers** compounds seals for critical applications with temperature up to 200°C or -40°C

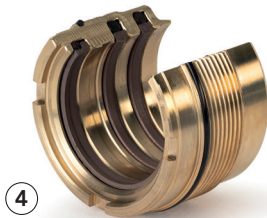

④ Bronze bearings with **PTFE + NBR or mineral fiber** seals, low friction / wear at high working frequencies, up to 15 Hz

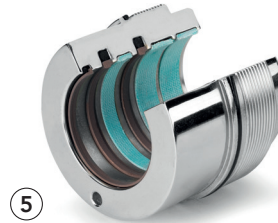

⑤ Steel bearings with **PTFE + FKM** seals with very low friction and extended guiding system for radial loads

N°	Materials	Speed [m/s]	Fluids	Fluid temperature	Main features	Group
①	Polyurethane + NBR	0,5	Mineral oil	-20°C ÷ 85°C	High static and dynamic sealing	Ⓐ
②	Polyurethane + PTFE	0,5	Mineral oil	-20°C ÷ 85°C	High static and dynamic sealing, low friction	Ⓑ
③	Special polymers	1	Mineral oil, synthetic or water based fire-proof fluids	-40°C ÷ 85°C	Very high sealing, low wear, anti stick slip, low temperature	Ⓒ
		4	Skydrol, Dot	-20°C ÷ 200°C	Very low friction, very high temperature	
④	PTFE + NBR	4	Mineral oil, synthetic or water based fire-proof fluids	-20°C ÷ 85°C	Very low friction	Ⓒ
	PTFE + mineral fiber	> 4	Mineral oil, synthetic or water based fire-proof fluids	-20°C ÷ 120°C	Very low friction, high working frequency, low wear	
⑤	PTFE + FKM	4	Mineral oil, synthetic or water based fire-proof fluids	-20°C ÷ 120°C	Very low friction, high temperature	Ⓒ

Polyurethane material ensures high hydraulic sealing, PTFE suits high speeds with very low friction forces, while special polymers grant performance and low wear in critical applications

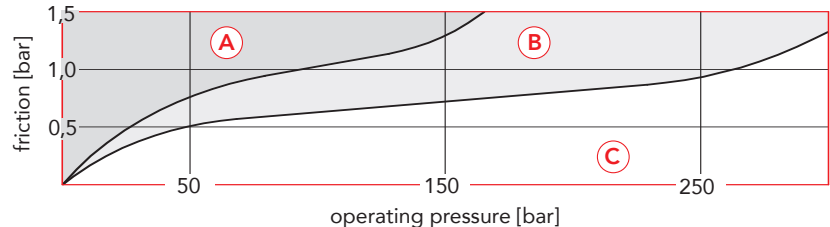

# Research & Development

We believe in the value of technology and we are constantly searching for innovation and quality, through laboratory research, CFD/FEM analysis, simulations of extreme environments or special applications operating conditions

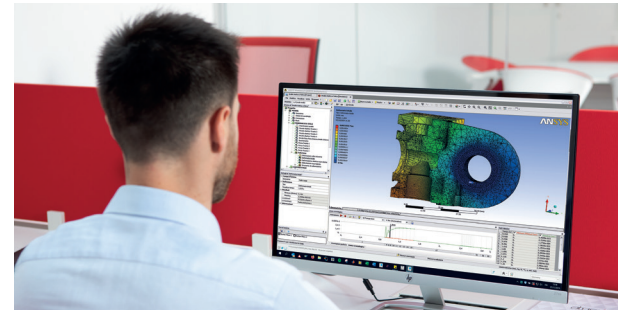

## CFD - Computational Fluid Dynamics

We use fluidodynamic simulation software to design the best hydraulic solutions according to performance requirements

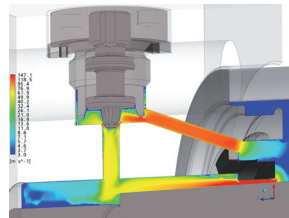
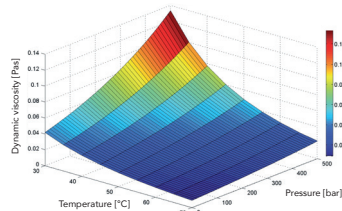
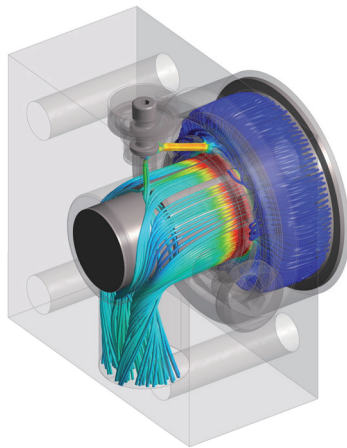

## FEM - Finite Element Method

We perform accurate mechanical stress analysis of each part, such as heads, tie rods and threads, thus estimating the operative working life of the cylinder in relationship to applied load

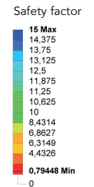
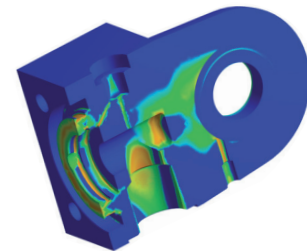
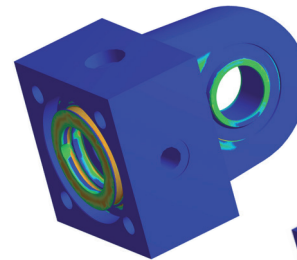

# Atos Cylinders Division



30.000 cylinders/year



6.000 m<sup>2</sup> plants



40 employees





1800-OILSOL  
1800-645765

<https://oilsolutions.com.au/>

sales@oilsolutions.com.au



## Worldwide Sales Organization

A sales network with 25 branches, 120 sales professionals and distributors in more than 80 countries, together with great responsiveness and focus on customers



Atos spa

Cylinders Division

Italy - 41122 Modena

phone +39 059 250550

infocylinder@atos.com - www.atos.com