

# **Repair Instructions**

## **Orbital Motors OMEW Series 0, 1 and 2**



OIL SOLUTIONS

---

**PO Box 38**

**Strathfieldsaye, VIC, 3551**

**1800 OIL SOL**

**1800 645 765**

**[sales@oilsolutions.com.au](mailto:sales@oilsolutions.com.au)**

**[www.oilsolutions.com.au](http://www.oilsolutions.com.au)**

**"For All Your Hydraulic Needs"**



# Contents

<b>Chapter 1: Safety precautions.....</b>	<b>5</b>
<b>Chapter 2: Special versions.....</b>	<b>7</b>
Special versions.....	8
OMEW Series 0, 1 and 2.....	8
Differences between OMEW series.....	8
<b>Chapter 3: Exploded view OMEW, and spare parts.....</b>	<b>11</b>
Exploded view.....	12
Spare parts.....	12
<b>Chapter 4: Disassembly and assembly.....</b>	<b>15</b>
Symbols used in literature.....	16
OMEW disassembly.....	16
OMEW assembly.....	20
<b>Chapter 5: Special tools.....</b>	<b>25</b>
Special tools for OMEW.....	26



---

# Chapter 1

---

## Safety precautions

---

Always consider safety precautions before beginning a service procedure. Protect yourself and others from injury. Take the following general precautions whenever servicing a hydraulic system.



**Warning:**

**Unintended vehicle or machine movement hazard**

When using the RDM in combination with S45 open circuit pumps with LS or EPC be aware that there will likely be motor movement as long as the engine is turning. Due to the LS-setting of the pump, a standby pressure will remain in the system even if the normally closed control is fully energized. Lowest standby pressures to the motor, 15-18bar or above, may be enough to turn the RDM and has the potential to cause injury or damage.



**Warning:**

**Flammable cleaning solvents**

Some cleaning solvents are flammable. To eliminate the risk of fire, do not use cleaning solvents in an area where a source of ignition may be present.



**Warning:**

**Fluid under pressure**

Escaping hydraulic fluid under pressure can have sufficient force to penetrate your skin causing serious injury and/or infection. This fluid may also be hot enough to cause burns. Use caution when dealing with hydraulic fluid under pressure. Relieve pressure in the system before removing hoses, fittings, gauges, or components. Never use your hand or any other body part to check for leaks in a pressurized line. Seek medical attention immediately if you are cut by hydraulic fluid.



**Warning:**

**Personal safety**

Protect yourself from injury. Use proper safety equipment, including safety glasses, at all times.



---

# Chapter

# 2

---

## Special versions

---

### Topics:

- *Special versions*
  - *OMEW Series 0, 1 and 2*
  - *Differences between OMEW series*
-

## Special versions

The list of spare parts cannot be used when ordering parts for special OMEW versions.

In this respect, please contact the sales organisation.

## OMEW Series 0, 1 and 2

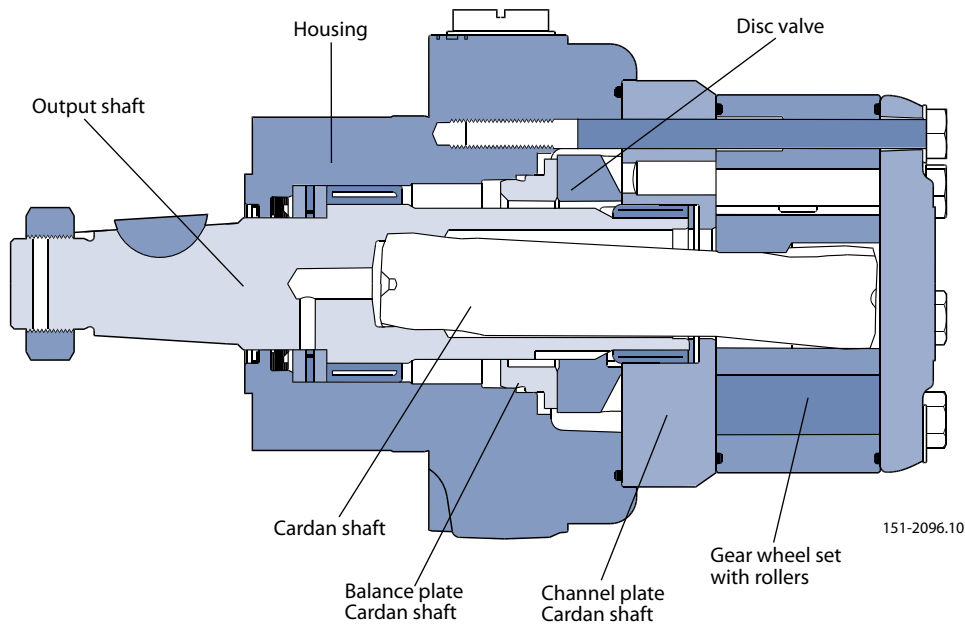

## Differences between OMEW series

**Table 1: Differences between OMEW series**

Item	Description	OMEW Series 0 Metric version Standard	OMEW Series 0 SAE version Standard	OMEW Series 1 SAE version Low speed version	OMEW Series 2 Metric version Standard	OMEW series 2 SAE version Standard	OMEW Series 2 SAE version Low speed version
1	Nut M20	X			X		
1	Nut 1 - 20 UNEF		X	X		X	X
2	Washer 20.5 • 44 • 4	X			X		
4	Housing with M8 screws and O-ring groove Ø96 mm	X	X				
4	Housing with M8 screws and O-ring groove Ø100.5 mm			X			

Item	Description	OMEW Series 0 Metric version Standard	OMEW Series 0 SAE version Standard	OMEW Series 1 SAE version Low speed version	OMEW Series 2 Metric version Standard	OMEW series 2 SAE version Standard	OMEW Series 2 SAE version Low speed version
4	Housing with M10 screws and O-ring groove Ø100.5 mm				X	X	X
5	O-ring 96 • 2	X	X				
5	O-ring 100.5 • 2			X	X	X	X
10	Parallel key 6 • 6 • 2	X			X		
10	Parallel key 1/4 • 1/4 • 1 1/4 in		X				
10	Woodruf key 5/16 • 7/16 • 1 in			X		X	X
11	Shaft metric tap 35 mm Parallel key	X			X		
11	Shaft SAE tap 1 1/4 in Parallel key		X				
11	Shaft SAE tap 1 1/4 in Woodruf key			X		X	X
15	Disc valve, standard	X	X		X	X	
15	Disc valve, LS version 160 - 400 cm <sup>3</sup>			X			X
18	Distributor plate for M8 screws	X	X				
18	Distributor plate for M8 screws and LS-version 160 - 400 m <sup>3</sup>			X			
18	Distributor plate for M10 screws				X	X	
18	Distributor plate for M10 screws and LS-version 160 - 400 m <sup>3</sup>						X
20	O-ring 90 • 2	X	X	X			

<b>Item</b>	<b>Description</b>	<b>OMEW Series 0 Metric version Standard</b>	<b>OMEW Series 0 SAE version Standard</b>	<b>OMEW Series 1 SAE version Low speed version</b>	<b>OMEW Series 2 Metric version Standard</b>	<b>OMEW series 2 SAE version Standard</b>	<b>OMEW Series 2 SAE version Low speed version</b>
20	O-ring 92.6 • 2				X	X	X
21	Gearwheel set for M8 screws	X	X	X			
21	Gearwheel set for M10 screws				X	X	X
22	End cover for M8	X	X	X			
22	End cover for M10				X	X	X
24	Washer 8.2 • 15.2 • 2	X	X	X			
24	Washer 10.5 • 20 • 2				X	X	X
25	Screws M8	X	X	X			
25	Screws M10				X	X	X

---

# Chapter

# 3

---

## Exploded view OMEW, and spare parts

---

### Topics:

- *Exploded view*
  - *Spare parts*
-

## Exploded view

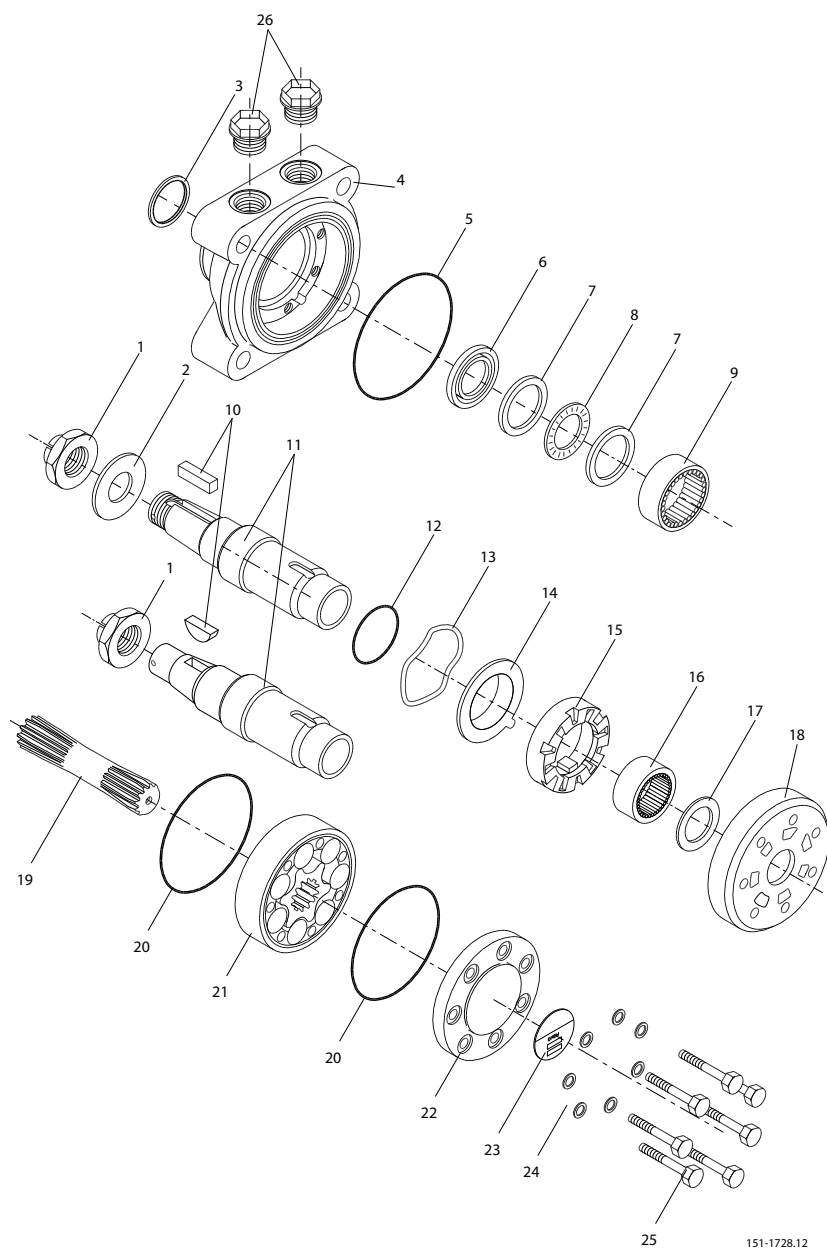

**Table 2: Tightening torque**

	OMEW Series 0 and 1	OMEW Series 2
Item 25	35 - 40 N•m [309.77 - 354.03 lbf•in]	75 - 80 N•m [663.80 - 708.06 lbf•in]

## Spare parts

Set of seals OMEW series 0, 1 and 2	Code number
Seal set incl. items: 3, 5, 6, 12, 20, 24	11105376

Spare parts		Series 0		Series 1	Series 2	
		Metric version	SAE version	SAE version	Metric version	SAE version
Nut item 1	M20	681X8235	-	-	681X8235	-
Nut item 1	1- 20 UNEF	-	151-4154	151-4154	-	151-4154
Washer item 2	20.5 • 44 • 4	684X2530	-	-	684X2530	-
Parallel key item 10	6 • 6 • 20	682L8021	-	-	682L8021	-
Parallel key item 10	¼ • ¼ • 1¼	-	151-4109	-	-	-
Woodruff key item 10	5/16 • 7/16 • 1	-	-	682L9152	-	682L9152



---

# Chapter

# 4

---

## Disassembly and assembly







---

### Topics:

- *Symbols used in literature*
  - *OMEW disassembly*
  - *OMEW assembly*
-

## Symbols used in literature

---

-  = Pull out with tool - press fit
-  = Non removable part, use a new part
-  = External hex head
-  = Mark orientation for reinstallation
-  = Press in - press fit
-  = Torque specification
-  = Note correct orientation

## OMEW disassembly

---

1.

To ensure correct assembly/location of motor parts, provide identification marks.

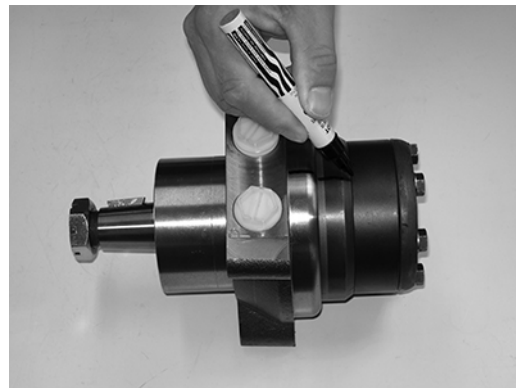

F301 506

2.

Remove nut (1), parallel key (10) and plastic plugs (26).



F301 507

3.

Fix motor in holding tool SJ 151- 9000-1 and holding plate SJ 9000-14.

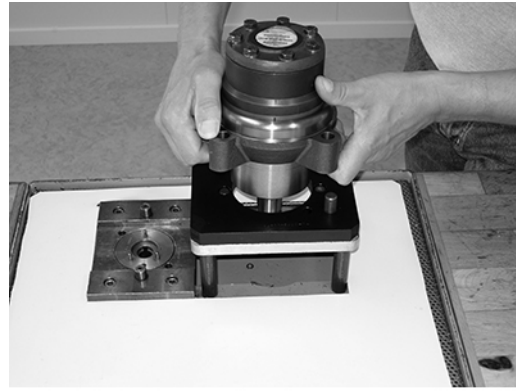

F301 518

4.

**OMEW series 0 and 1:**  With a h13 mm key loosen the seven bolts (25) in the end cover.

**OMEW series 2:**  with a h16 mm key loosen the seven bolts (25) in the end cover.

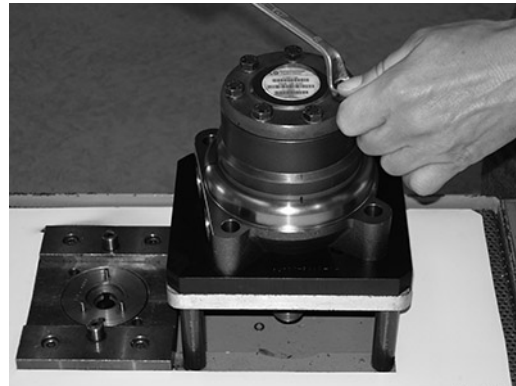

F301 524

5.

Lift end cover (22).



F301 521

6.

Take out gear wheel set (21) and O-ring (20). 

**Note:** Rollers in gearwheel set can fall out.

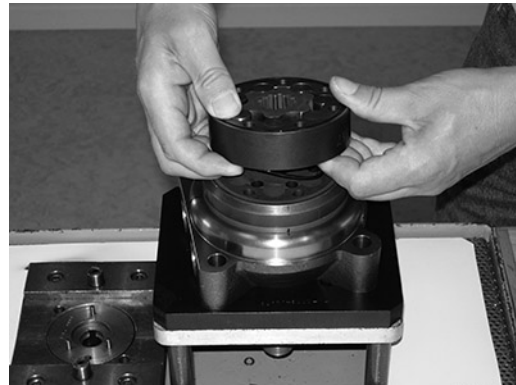

F301 526

7.

Remove cardan shaft (19).

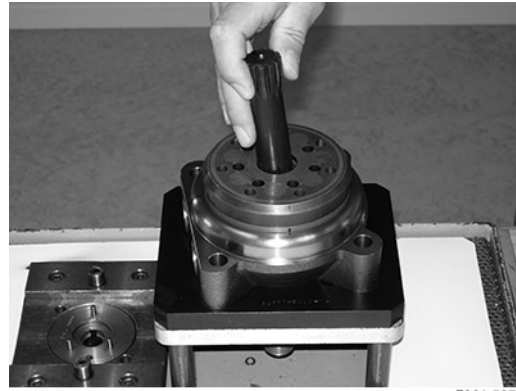

F301 527

8.

Remove distributor plate (18) and O-ring (5).  The needles will fall out of the needle bearing (16) during dismantling and can be collected for reuse. The outer ring and thrust bearing (17) need not be removed.

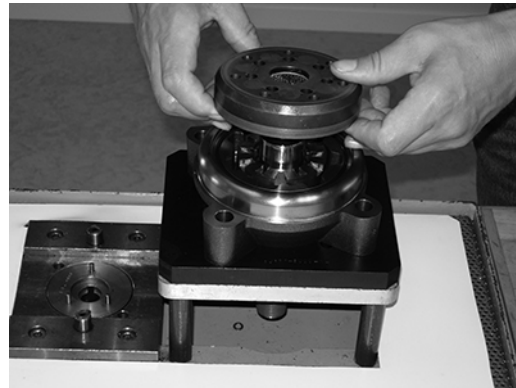

F301 519

9.

Remove disc valve (15)



F301 529

10.

Remove shaft (11) With the housing standing on the work bench, press the shaft out of the housing. Collect the needles for possible reuse.

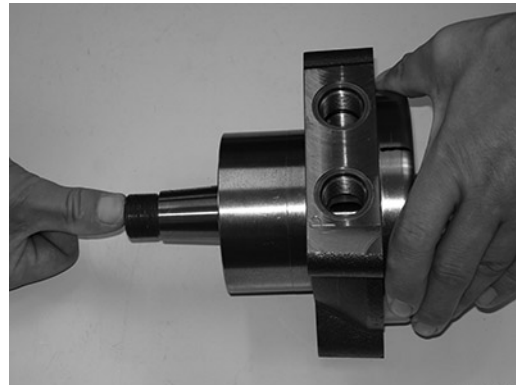

F301 530

11.

Remove balance plate (14), O-ring  (12) and spring washer (13).

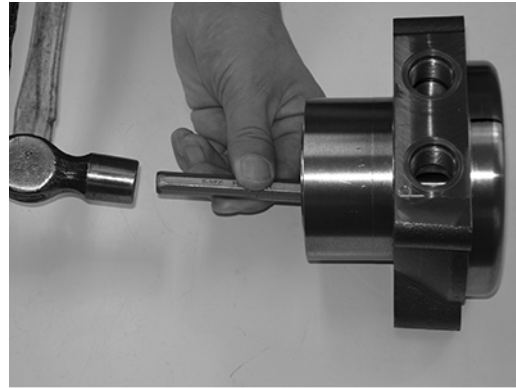

F301 508

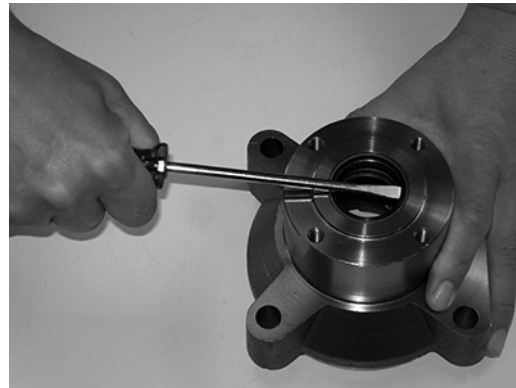

12.

Turn the housing. Gently lever the dust seal ring (3) from the housing with a screwdriver. 



F301 509

13.

Fit the extractor between housing and shaft seal. Press shaft seal (6) , bearing race (7), axial needle bearing (8) and radial needle bearing (9) out using hydraulic pressure equipment. 



F301 510

After dismantling, clean all parts in low aromatic kerosene. Replace all O-rings and shaft seal. Immediately before assembly, lubricate all parts with hydraulic oil and grease rubber parts with vaseline.

## OMEW assembly

---

1.

Place the shaft seal (6) on mandrel SJ 151-9000-18 and mount the shaft seal into the motor housing (4)

**Note:** Remember a new shaft seal.

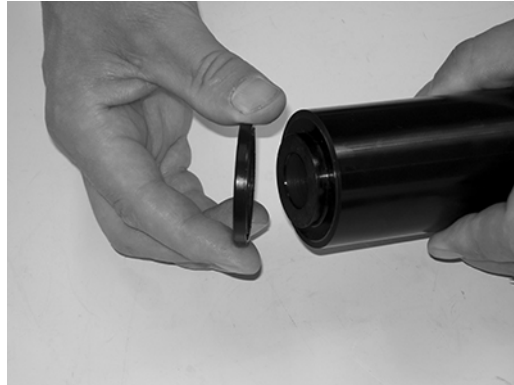

F301 511

2.

Mount the bearing race (7) (2 off) and the axial needle bearing (8)

**Note:** The bearing race can be fitted in any position.

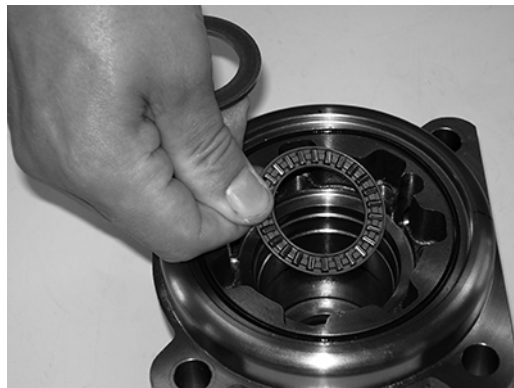

F301 512

3.

Place the needles in the outer ring and hold them in place with grease. Now place the whole bearing in the housing. Press the bearing into position with mandrel SJ

151-9000-18 



F301 513

4.

Carefully insert shaft through housing.

**Note:** Cover the groove with installation sleeve.

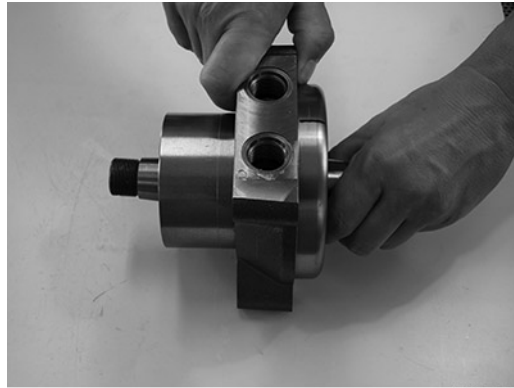

F301 514

5.

Place O-ring (5) in housing

**Note:** Remember new O-ring

O-ring dimensions:

Series 0: 96 • 2 mm

Series 1 and 2: 100.5 • 2 mm

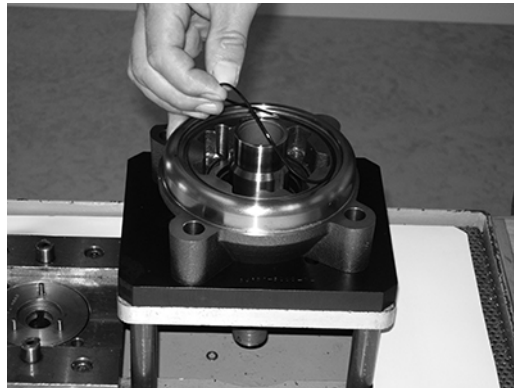

F301 515

6.

Place spring washer (13) on balance plate (14), insert O-ring (12) in recess and lubricate with grease. Place balance plate lightly in position so that it engages. Be careful not to damage the O-ring.

**Note:** Remember new O-ring

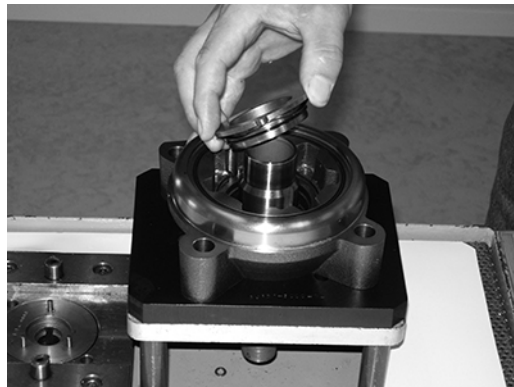

F301 516

7.

Place disc valve (15) on the shaft upwards so that the long tap on the disc valve engages with the slot in the shaft.

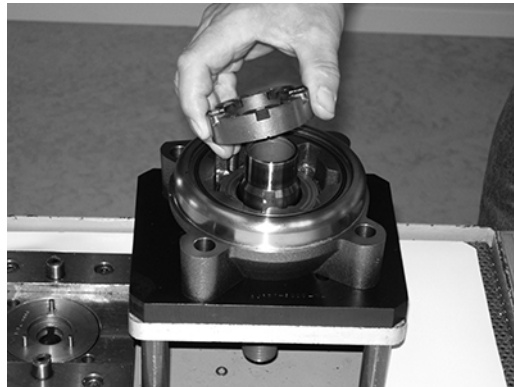

F301 517

8.

If there is a difference in the spline length, fit the cardan shaft (19) with the long-spline end in the output shaft. Mark the bottom of the cardan shaft spline that lies adjacent to long tap in the disc valve.

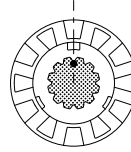

151-1730.10

9.

Place the needles in the outer ring and hold them in place with grease. Carefully place the distributor plate (18) on the bearing housing so that the shaft enters the bearing. Press the distributor plate until it stops on the housing and line up the screw holes.

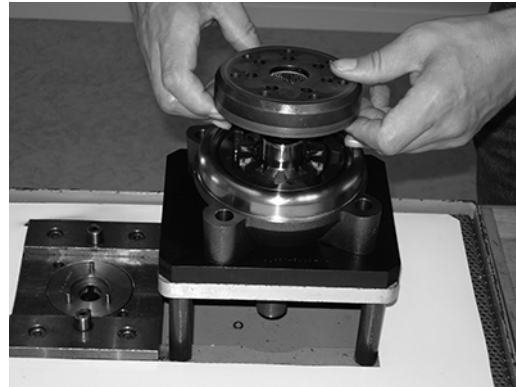

F301 519

10.

Place the greased O-rings (20) in the gearwheel O-ring recesses. If there is a recess on one end of the spline hole, position the gearwheel with recess on the same side as the smallest screw hole (stage hole) in the gearwheel rim. Fit the gearwheel set with this side facing the housing.

**Note:** Remember new O-ring

O-ring dimension:

Series 0 and 1: 90 • 2 mm

Series 2: 92.6 • 2 mm



F301 520

11.

*Clockwise revolution (CW)*  Fit the gearwheel set on the cardan shaft so that the top of a tooth in the external teeth of the gearwheel is vertically over the mark on the cardan shaft. Turn the gearwheel set **counterclockwise** until cardan shaft and gearwheel engage (15°). Turn the gearwheel set rim to line up the screw holes.

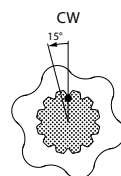

151-1731.10

12.

*Counter clockwise revolution (CCW)*  Fit the gearwheel set on the cardan shaft so that the top of a tooth in the external teeth of the gearwheel is vertically over the mark on the cardan shaft. Turn the gearwheel set **clockwise** until cardan shaft and gearwheel engage (15°). Turn the gearwheel set rim to line up the screw holes.

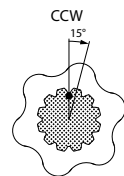

151-1732.10

**13.**

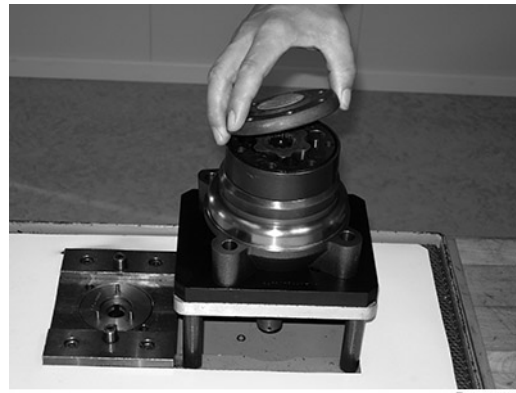

Place the end cover (22) on the gear wheel set and line up the screw holes



F301 521

**14.**

OMEW series 0 and 1 With a  13 mm socket spanner tighten the bolts. (25) Tightening torque: 35 - 40 N•m

 OMEW series 2 With a  16 mm socket spanner tighten the bolts. (25) Tightening torque: 75 - 80

N•m 

**Note:** Remember new O-ring

Washer dimensions:

Series 0 and 1: 8.2 • 15.2 • 1.6

Series 2: 10.5 • 20 • 2

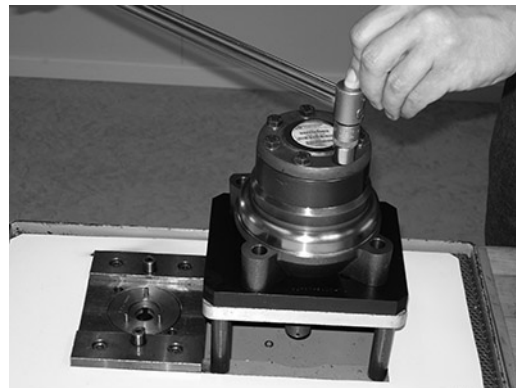

F301 522

**15.**

Fit the dust seal ring (3) into place with a plastic hammer and suitable mandrel.

**Note:** Remember new dust seal



F301 523

**16.**

Mount the woodruff key (10), nut (1), plastic plugs (26) and washer (2).

**Note:** SAE versions do not have washer



F301 507



---

# Chapter

# 5

---

## Special tools

---

### Topics:

- *Special tools for OMEW*
-

## Special tools for OMEW

---

Main holding tool (horse hole): Code No.: SJ 151-9000-1.



F300 083

Holding tool for OMEW: Code No.: SJ 151-9000-14.



F300 129

Mandrel tool SJ151 - 9000-18

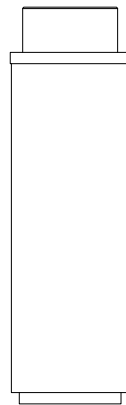

151-1733.11

Standard tool STAHLWILL 11060 - 5



