

Repair Instructions Orbital Motors OMH



OIL SOLUTIONS

PO Box 38

Strathfieldsaye, VIC, 3551

1800 OIL SOL

1800 645 765

sales@oilsolutions.com.au

www.oilsolutions.com.au

"For All Your Hydraulic Needs"

Contents

Chapter 1: Special Versions and Cost-free Repairs.....	5
Special Versions.....	6
Cost-free Repairs.....	6
OMH	6
Safety Precautions.....	6
Chapter 2: Exploded View.....	9
Exploded View OMH, and Spare Parts.....	10
Chapter 3: Spare Parts.....	11
Chapter 4: Set of Seal.....	15
Chapter 5: Disassembly.....	17
Disassembly.....	18
Chapter 6: Assembly.....	23
Assembly.....	24
Chapter 7: Special Tools.....	29
Special tools.....	30
Chapter 8: Notes.....	31
Notes.....	32

Chapter

1

Special Versions and Cost-free Repairs

Topics:

- *Special Versions*
 - *Cost-free Repairs*
 - *OMH*
 - *Safety Precautions*
-

Special Versions

The list of spare parts cannot be used when ordering parts for special OMH versions.

In this respect, please contact the sales organisation.

Cost-free Repairs

Please note that cost-free repairs as mentioned in General Conditions of Sale, are carried out only at service shops authorised by the organization.

OMH

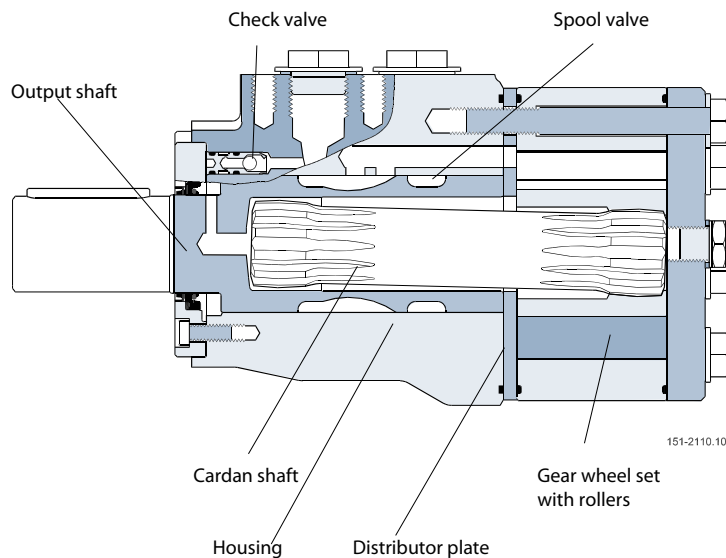

Safety Precautions

Always consider safety precautions before beginning a service procedure. Protect yourself and others from injury. Take the following general precautions whenever servicing a hydraulic system.

Unintended machine movement



Warning:

Unintended movement of the machine or mechanism may cause injury to the technician or bystanders. To prevent unintended movement, secure the machine or disable / disconnect the mechanism while servicing.

Flammable cleaning solvents



Warning:

Some cleaning solvents are flammable. To eliminate the risk of fire, do not use cleaning solvents in an area where a source of ignition may be present.

Fluid under pressure



Warning:

Escaping hydraulic fluid under pressure can have sufficient force to penetrate your skin causing serious injury and/or infection. This fluid may also be hot enough to cause burns. Use caution when dealing with hydraulic fluid under pressure. Relieve pressure in the system before removing hoses, fittings, gauges, or components.

Never use your hand or any other body part to check for leaks in a pressurized line. Seek medical attention immediately if you are cut by hydraulic fluid.

Personal safety



Warning:

Protect yourself from injury. Use proper safety equipment, including safety glasses, at all times.

Chapter

2

Exploded View

Topics:

- *Exploded View OMH, and Spare Parts*

Exploded View OMH, and Spare Parts

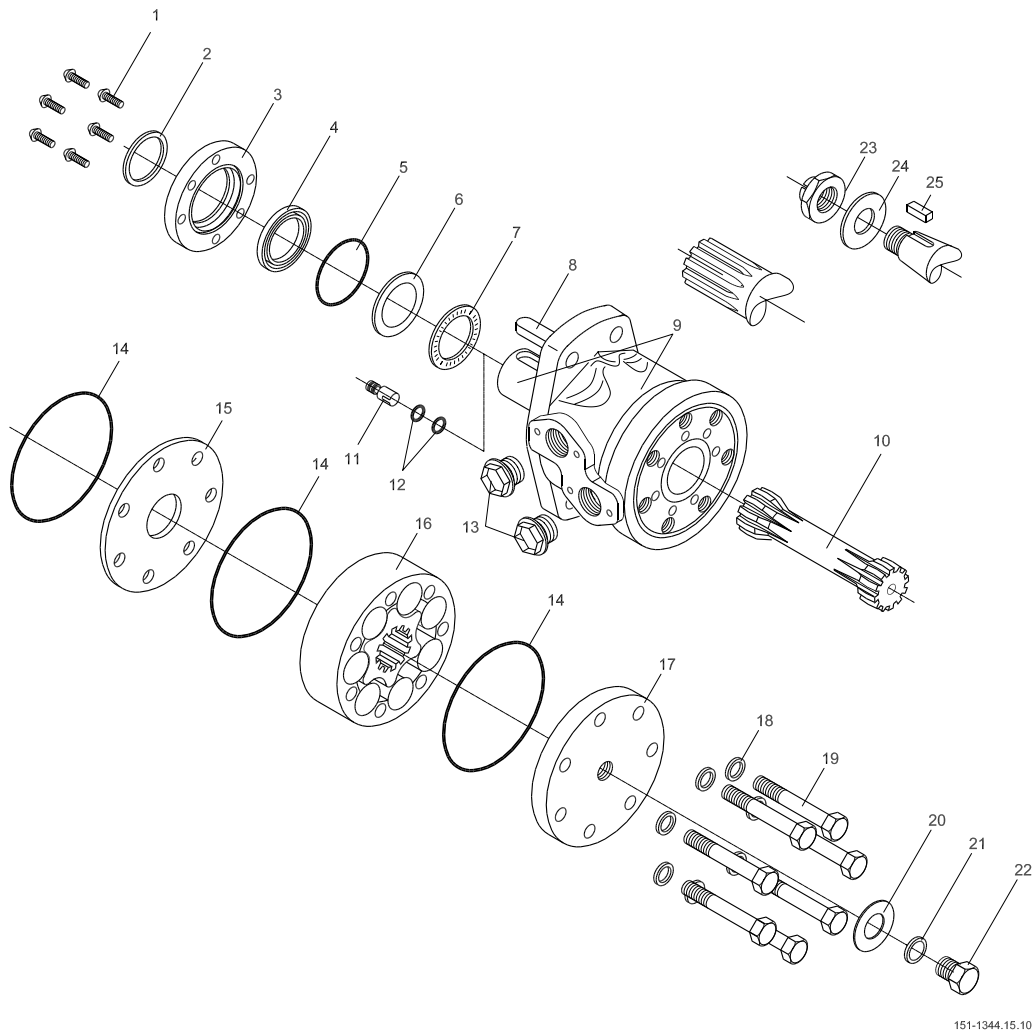

Table 1: Tightening torque

Item	N•m	lbf•in
1	5 - 8	45 - 70
19	52 - 57	460 - 500
22	30 - 60	265 - 530
23	190 - 210	1680 - 1860

Chapter 3

Spare Parts

Item	Spare Part	Dimensions	Code no.	Number per motor
1	Screw	M6: l = 20 mm, Torx T30	681X1989	6
2	Dust seal ring	28.56 • 35 • 4 mm 36 • 42 • 3.5 mm	151-1313 633B3396	1 1
3	Spigot flange		151H0386 151H0301	1 1
4	Shaft seal	28.56 • 42 • 5.5 mm NBR 36 • 48 • 5.5 mm NBR	633B3385 633B3395	1 1
5	O-ring	53 • 2 mm	633B1528	1
6	Bearing race	37 • 52 • 3 mm	11046900	1
7	Axial needle bearing	36 • 52 • 3 mm	11046899	1
8	Parallel key ø 32 mm and ø 35 mm	A10 • 8 • 45	682L8019	1
	Parallel key ø 1 ¼"		151-4109	1
9	Housing and output shaft		Not sold separately	

Item	Spare Part	Dimensions	Code no.	Number per motor
10	Cardan shaft	OMH 200 L =	151H0338	1
		124.5 mm	151H0339	1
		OMH 250 L =	151H0340	1
		131.5 mm	151H0341	1
		OMH 315 L =	151H0342	1
		140.0 mm		
		OMH 400 L =		
		151.5 mm		
		OMH 500 L =		
		161.5 mm		
11	Check valve	(incl. Item 12	151-1076	2
13	Seal plug	½“ EU -version	633X0074	2
		7/8 - 14 UNF US-version	633X0017	2
14	O-ring	105 • 2 mm	633B1807	3
15	Distributor plate		151H0305	1
16	Gearwheel set	OMH 200 L =	151H1253	1
		27.8 mm	151H1254	1
		OMH 250 L =	151H1255	1
		34.8 mm	151H1256	1
		OMH 315 L =	151H1257	1
		43.5 mm		
		OMH 400 L =		
		54.8 mm		
		OMH 500 L =		
		65.0 mm		
17	End cover	¼” EU-version	151H0310	1
		7/16 - 20 UNF US version	151H0311	1
18	Washer	10.5 • 20 • 2 mm	684X1090	7

Item	Spare Part	Dimensions	Code no.	Number per motor
19	Screw M10 • 1.5	OMH 200 L =	681X1501	7
		65.0 mm	681X1502	7
		OMH 250 L =	681X1503	7
		70.0 mm	681X0388	7
		OMH 315 L =	681X1347	7
		80.0 mm		
		OMH 400 L =		
		90.0 mm		
		OMH 500 L =		
		100.0 mm		
20	Name plate			1
21	Washer	13.5 • 1.0 mm	684X2120	1
22	Drain plug	¼" EU-version	151-1524	1
		7/16 - 20 UNF US version	151-5439	1
23	Castellated nut	M 20 • 1.5	681X8235	1
24	Washer	20.5 • 1.0	684X2530	1
25	Parallel key tapered	B6 • 6 • 20 mm	684L8021	1

Chapter

4

Set of Seal

Set of seal OMH	Code number
Seal set incl. items 2, 4, 5, 14, 18 and 21	
OMH with ø32 mm shaft, ø35 mm shaft, ø1 ¼" shaft, 1 ¼" splined and 35 mm tapered shaft	151H1100
OMH with 1" splined shaft 6B	151H1102

Chapter

5

Disassembly

Topics:

- [Disassembly](#)

Disassembly

1. To ensure correct assembly/location of motor parts, provide identification marks. 

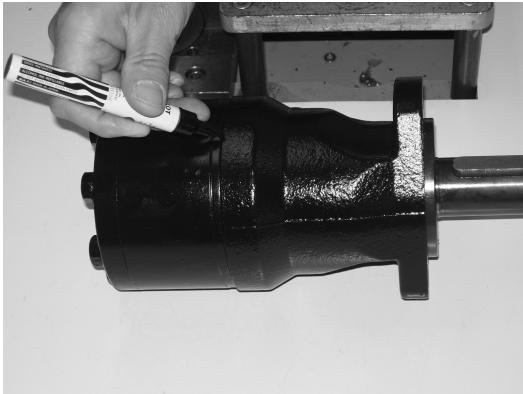



2. Remove parallel key (8 or 25) on cylindrical or tapered shafts, nut (24) on tapered shaft and plastic plugs (13).



3. Fix motor in holding tool SJ 151-9000-1.



4. With a  16 mm key loosen the seven bolts (19) in the end cover. Remove washers (18) .

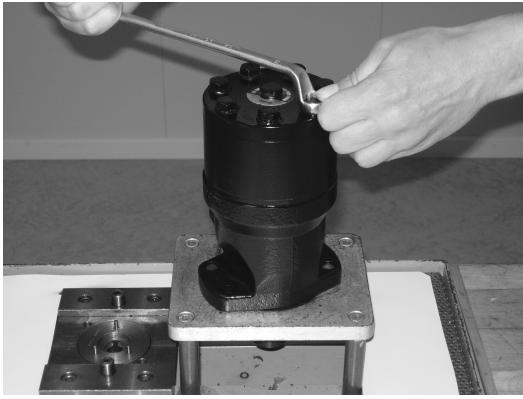

5. Lift end cover (17)

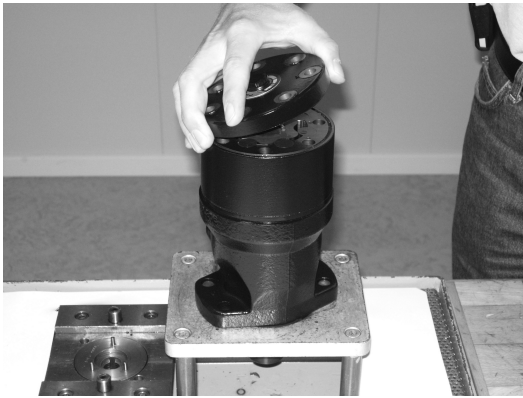

6. Take out gear wheel set (16) and O-rings (14). 

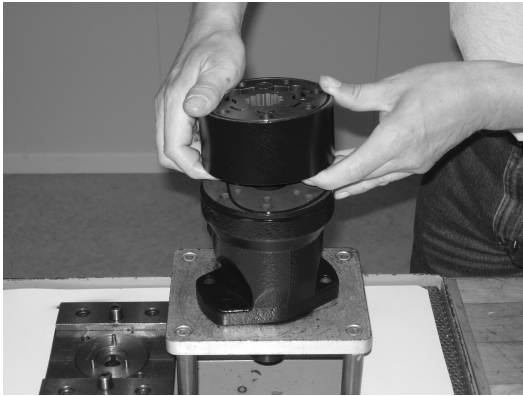

7. Remove cardan shaft (10).



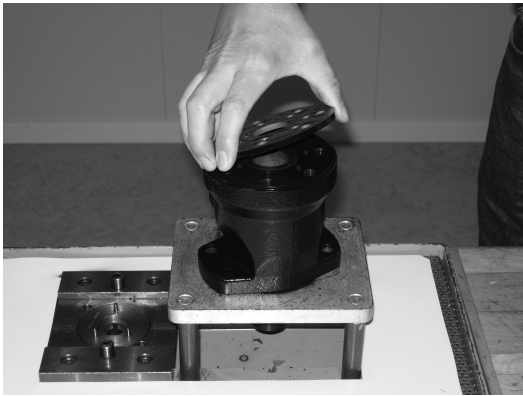

8. Remove distributor plate (15) and O-ring (14). 

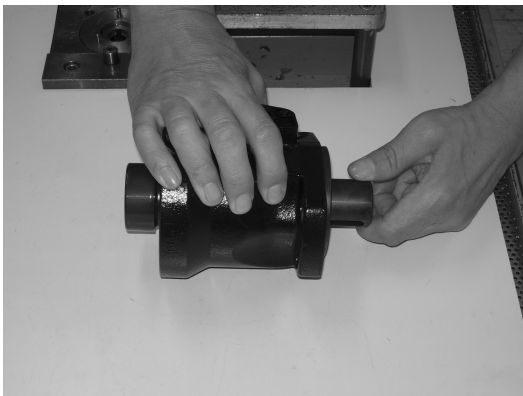

9. Remove output shaft. With the housing standing on the working table, press the shaft out of the housing.



10. With a torx-spanner T30  loosen six screws (1) in the spigot flange (3). Remove the axial needle bearing (7), bearing race (6) and O-ring (5). 



11. Press out shaft seal $\varnothing 36$ mm (6) with mandrel SJ151H9000-1 and shaft seal $\varnothing 28.56$ mm (6) with mandrel SJ 151-9000-7 by using hydraulic pressure equipment. 

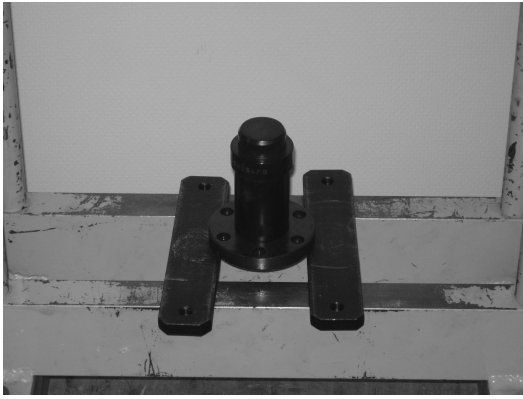

12. Remove the check valves (11) with ground 3.5 mm screw tap

After dismantling, clean all parts in low aromatic kerosene.

Replace all O-rings and shaft seal.

Immediately before assembly, lubricate all parts with hydraulic oil and grease rubber parts with vaseline.

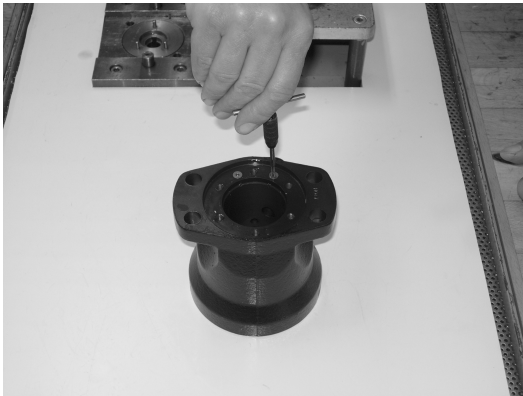

Chapter

6

Assembly

Topics:

- [Assembly](#)

Assembly

1. Place the shaft seal $\varnothing 36$ mm (6) on mandrel SJ 151-9000-1 or the shaft seal $\varnothing 28.56$ mm (6) on mandrel SJ 159000-7 and mount the shaft seal in the spigot flange (3) by using hydraulic pressure equipment. 

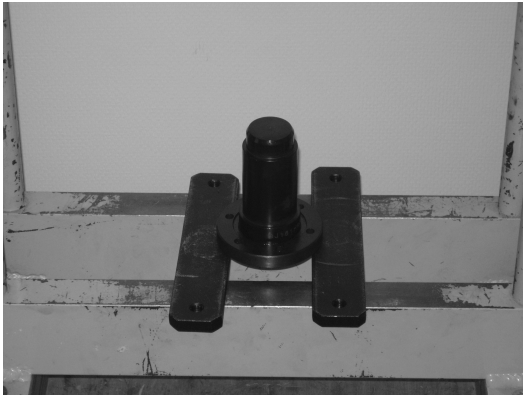

2. Mount the check valves (11) in their bores and fit them with a light blow of a plastic hammer.

Remember new O-rings!



3. The rear shaft end must be marked before fitted. The mark must be positioned vertically above a commutation slot leading up to the front annular channel. 

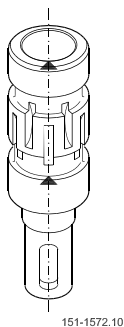

4. Carefully insert shaft through housing.

Note:

Cover the groove with installation sleeve.



5. Mount the bearing race (6), the axial needle bearing (7) and O-ring (5) in the spigot flange (3)

Remember new O-ring



6. Place the spigot flange on the housing (9) and mount the screws (1) (6 off). With a torx-spanner T30 tighten the screws. 

Tightening torque: 5 - 8 N•m [45 - 70 lb•in] 

Place the motor housing with shaft downward on the holding tool SJ 151-9000-1



7. Guide the cardan shaft (10) down into the motor housing. In case of different splines length turn the cardan shaft to ensure the long end is fitted in the output shaft.

Transfer marking from output shaft to cardan shaft. 

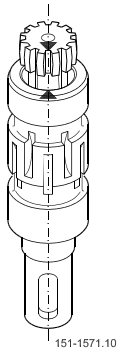

8. Mount distributor plate (15) and O-ring (14) on motor housing.

Remember new O-ring!

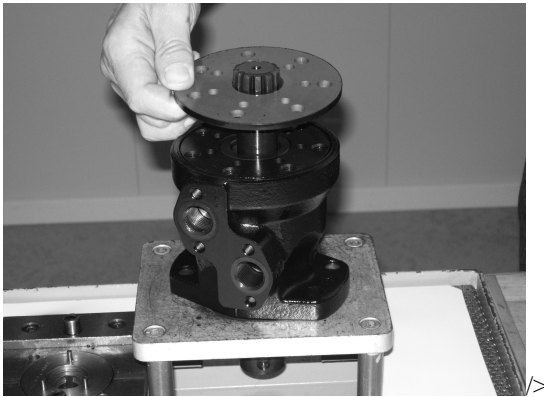

9. Place the O-rings (14) in the O-ring groove of the gear wheel set (16).

Remember new O-ring!

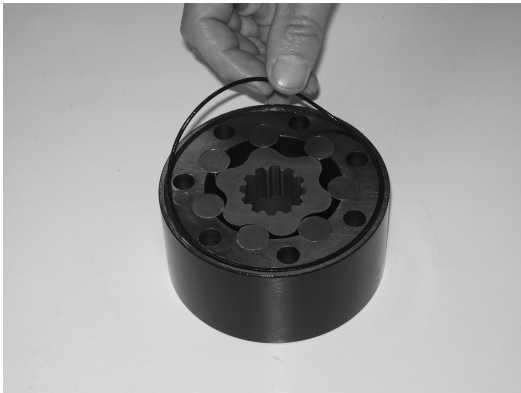

10. In gearwheel set with non through splines place the gearwheel set with the recess in the spline hole facing down towards the housing. Place the gearwheel set (16) on the cardan shaft so that the top of a tooth in the external teeth of the gearwheel is vertically above the mark on the cardan shaft.

Turn the gearwheel set counter clock-wise until cardan shaft and the gear wheel start to mesh (15°). 

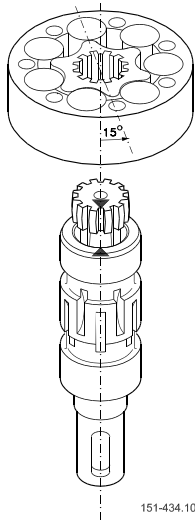

Turn the gearwheel set rim to line up the screw holes.

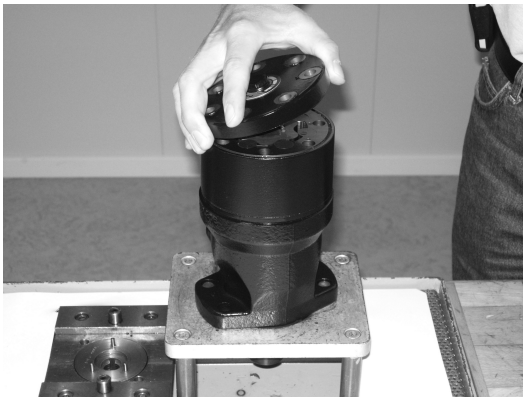

11. Mount the end cover (17)

Remember new O-ring!



12. Renew the washer (18) and mount the screws (19). With 16 mm spanner  cross tighten the screws. Tightening torque: 52 - 57 N•m [460 - 500 lbf•in]. 

Remember new washers!

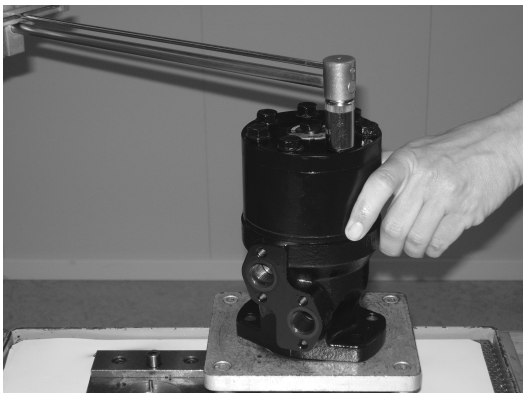

13. After testing the motor fit the dust seal (2) into place with a plastic hammer and suitable mandrel.

Remember new dust seal!

Mount the parallel key (8 or 25), nut (23) and plastic plugs (13).



Chapter

7

Special Tools

Topics:

- *Special tools*
-

Special tools



Main holding tool (horse shoe):

Code No.: SJ 151-9000-1.

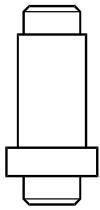

151-2097.10

Mandrel for shaft seal $\varnothing 36$ mm

SJ151H9000-1

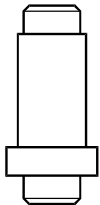

151-2097.10

Mandrel for shaft seal $\varnothing 28.56$ mm

SJ151-9000-7



= Pull out with tool - press fit



= Non removable part, use a new part



= External hex head



= Mark orientation for reinstallation



= Press in - press fit



= Torque specification



= Note correct orientation

Chapter

8

Notes

Topics:

- [Notes](#)

Notes
