

Repair Instructions Orbital Motors OML and OMM



OIL SOLUTIONS

PO Box 38

Strathfieldsaye, VIC, 3551

1800 OIL SOL

1800 645 765

sales@oilsolutions.com.au

www.oilsolutions.com.au

"For All Your Hydraulic Needs"

Contents

Chapter 1: Safety Precautions.....	5
Chapter 2: Special Versions and Cost-free Repairs.....	7
Special Versions.....	8
Cost-Free Repairs.....	8
OML.....	8
OMM.....	8
Chapter 3: OML.....	9
Exploded view.....	10
Spare Part List.....	10
Chapter 4: Dismantling OML / Cleaning.....	13
Dismantling.....	14
Cleaning	14
Symbols used in literature.....	15
Chapter 5: Assembly OML.....	17
Assembly.....	18
Chapter 6: OMM.....	21
Exploded view.....	22
Spare Parts OMM.....	22
Chapter 7: Dismantling OMM / Cleaning.....	25
Dismantling.....	26
Cleaning	26
Chapter 8: Assembly OMM.....	27
Assembly.....	28
Chapter 9: Tools.....	31

Chapter 1

Safety Precautions

Always consider safety precautions before beginning a service procedure. Protect yourself and others from injury. Take the following general precautions whenever servicing a hydraulic system.



Warning:

Unintended Machine Movement

Unintended movement of the machine or mechanism may cause injury to the technician or bystanders. To protect against unintended movement, secure the machine or disable / disconnect the mechanism while servicing.



Warning:

Flammable Cleaning Solvents

Some cleaning solvents are flammable. To avoid possible fire, do not use cleaning solvents in an area where a source of ignition may be present.



Warning:

Fluid Under Pressure

Escaping hydraulic fluid under pressure can have sufficient force to penetrate your skin causing serious injury and/or infection. This fluid may also be hot enough to cause burns. Use caution when dealing with hydraulic fluid under pressure. Relieve pressure in the system before removing hoses, fittings, gauges, or components. Never use your hand or any other body part to check for leaks in a pressurized line. Seek medical attention immediately if you are cut by hydraulic fluid.



Warning:

Personal Safety

Protect yourself from injury. Use proper safety equipment, including safety glasses, at all times.

Chapter

2

Special Versions and Cost-free Repairs

Topics:

- *Special Versions*
 - *Cost-Free Repairs*
 - *OML*
 - *OMM*
-

Special Versions

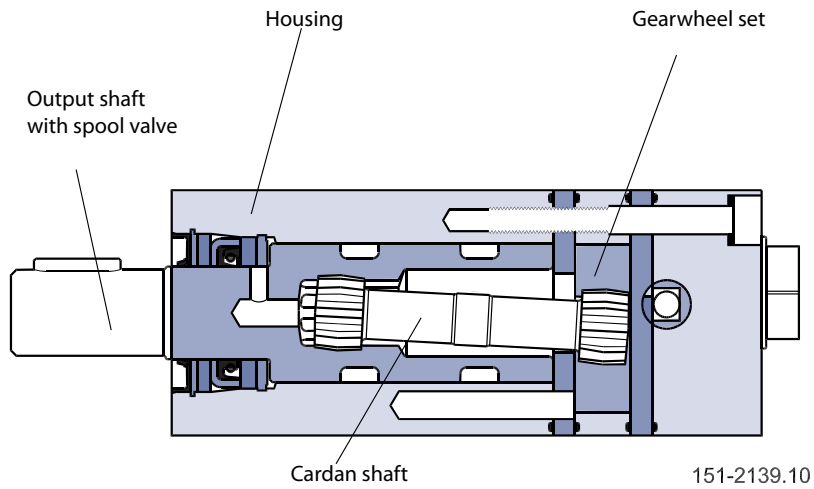
The list of spare parts cannot be used when ordering parts for special OML/OMM versions.

In this respect, please contact the sales organisation.

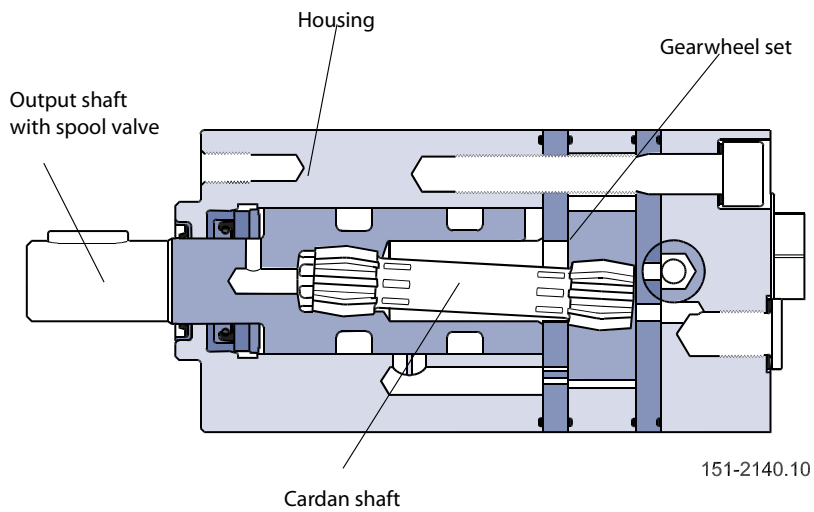
Cost-Free Repairs

We would point out that cost-free repairs as mentioned in General Conditions of Sale, are carried out only at service shops authorised by the organization.

OML



OMM



Chapter

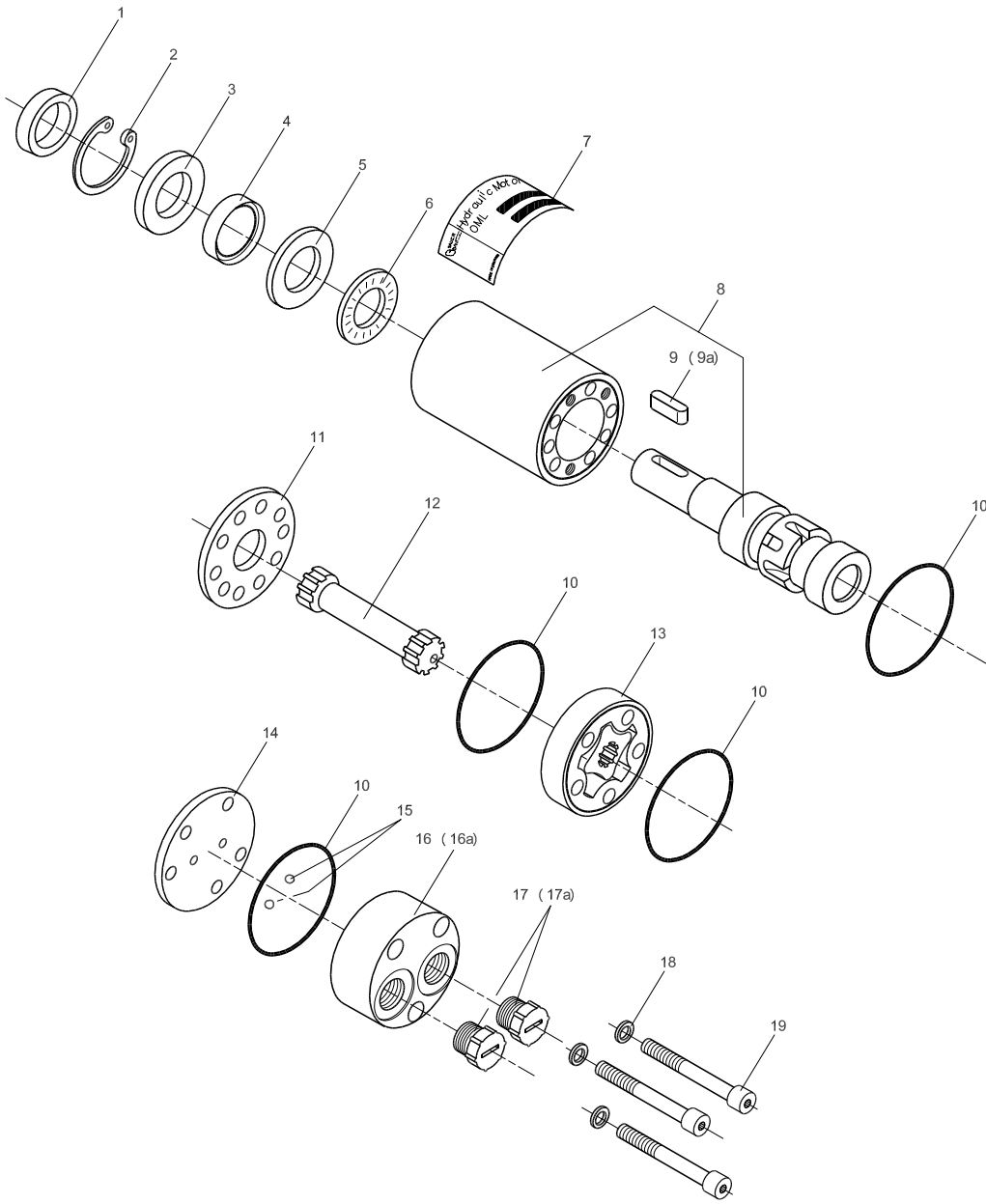
3

OML

Topics:

- *Exploded view*
 - *Spare Part List*
-

Exploded view



151-1323.10

Tightening torque: item 19
 5 - 9.5 N•m [66 - 84 lbf•in]

Spare Part List

Item	Spare Part	Dimensions	Code no.	Number per motor
1*	Dust seal ring	29 • 17 • 3.2 mm	633B3398	1

Item	Spare Part	Dimensions	Code no.	Number per motor
2	Retaining ring	29 • 1.2 mm	682L4213	1
3	Support ring	28.8 • 17.35 • 2.45 mm		1
4*	Shaft seal BAKHD NBR	28 • 17 • 5.5 mm	633B3208	1
4	Shaft seal BAHD FPM	28 • 17 • 5.5 mm	633B3390	1
5	Bearing race	27.8 • 17.1 • 3.0 mm	151G0307	1
6	Needle bearing	27.9 • 17.1 • 2.0 mm	151G2300	1
7	Label			
8	Housing and output shaft	not sold separately		
9	Parallel key metric version	16 • 5.0 • 5.0 mm DIN 6885	682L8026	1
9a	Parallel key SAE version	3/16 • 3/16 • 3/4 inch B.S. 46	682L8031	1
10*	O-ring	42 • 1.0 mm	633B1027	4
11	Distributor plate	45 • 14.6 • 4.0	151G2303	1
12	Cardan shaft OML 8	l = 51.5 mm	151G2314	1
	Cardan shaft OML 12.5	l = 53.8 mm	151G2315	1
	Cardan shaft OML 20	l = 57.6 mm	151G2316	1
	Cardan shaft OML 32	l = 63.7 mm	151G2317	1
13	Gearwheel set OML 8	w = 4.1 mm	151G2101	1
	Gearwheel set OML 12.5	w = 6.4 mm	151G2102	1
	Gearwheel set OML 20	w = 10.2 mm	151G2103	1
	Gearwheel set OML 32	w = 16.3 mm	151G2104	1
14	Intermediate plate	45 • 4.0 mm	151G2305	1
15	Check valve	4.76	689X1005	2
16	End cover, metric version	G 1/4 in ports	151G2331	1
16a	End cover, SAE version	7/16 - 20 UNF	151G2333	1
17	Seal plug metric version	G 1/4 in ports	633X0028	2
17a	Seal plug SAE version	7/16 - 20 UNF	633X7026	2

Item	Spare Part	Dimensions	Code no.	Number per motor
18*	Washer	8.82 • 5.39 • 1.0 mm	684X2012	3
19	Screw M5OML 8/12.5	l = 40 mm	681X1511	3
	Screw M5OML 20	l = 45 mm	681X1512	3
	Screw M5OML 32	l = 50 mm	681X1702	3
Set of Seals				
*	Seal kit OML incl. items 1, 4, 10 and 18		151G2201	

Chapter






4

Dismantling OML / Cleaning

Topics:

- *Dismantling*
 - *Cleaning*
 - *Symbols used in literature*
-

Dismantling

Item	Part to Remove	Comments
9	Parallel key	Remove parallel key
17	Seal plugs	Put the motor in a holding tool with the output shaft lowest and remove the seal plugs.
18, 19	Screws	Use a 4 mm Allan key.
16	End cover	
10	O-ring	Remove end cover sideways. Beware of the two check valve. Remove O-ring. 
15	Balls	
14	Intermediate plate	Remove intermediate plate.
13	Gearwheel set	Hold fingers under the gearwheel set to prevent the gear from dropping out.
10	O-rings	
12	Cardan shaft	Remove cardan shaft.
13	Distributor plate	Remove distributor plate.
12	O-ring	
	Output shaft	Take output shaft out of housing and turn motor.
1	Dust ring	Remove dust seal by means of a screwdriver. 
2	Snap ring	Remove retaining ring by means of pair of pliers.
3	Support ring	Remove support ring.
4	Shaft seal	Press shaft seal  bearing race and needle bearing through shaft end of housing
5	Bearing race	by means of the output shaft, possibly using the cardan shaft.
6	Needle bearing	

Cleaning

Cleaning

Clean all parts carefully with low aromatic kerosine.

Inspection and replacement

Check all parts carefully and replace if necessary.

Lubrication

Before assembly, lubricate all parts with hydraulic oil and grease rubber parts with vaseline.

Symbols used in literature



= Pull out with tool - press fit



= Non removable part, use a new part



= Internal hex head



= Mark orientation for reinstallation



= Press in - press fit



= Torque specification



= Note correct orientation

Chapter

5

Assembly OML

Topics:

- *Assembly*
-

Assembly

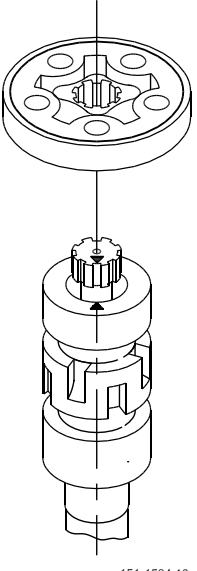


Item	Part to Install	Comments
5	Needle bearing	Fit needle bearing in shaft end of motor housing. Put thrust bearing race without chamfering on top and needle bearing.
6	Bearing race	
8	Output shaft	
4	Shaft seal	Fit shaft seal in motor housing by means of mandrel and plastiv hammer.
3	Support ring	Install support ring with champfering in motor housing. Turn chamfering against shaft seal.
2	Snap ring	Install snap ring in motor housing by means of a pair of pliers.
1	Dust seal	Knock dust seal into position in motor housing using a plastic hammer.
	 <p>151-1534.10</p>	<p>Mark output shaft at middle of two commutating grooves. Install shaft in motor housing. </p> <p>See drawing 151 - 1534.10</p>
9	Key	Fit key in output shaft. Place motor housing with shaft in holding tool.
10	O-ring	Grease the O-ring and put in the O-ring groove of the housing.
12	Cardan shaft	Guide the cardan shaft down into the output shaft. Place the fork (tool) under the upper cardan shaft teeth. Transfer the mark from output shaft to cardan shaft. The drawing 151-1534.10
11	Distributor plate	Turn the distributor plate so that the holes line up.
10	O-ring	Place O-ring (greased) in O-rings grooves of gear rim.

Figure 1: Output shaft

Item	Part to Install	Comments
13	Gearwheel set	Place gearwheel set on cardan shaft so that the mark on the cardan shaft is opposite a tooth peak on the external tothing of the gearwheel- Turn the tooth rim till holes for screws line up- See drawing 151-1534.10.
14	Intermediate plate	Fit intermediate plate on gearwheel set so that three holes for tightening screws are opposite threaded holes in motor housing.
15	Check valve balls	Grease check valve balls with vaseline and place one in each of the two holes.
16	End cover	Turn the end cover so that the holes line up. (Beware of the check valve balls). Use a 4 mm Allan key.
18	Washer	
19	Screws	Fit loosely the three screws with new washers. Tight the screws.  Tightening torque: 7.5 - 9.5 N•m [66 - 84 lbf•in]
17	Seal plugs	Fit in seal plugs.

Chapter

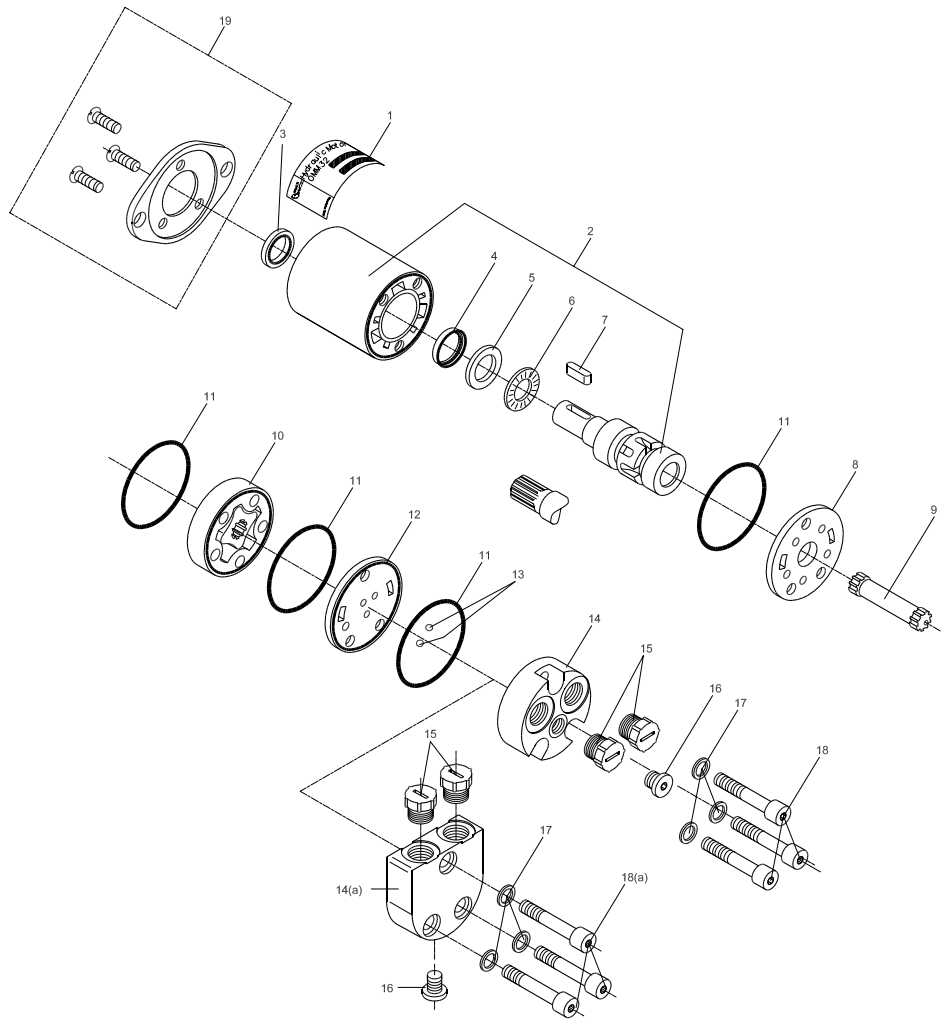
6

OMM

Topics:

- *Exploded view*
 - *Spare Parts OMM*
-

Exploded view



151-1007.19 - 17

Tightening torque:

item 16 10 - 15 N•m [88 - 133 lbf•in]

item 18 22 - 28 N•m [195 - 248 lbf•in]

Spare Parts OMM

Item	Spare Part	Dimensions	Code no.	Number per motor
1	Label			
2	Housing and output shaft	not sold separately		
3*	Dust seal ring	17 • 23 • 5.0 mm	633B3373	1
4*	Shaft seal BAKHD NBR	28 • 17 • 5.5 mm	633B3208	1

Item	Spare Part	Dimensions	Code no.	Number per motor
4	Shaft seal BAHD FPM	28 • 17 • 5.5 mm	633B3390	1
5	Bearing race	27.8 • 17.1 • 3.0 mm	151G0307	1
6	Needle bearing	28.3 • 17.1 • 2.0 mm	981X3172	1
7	Parallel key, metric version	16 • 5.0 • 5.0 mm DIN 6885	682L8026	1
	Parallel key, SAE version	3/16 • 3/16 • 3/4 inch B.S. 46	682L8031	1
8	Distributor plate	60 • 16 • 5.0	151G0314	1
9	Cardan shaft OMM 8/10	l = 54.0 mm	151G0369	1
	Cardan shaft OMM 12.5	l = 56.0 mm	151G0309	1
	Cardan shaft OMM 20	l = 59.0 mm	151G0310	1
	Cardan shaft OMM 32/50	l = 64.0 mm	151G0311	1
	Cardan shaft OMM 70	l = 80.2 mm	151G0483	1
10	Gearwheel set OMM 8	w = 3.5 mm	151G0119	1
	Gearwheel set OMM 10	w = 4.2 mm	151G0135	1
	Gearwheel set OMM 12.5	w = 5.52 mm	151G0101	1
	Gearwheel set OMM 20	w = 8.5 mm	151G0102	1
	Gearwheel set OMM 32	W = 13.5 mm	151G0103	1
	Gearwheel set OMM 50	W = 21.5 mm	151G0117	1
	Gearwheel set OMM 70	w = 29.9 mm	151G0136	1
11*	O-ring	54 • 1.5 mm	633B1487	4
12	Intermediate plate	60 • 5.0 mm	151G0332	1
13	Check valve	4.76	689X1005	2
14	End cover, metric versionend port	G 3/8 in ports	151G0113	1
	End cover, SAE versionend port	9/16 - 18 UNF	151G0114	1
14a	End cover, metric versionside port	G 3/8 in ports	151G0109	1
	End cover, SAE versionside port	9/16 - 18 UNF	151G0110	1

Item	Spare Part	Dimensions	Code no.	Number per motor
15	Seal plug, metric version	G 3/8 in	633X7009	2
	Seal plug, SAE version	9/16 - 18 UNF	633X7023	2
16	Drain plug, metric version	G 1/8 in	631X2053	1
	Drain plug, SAE version	3/8 - 24 UNF	151G0111	1
17*	Washer	8.2 • 11.9 • 1.0 mm	684X2481	3
18	Screw M8 • 1.25 - end port motor			
	OMM 8/10 and 12.5	l = 40 mm	681X0358	3
	OMM 20	l = 45 mm	681X0359	3
	OMM 32	l = 50 mm	681X0360	3
	OMM 50	l = 55 mm	681X0324	3
18a	Screw M8 • 1.25 - side port motor			
	OMM 8/10/ and 12.5	l = 45 mm	681X0359	3
	OMM 20	l = 50 mm	681X0360	3
	OMM 32	l = 55 mm	681X0324	3
	OMM 50	l = 60 mm	681X0098	3
	OMM 70	l = 70 mm	681X1523	3
19	Mounting flange with screws, metric version only		151G0211	1
Set of Seals				
Seal kit OMM incl.- items 3, 4, 11 and 17			151G0202	

Chapter






7

Dismantling OMM / Cleaning

Topics:

- *Dismantling*
 - *Cleaning*
-

Dismantling

Item	Part to Remove	Comments
7	Parallel key	Remove parallel key
15	Seal plugs	Put the motor in a holding tool with the output shaft lowest and remove the seal plugs.
19	Drain plug	Use a 5 mm Allan key.
18	Screws	Use a 6 mm Allan key.
14	End cover	
13	Balls	Remove end cover sideways. Beware of the two check valve.
11	O-ring	Remove intermediate plate + O-ring. 
12	Intermediate plate	
10	Gearwheel set	Hold fingers under the gearwheel set to prevent the gear from dropping out.
11	O-rings	
9	Cardan shaft	Remove cardan shaft.
8	Distributor plate	Remove distributor plate.
11	O-ring	
	Output shaft	Take output shaft out of housing.
5	Bearing race	
6	Needle bearing	Remove needle bearing and bearing race.
3	Dust ring	Remove dust seal by means of a screwdriver. 
4	Shaft seal	Remove shaft seal by means of a screwdriver 

Cleaning

Cleaning

Clean all parts carefully with low aromatic kerosine.

Inspection and replacement

Check all parts carefully and replace if necessary.

Lubrication

Before assembly, lubricate all parts with hydraulic oil and grease rubber parts with vaseline.

Chapter

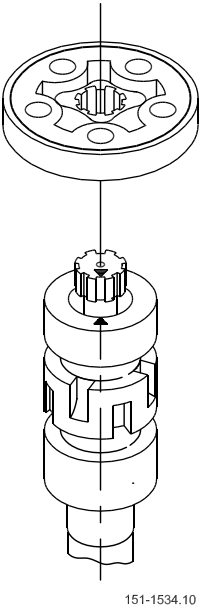

8



Assembly OMM

Topics:

- *Assembly*
-

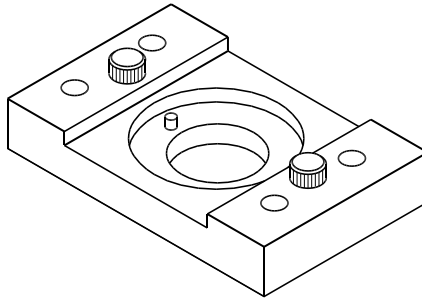
Assembly

Item	Part to Install	Comments
4	Shaft seal	Fit shaft seal in motor housing by means of mandrel and plastiv hammer.
3	Dust seal	Fit dust seal in motor housing by means of mandrel and plastiv hammer.
5	Bearing race	Fit needle bearing and bearing race to shaft.
6	Needle bearing	Fit needle bearing and bearing race to shaft.
	 <p>151-1534.10</p>	<p>Mark output shaft at middle of two commutating grooves. Install shaft in motor housing.  See drawing 151-1534.10</p>
	Figure 2: Output shaft	
7	Key	Fit key in output shaft. Place motor housing with shaft in holding tool.
11	O-ring	Grease the O-ring and put in the O-ring groove of the housing.
9	Cardan shaft	Guide the cardan shaft down into the output shaft. Place the forc (tool) under the upper cardan shaft teeth. Transfer the mark from output shaft to cardan shaft. See drawing 151-1534.10
11	O-ring	Grease the O-ring and put in the O-ring groove of the housing.
8	Distributor plate	Turn the distributor plate so that the holes line up.
10	Gearwheel set rim	Place gearwheel set on cardan shaft so that the mark on the cardan shaft is opposite a tooth peak on the external tothing of the gearwheel. Turn the tooth rim till holes for screws line up- See drawing 151-1534.10.
11	O-ring	Grease the O-ring and put in the O-ring groove of the housing.

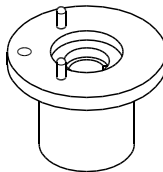
Item	Part to Install	Comments
12	Intermediate plate	Place the intermediate plate on gearwheel set so that three holes for tightening screws line up.
13	Check valve balls	Lubricate the check valve balls and place them in the holes in the intermediate plate.
14	End cover	Turn the end cover so that the holes line up. (Beware of the check valve balls).
17	Washer	
18	Screws	Fit loosely the three screws with new washers. Tight the screws.  Tightening torque: 22 - 28 Nm. [195 • 248 lbf•in]
15	Seal plugs	Fit in seal plugs.
16	Drain plug	Fit in drain plug and tight it.  Tightening torque: 10 - 15 Nm. [88 - 133 lbf•in]

Chapter 9

Tools

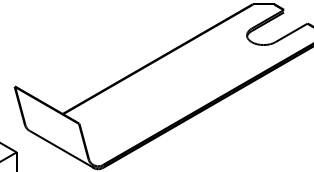


**Figure 3: Main holding tool:
Code number: SJ150-9000-2**



151-1539.10

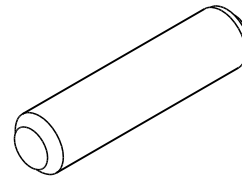
**Figure 5: Bush for use with
main holding tool: Code
number: SJ151G9000-2**



151-1538.10

**Figure 4: Fork. For use when
fitting OMM cardan shaft.**

151-1537.10 **Code number: SJ151G9000-1**



151-1540.10

**Figure 6: Mandrel for fitting
shaft seal: Code number:
SJ151G9000-5**

