

System Solutions for Towed Machines

EPOM (Externally Propelled Off-Highway Machines)



1800-OILSOL
1800-645765

<https://oilsolutions.com.au/>

sales@oilsolutions.com.au

Reference: 100-P-000145-EN-02

Contents

Page

1	General	4
1.1	Description	4
1.2	Features of the valve block	4
1.3	Data sheets for specific sections	4
1.4	Application examples	4
2	Valve overview	5
2.1	General technical data	5
2.2	Inlet sections, LVS	6
2.3	Intermediate sections, LVS	8
2.4	Adapter sections	14
2.5	Sections with seat valves for fitting after an adapter section, LVS-A-...	15
2.6	Block end sections	16
2.7	Sections to enable later extension of the block	18
2.8	Electrohydraulic steering systems with approval for on-road use	18
3	System solution EBT610	19
3.1	Hydraulic valve block with a maximum of 8 sections (+ valves for steering)	19
3.2	Control Unit EBT-610108-AS-AGRI-100034555	20
4	System solution EBT620	22
4.1	Hydraulic valve block with a maximum of 11 sections (+ valves for steering)	22
4.2	Control Unit EBT-620108-AS-AGRI-100035218	23
5	Accessories	24
5.1	Block accessories, LVS	24
5.2	Block accessories, SVH04	25
5.3	General accessories	26
5.4	EBT-6-Wiring harness, 100035336	27

1 General

1.1 Description

Bucher Hydraulics is a very capable partner for electro-hydraulic systems. Hydraulic and electronic components specially developed for use in towed machines are marked out by their reliability, despite variations in temperature, severe mechanical stresses and electromagnetic interference.

The EPOM range (Externally Propelled Off-Highway Machines) includes highly adaptable modular designs for all roles within the area of electrohydraulic system solutions for towed machines, and it reflects more than 60 years of experience in this field.

As well as customised valve block solutions, the EPOM program features two different systems as package solutions with proven, configurable components.

1.2 Features of the valve block

1.2.1 Working Δp reduced to 9 bar

A Δp of 9 bar at the hydraulic valve block in the EPOM system is sufficient to provide the maximum flow rate of 150 l/min at the actuator ports.

LVS directional valve systems from Bucher Hydraulics have a very low Δp of only 9 bar, thus helping to save energy costs.

1.2.2 Can be used with all pump systems

A manual changeover can be incorporated in the inlet section of the hydraulic valve block. This changeover enables the system to be used with fixed-delivery as well as LS pump systems.

1.2.3 Tank pressure rating up to 210 bar

All valve sections in the hydraulic valve block for EPOM systems are designed for tank pressures up to 210 bar.

1.3 Data sheets for specific sections

Bucher Hydraulics aims to provide its customers with the required technical data as quickly and specifically as possible. For this reason, individual technical data sheets have

System solution EBT610 consists of a hydraulic valve block with a maximum of 8 sections, a control unit with 7 toggle switches and a rotary potentiometer, and the wiring harness.

System solution EBT620 consists of a hydraulic valve block with a maximum of 11 sections, a control unit with 10 toggle switches and a rotary potentiometer, and the wiring harness.

Both systems can be extended for **electronic-hydraulic steering systems** with approval for use on public roads. In designing these systems, Bucher Hydraulics works closely with expert application specialists from the company MOBIL ELECTRONIK.

For further information, see 2.8

1.2.4 Load sensing pressure booster

If the Δp at the inlet of the hydraulic valve block is too low to provide the required flow rate at the actuator port, LS pressure boosters can be integrated into the system. These can be as LVS inlet section, or as a monoblock for line-mounted installation.

1.2.5 Priority function

A priority valve is not required, not even with integral steering valves. This reduces the pressure losses and the pipe-work costs.

1.2.6 The complete functionality for the application can be built into one valve block

Thanks to the valve functions, which are optimised for individual actuators, and to the downstream pressure compensators, all the functions required for the application can be integrated into one valve block, combined just as required. The result is an ideal system solution.

been prepared for the valves listed in the tables below. Please refer to the data sheet numbers listed in the tables.

1.4 Application examples



2 Valve overview

The highly adaptable modular EPOM system offers a variety of ways to build the best electrohydraulic control solution for your towed machine.

For this reason, the following valve overview also includes

components that are not scheduled in the standardised EBT610 and EBT620 system solutions. Our system specialists will be glad to advise you on using these, and other, components.

2.1 General technical data

General characteristics	Unit	Description, value
Fluid temperature	°C	-30 ... +80
Viscosity range	mm ² /s	For reliable operation 380 ... 10 For rated performance 80 ... 20
Minimum fluid cleanliness level		ISO 4406 code 20/18/15
Pressure	bar	LVS08: pump port max. 250, actuator port max. 280, tank port max. 200 static LVS12: pump port max. 350, actuator port max. 400, tank port max. 200 static
Flow rate	l/min	Maximum flow at the P inlet = 200 Maximum flow at the actuator ports A + B = LVS08 = 45 with control Δp of 9 bar LVS12 = 150 with control Δp of 9 bar
Current and voltage		LVS08: ON/OFF solenoid 30 W, proportional solenoid 12 V DC / 2.5 A, 24 V DC / 1.25 A at maximum stroke. LVS12 electrohydraulic: 12 V DC / 1.5 A, 24 V DC / 0.75 A at maximum stroke.
Onboard voltage	V DC	Minimum required for ON/OFF solenoids: 10.8 / 21.6 at the coil plug contacts
Hydraulic fluid		Recommendation: high-quality fluids with a mineral-oil base, such as HLP oils to DIN 51524 part 2. For other fluids (e.g. phosphate esters) please contact Bucher Hydraulics.

2.2 Inlet sections, LVS

$P_{max} = 350 \text{ bar} / Q_{Nom} = 200 \text{ l/min} / Q_{A+B \text{ to } T} = 240 \text{ l/min} / \Delta p = 9 \text{ bar}$

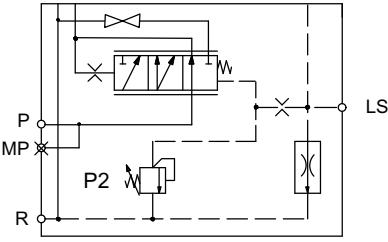
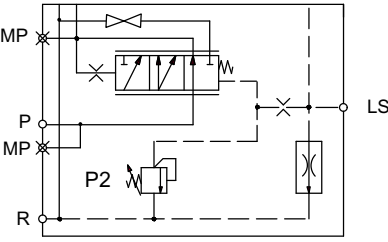
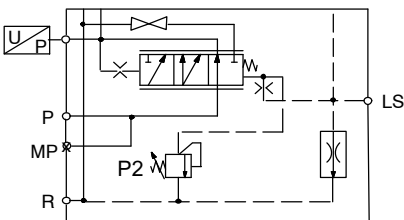
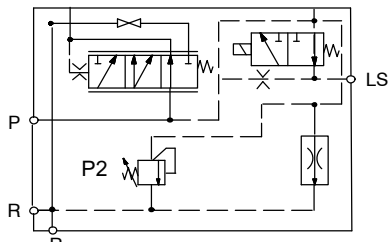
Symbol	Description	Data sheet	Part number
	Position in the control block		
	<p>LVS-E-CME-G110B12/P2=</p> <ul style="list-style-type: none"> Manual changeover between open centre (3 way pressure compensator) and closed centre (2 way pressure compensator) Load-sensing system can be unloaded LS_{max} pressure control, priority flow, $P2 =$ Port threads: P and R = G1", MP and LS = G1/4" MP test port = G1/4" plugged Valve width 75 mm, screw-in depth for tie bolt 15 mm <p>⇒ pressure setting P2 in bar is required for ordering, $P = P2 (LS_{max}) + \Delta p$</p>	100-P-000129	100032933
	<p>LVS-E-CME-G110B51/P2=</p> <ul style="list-style-type: none"> Manual changeover between open centre (3 way pressure compensator) and closed centre (2 way pressure compensator) Load-sensing system can be unloaded LS_{max} pressure control, priority flow, $P2 =$ Port threads: P and R = G1", MP and LS = G1/4" MP test port before the pressure compensator = G1/4" plugged MP test port after the pressure compensator = M12x1,5 plugged Valve width 75 mm, screw-in depth for tie bolt 15 mm <p>⇒ pressure setting P2 in bar is required for ordering, $P = P2 (LS_{max}) + \Delta p$</p>	100-P-000147	100033315
	<p>LVS-E-CME-G110B90/P2=</p> <ul style="list-style-type: none"> Manual changeover between open centre (3 way pressure compensator) and closed centre (2 way pressure compensator) Load-sensing system can be unloaded LS_{max} pressure control, priority flow, $P2 =$ Pressure switch (7 bar) for Enable signal when pressure is available (ex. for steering valves) Port threads: P and R = G1", MP and LS = G1/4" MP test port = G1/4" plugged Valve width 75 mm, screw-in depth for tie bolt 15 mm <p>⇒ pressure setting P2 in bar is required for ordering, $P = P2 (LS_{max}) + \Delta p$</p>	100-P-000176	100036753
	<p>LVS-E-CME-G110J12B103/P2=</p> <ul style="list-style-type: none"> Manual changeover between open centre (3 way pressure compensator) and closed centre (2 way pressure compensator) Load-sensing system can be unloaded LS_{max} pressure control, priority flow, $P2 =$ Integral load sensing pressure booster Port threads: P and R = G1", LS = G1/4", second R = G1/4" Valve width 97 mm, screw-in depth for tie bolt 15 mm <p>⇒ pressure setting P2 in bar is required for ordering, $P = P2 (LS_{max}) + \Delta p$</p>	100-P-000178	100038136

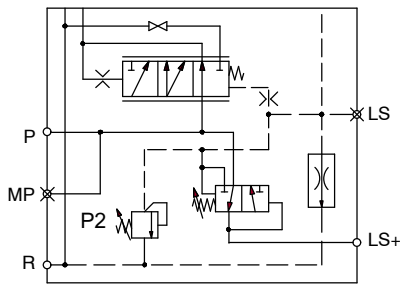

LVS-E-CME-G110B109/P2=

100040129

- Manual changeover between open centre (3 way pressure compensator) and closed centre (2 way pressure compensator)
 - Load-sensing system can be unloaded
 - LS_{max} pressure control, priority flow, $P2 =$
 - Integral load sensing pressure booster, pressure increase max. 8 bar (factory setting = 6 bar)
 - Port threads: P and R = G1", LS = G1/4", MP test port = G1/4" plugged
 - Valve width 75 mm, screw-in depth for tie bolt 15 mm
- ⇒ pressure setting P2 in bar is required for ordering, $P = P2 (LS_{max}) + \Delta p$

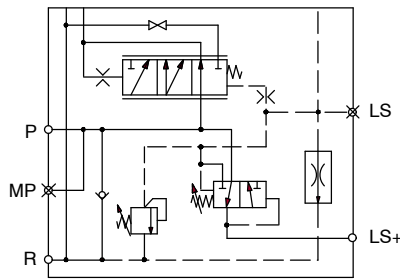

LVS-E-CME-G110B114/P2=

100040710

- Manual changeover between open centre (3 way pressure compensator) and closed centre (2 way pressure compensator)
 - Load-sensing system can be unloaded
 - LS_{max} pressure control, priority flow, $P2 =$
 - Integral load sensing pressure booster, pressure increase max. 8 bar (factory setting = 6 bar)
 - With a check valve between R and P to prevent unacceptable pressures in R in the case where the tank line is not connected, in conjunction with cylinder functions (pressure intensification).
 - Port threads: P and R = G1", LS = G1/4", MP test port = G1/4" plugged
 - Valve width 75 mm, screw-in depth for tie bolt 15 mm
- ⇒ pressure setting P2 in bar is required for ordering, $P = P2 (LS_{max}) + \Delta p$

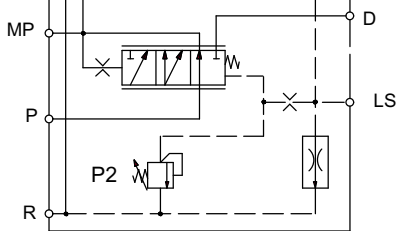

LVS-E-CME-G101A54/P2=

100-P-000130

100032775

Note:

- Test port for priority flow

- Internal priority flow
 - Load-sensing system can be unloaded
 - LS_{max} pressure relief of priority flow, $P2 =$
 - Q_{in} up to 200 l/min, surplus flow at port D = 200 l/min
 - Port threads: P and R = G1", MP and LS = G1/4"
 - Valve width 97 mm, screw-in depth for tie bolt 15 mm
- ⇒ pressure setting P2 in bar is required for ordering, $P = P2 (LS_{max}) + \Delta p$
- Priority function:**
The LVS valve sections mounted after the inlet section are given priority supply. The maximum pressure for the priority flow is set using P2. The surplus flow is available at port D.

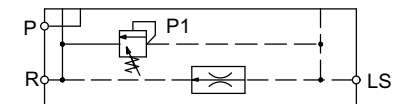

LVS-E-CE*-G110A01/P1=

100-P-000177

100029646

- Load-sensing system can be unloaded
- LS_{max} pressure relief is adjustable
- Port threads: P and R = G1", LS = G1/4"
- Valve width 66 mm, screw-in depth for tie bolt 15 mm

2.3 Intermediate sections, LVS

2.3.1 Directional valve section LVS08

Max. inlet pressure = 250 bar / max. flow rate = 45 l/min at Δp 9 bar

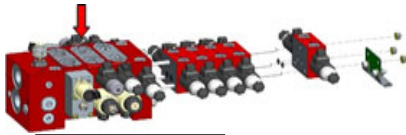
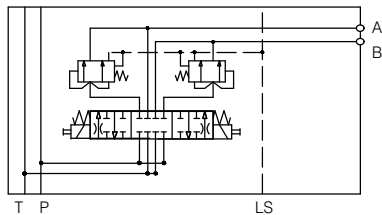
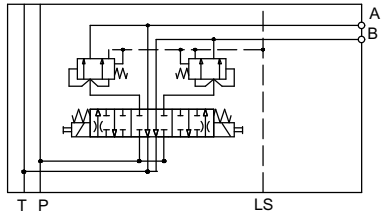
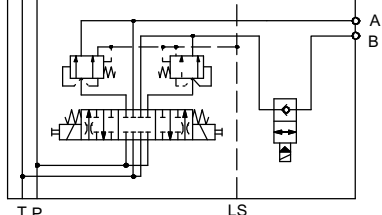
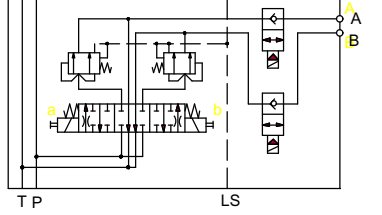
Symbol	Description	Data sheet	Part number
	Position in the control block		
	LVS08PP4A5AJ21A0000C	100-P-000136	100033685
	<ul style="list-style-type: none"> • ON/OFF solenoid with emergency pin, 12 V DC, AMP-Junior Timer • Q_{max} at ports A and B = 45 l/min at Δp 9 bar • Max. leakage at ports A and B at 100 bar = 50 cm³/min • Center position closed to tank (spool type 4A) • Pressure compensator function in actuator ports A and B • Port thread for actuator A and B = G1/2" • Valve width 48 mm 		
	LVS08PP4D5AJ21A0000C	100-P-000137	100033686
	<ul style="list-style-type: none"> • ON/OFF solenoid with emergency pin, 12 V DC, AMP-Junior Timer • Q_{max} at ports A and B = 45 l/min at Δp 9 bar • Ports A and B connected to tank in neutral position • Center position open to tank (spool type 4D) • Pressure compensator function in actuator ports A and B • Port thread for actuator A and B = G1/2" • Valve width 48 mm 		
	LVS08PP4A5AJ20A0050C-J1*	100-P-000138	100033625
	<ul style="list-style-type: none"> • ON/OFF solenoid with emergency pin, 12 V DC, AMP-Junior Timer • Q_{max} at ports A and B = 45 l/min at Δp 9 bar • Max. leakage at port A at 100 bar = 50 cm³/min, port B = seat valve < 0.5 ml/min • Center position closed to tank (spool type 4A) • Pressure compensator function in actuator ports A and B • ON/OFF switchable single-seat valve in port B, de-energised closed, 17 watts • Port thread for actuator A and B = G3/8" • Valve width 48 mm 		
	LVS08PP4D5AJ20A0050C-J2*	100-P-000139	100033148
	<ul style="list-style-type: none"> • ON/OFF solenoid with emergency pin, 12 V DC, AMP-Junior Timer • Q_{max} at ports A and B = 45 l/min at Δp 9 bar • Max. leakage at ports A and B at 100 bar = seat valve < 0.5 ml/min • Center position open to tank (spool type 4D) • Pressure compensator function in actuator ports A and B • ON/OFF switchable single-seat valve in ports A and B, de-energised closed, 17 watts • Port thread for actuator A and B = G3/8" • Valve width 48 mm 		

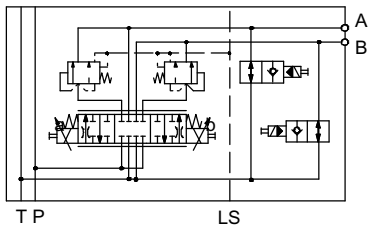

Steering, trailing axle

LVS08DD4A5CJ20A0049C-J2L	100-P-000140	100033344
--------------------------	--------------	-----------

- ON/OFF solenoid, 12 V DC, AMP-Junior Timer, with manual override (lockable using a tool), for switching off the float position
- Q_{max} at ports A and B = 22 l/min at Δp 9 bar
- Max. leakage at ports A and B at 100 bar = 50 cm³/min
- Center position closed to tank (spool type 4A)
- Self-compensating spool at different tank loads
- Pressure compensator function in actuator ports A and B
- Float position function
- ON/OFF switchable single-seat valve, ports A and B to tank, de-energised open, 17 watts, with locking screw, covered with cap nut
- Port thread for actuator A and B = G3/8"
- Valve width 48 mm

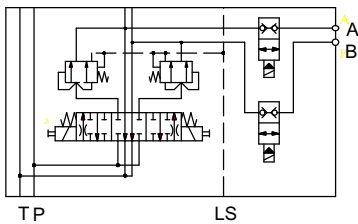

Preselector valve

LVS08DD4D5AJ20A0058C-J6D	100-P-000141	100033620
--------------------------	--------------	-----------

- ON/OFF solenoid with emergency pin, 12 V DC, AMP-Junior Timer, lockable manual override for seat valves
- Q_{max} at ports A and B = 22 l/min at Δp 9 bar
- Max. leakage at ports A and B at 100 bar = seat valve < 0.5 ml/min
- Center position open to tank (spool type 4D)
- Pressure compensator function in actuator ports A and B
- ON/OFF switchable double-seat valve in ports A and B, de-energised closed, 22 watts, manual override with star grip
- Port thread for actuator A and B = G3/8" (altered position)
- Valve width 48 mm

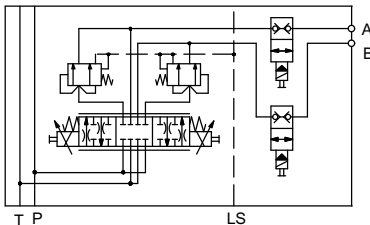

Steering, leading axle

LVS08CC4A5CJ20A0050C-J6A	100-P-000135	100033626
--------------------------	--------------	-----------

- Proportional solenoid with emergency pin, 12 V DC, AMP-Junior Timer
- Q_{max} at ports A and B = 14 l/min at Δp 9 bar
- Max. leakage at ports A and B at 100 bar = seat valve < 0.5 ml/min
- Center position closed to tank (spool type 4A)
- Self-compensating spool at different tank loads
- Pressure compensator function in actuator ports A and B
- ON/OFF switchable double-seat valve in ports A and B, de-energised closed, 17 watts, with manual override (lockable using a tool), covered with cap nut
- Port thread for actuator A and B = G3/8"
- Valve width 48 mm

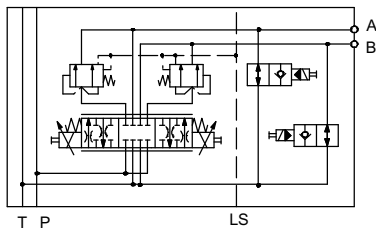

Steering, trailing axle

LVS08CC4A5CJ20A0049C-J2L	100-P-000150	100033623
--------------------------	--------------	-----------

- ON/OFF solenoid, 12 V DC, AMP-Junior Timer, with manual override (lockable using a tool), for switching off the float position
- Q_{max} at ports A and B = 14 l/min at Δp 9 bar
- Max. leakage at ports A and B at 100 bar = 50 cm³/min
- Center position closed to tank (spool type 4A)
- Self-compensating spool at different tank loads
- Pressure compensator function in actuator ports A and B
- Flat position function
- ON/OFF switchable single-seat valves for ports A and B to tank, de-energised open, 17 watts, with locking screw, covered with cap nut
- Port thread for actuator A and B = G3/8"
- Valve width 48 mm

2.3.2 Directional valve sections, LVS12

Maximum inlet pressure = 350 bar / Max. Flow rate = 180 l/min at Δp 9 bar

Symbol	Description	Data sheet	Part number
	Position in the control block		
	<p>LVS12*K3J4TJ22C1005B</p> <ul style="list-style-type: none"> • Electrohydraulic two stage, 12 V DC, AMP-Junior Timer • Emergency pin and spool-stroke limiter • Q_{max} at port B = 85 l/min at Δp 9 bar • Port B connected to tank in neutral position • 4/2 directional control valve (Spool type 3J) • Pressure compensator function for actuator B • Port thread for actuator B = G3/4" • Valve width 48 mm 	100-P-000131	100038751
	<p>LVS12KK6D5TJ22A1005B</p> <ul style="list-style-type: none"> • Electrohydraulic two stage, 12 V DC, AMP-Junior Timer • Emergency pin • Q_{max} at ports A and B = 85 l/min at Δp 9 bar • Ports A and B connected to tank in neutral position • Two 4/2 way spools in one housing (spool type 6D) • Pressure compensator function in actuator ports A and B • Port thread for actuator A and B = G3/4" • Valve width 48 mm • Application: For two single-acting actuators 	100-P-000148	100038752

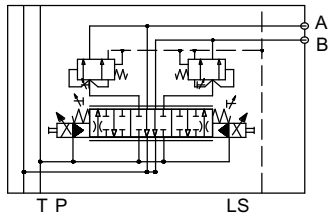

LVS12OO4D5TJ22C1005B	100-P-000132	100038753
-----------------------------	--------------	-----------

- Electrohydraulic two stage, 12 V DC, AMP-Junior Timer
- Emergency pin and spool-stroke limiter
- Q_{max} at ports A and B = 150 l/min at Δp 9 bar
- Ports A and B connected to tank in neutral position
- Center position open to tank (spool type 4D)
- Pressure compensator function in actuator ports A and B
- Port thread for actuator A and B = G3/4"
- Valve width 48 mm

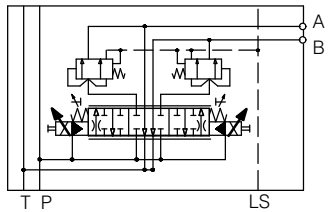

LVS12PL4D5TJ22C1005B	100-P-000134	100038087
-----------------------------	--------------	-----------

- Electrohydraulic two stage, 12 V DC, AMP-Junior Timer
- Emergency pin and spool-stroke limiter
- Q_{max} at port A = 42 and B = 106 l/min at Δp 9 bar
- Ports A and B connected to tank in neutral position
- Center position open to tank (spool type 4D)
- Pressure compensator function in actuator ports A and B
- Port thread for actuator A and B = G3/4"
- Valve width 48 mm

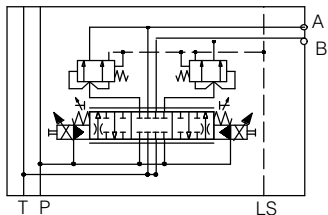

LVS12HH4A5TJ22C1005B	100-P-000133	100038088
-----------------------------	--------------	-----------

- Electrohydraulic two stage, 12 V DC, AMP-Junior Timer
- Emergency pin and spool-stroke limiter
- Q_{max} at ports A and B = 68 l/min at Δp 9 bar
- Center position closed to tank (spool type 4A)
- Pressure compensator function in actuator ports A and B
- Port thread for actuator A and B = G3/4"
- Valve width 48 mm

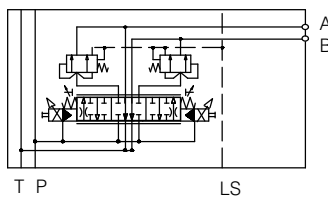

LVS12LG4D5TJ22C1005B	100-P-000206	100038089
-----------------------------	--------------	-----------

- Electrohydraulic two stage, 12 V DC, AMP-Junior Timer
- Emergency pin and spool-stroke limiter
- Q_{max} at port A = 106 and B = 54 l/min at Δp 9 bar
- Spool type 4D (with spool-stroke limiter)
- Center position open to tank (spool type 4D)
- Pressure compensator function in actuator ports A and B
- Port thread for actuator A and B = G3/4"
- Valve width 48 mm

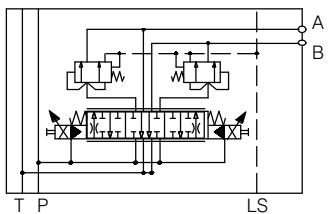

LVS12FK4D5TJ22A1005B	100-P-000149	100038628
-----------------------------	--------------	-----------

- Electrohydraulic two stage, 12 V DC, AMP-Junior Timer
- Emergency pin
- Q_{max} at port A = 32 and B = 85 l/min at Δp 9 bar
- Center position open to tank (spool type 4D)
- Pressure compensator function in actuator ports A and B
- Port thread for actuator A and B = G3/4"
- Valve width 48 mm

2.3.3 Auxiliary-function sections

Maximum inlet pressure at P = 250 bar

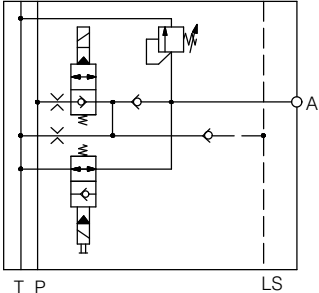
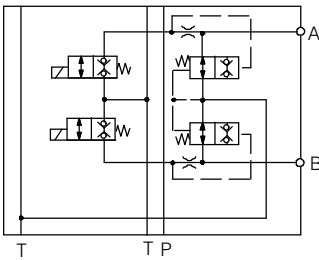
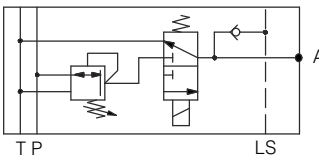
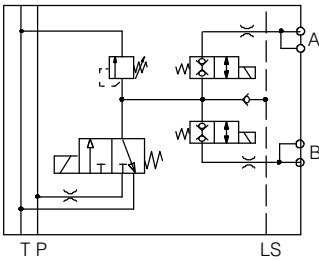
Symbol	Description	Data sheet	Part number
	Position in the control block		
	<p>LVS-Z-SA7-N-G3/4J12A00/PA=</p> <ul style="list-style-type: none"> • Q_{max} at port A = 25 l/min at Δp 9 bar • Adjustable pressure relief valve • ON/OFF switchable single-seat valve with emergency pin, 27 watts • Port thread for actuator A = G3/4" • Valve width 75 mm • Application: for single-acting actuators such as lift axles, where for safety reasons the actuator port is connected to tank in the non-operated condition. 	100-P-000152	100032516
	<p>LVS-Z-SA27-N-G1/2J12A00</p> <ul style="list-style-type: none"> • Q_{max} at ports A and B = 25 l/min at Δp 9 bar • ON/OFF switchable double-seat valve with emergency pin, 27 watts • Neutral position: float position for two single-acting cylinders, lift axle and steering axle • S1 and S2 in neutral position = float position for two single-acting cylinders • S1 and S2 energised = actuator ports A and B pressurised • Port thread for actuator A and B = G1/2" • Valve width 48 mm • Application: e.g. lift axle and steering axle 	100-P-000180	100037134
	<p>LVS-Z-SA8-N-G3/8J12A00/PA=</p> <ul style="list-style-type: none"> • Q_{max} at port A = 25 l/min at Δp 9 bar • ON/OFF switchable 3/2 directional valve • Adjustable pressure control valve • Port thread for actuator A = G3/8" • Valve width 42 mm • Application: e.g. weight transfer, top cylinder, cylinder is pressurised to load or unload the tractor front axle 	100-P-000179	100031864
	<p>LVS-Z-SA9-N-G3/8J12A00/P=</p> <ul style="list-style-type: none"> • Q_{max} at ports A and B = 25 l/min at Δp 9 bar • ON/OFF switchable 3/2 directional valve and double-seat valves • Adjustable pressure control valve for controlling the pressures that are dependent on the load • Orifices in actuator ports A and B for influencing the unloading speed • Port thread for actuator A and B = G3/8" • Valve width 66 mm • Application: e.g. running gears or axle suspensions in which hydraulic accumulators are arranged parallel to the corresponding cylinders. 	100-P-000153	100032517

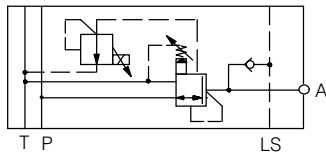

LVS-Z-SA29-G3/4I12A00/P=	100-P-000181	100037843
--------------------------	--------------	-----------

- Q_{max} at port A = 80 l/min at Δp 9 bar
- 3-way pressure control, proportionally adjustable
- Port thread for actuator A = G3/4"
- Valve width 48 mm
- Application: tractor hitch (contact pressing functions such as ground pressure and ploughing)

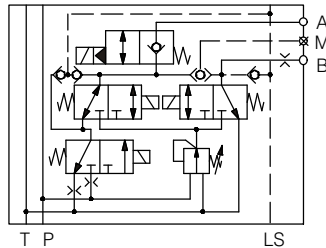

LVS-Z-SA13-G3/8J12A00/P=	100-P-000128	100034118
--------------------------	--------------	-----------

- Q_{max} at port A and B = 30 l/min at Δp 9 bar
- Pressure relief valve adjustable from 5 to 100 bar
- ON/OFF switchable 3/2 directional valve and single-seat valve, 27 watts
- Varying (+ or -) the pressure in a tractor hitch with a float position
- Pressure-controlled variation (+ or -) of the force in cylinders
- Port thread for actuator A and B = G3/8"
- Valve width 90 mm
- Application: tractor hitch
 - Leak-free lifting, lowering and holding of cylinders
 - Varying (+ or -) the pressure in a tractor hitch with a float position

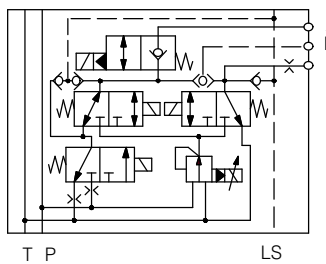

LVS-Z-SA16-G3/8J12A00/P=	100-P-000202	100034579
--------------------------	--------------	-----------

- Q_{max} at ports A and B = 30 l/min at Δp 9 bar
- Pressure reducing valve, electrically proportionally adjustable from 20 to 160 bar, 380 to 1400 mA
- ON/OFF switchable 3/2 directional valve and single-seat valve, 27 watts
- Adjustable function speed
- Switchable (on/off) pressure control for increasing/decreasing the force on implements
- Port thread for actuator A and B = G3/8"
- Valve width 90 mm
- Application: tractor hitch (3-point hydraulics)
 - Leak-free lifting, lowering and holding of cylinders
 - Pressure-controlled variation (+ or -) of the force in cylinders

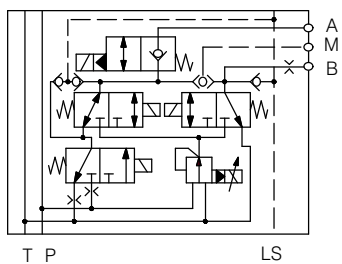

LVS-Z-SA13-G1/2-PDRA4-J12C00		100040243
------------------------------	--	-----------

- Q_{max} at ports A and B = 60 l/min at Δp 9 bar
- Pressure reducing valve, electrically proportionally adjustable from 12 to 100 bar, 380 to 1400 mA
- ON/OFF switchable 3/2 directional valve and single-seat valve, 27 watts
- Adjustable function speed
- Switchable (on/off) pressure control for increasing/decreasing the force on implements
- Port thread for actuator A and B = G3/8"
- Valve width 90 mm
- Application: tractor hitch (3-point hydraulics)
 - Leak-free lifting, lowering and holding of cylinders
 - Pressure-controlled variation (+ or -) of the force in cylinders

2.4 Adapter sections

Adapter sections are always required if SVH04 seat valves or HDS directional valves are to be fitted after LVS08 or LVS12 sections. The maximum inlet pressure at P = 250 bar

2.4.1 For fitting directional seat valves, series SVH04

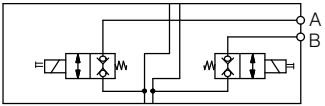
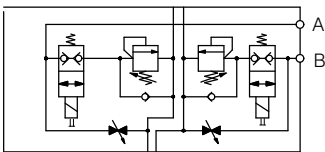
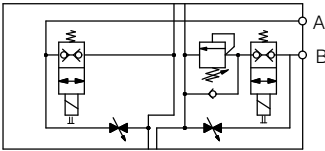
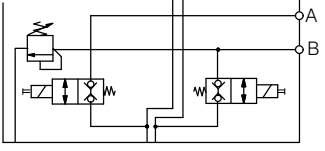
Symbol	Description	Data sheet	Part number
	Position in the control block		
			
	LVS-A-SA4-22-D-G1/4J12B06	100-P-000143	100032943
	<ul style="list-style-type: none"> • Q_{max} at ports A and B = 25 l/min • Two ON/OFF switchable double-seat valves, manual override with star grip • 12V DC, max 27 Watt • Port thread for actuator A and B= G1/4" • Valve width 39 mm • Application: interface to SVH04 directional seat valves with positioning functions 		
	LVS-A-SA4-22-D-G1/4J12B20		100033395
	<ul style="list-style-type: none"> • Q_{max} at ports A and B = 25 l/min • Two ON/OFF switchable double-seat valves, manual override with star grip • 12V DC, max 27 Watt • Adjustable pressure relief valves in the return lines of ports A and B • Port thread for actuator A and B= G1/4" • Valve width 39 mm • Application: drawbar suspension for trailers, interface to SVH04 directional seat valves 		
	LVS-A-SA6-D-G1/4J12A00	100-P-000155	100032391
	<ul style="list-style-type: none"> • Q_{max} at ports A and B = 25 l/min • Two ON/OFF switchable double-seat valves, manual override with star grip • 12V DC, max 27 Watt • Adjustable pressure relief valves in the return line of port B • Port thread for actuator A and B= G1/4" • Valve width 50 mm • Application: drawbar suspension for trailers, interface to SVH04 directional seat valves 		
	LVS-A-SA13-22-N-G1/4I12A32	100-P-000203	100036694
	<ul style="list-style-type: none"> • Q_{max} at ports A and B = 25 l/min • Two ON/OFF switchable double-seat valves, manual override with star grip • 12V DC, max 27 Watt • Adjustable pressure relief valve in port B • Port thread for actuator A and B= G1/4" • Valve width 47 mm • Application: adapter section, LVS to SVH04 		

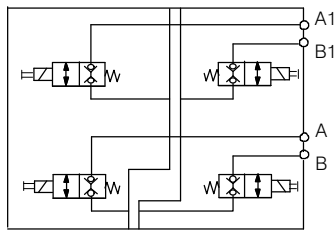

LVS-A-SA4-44-N-G1/4J12B06	100-P-000205	100037543
<ul style="list-style-type: none"> • Q_{max} at all ports = 25 l/min • Four ON/OFF switchable double-seat valves, manual override with star grip • 12V DC, max 27 Watt • Port thread for actuator A, A1, B and B1 = G1/4" • Valve width 52 mm • Application: Interface for seat valves series SVH04 		

2.4.2 For fitting directional valves, series HDS07 and HDS11

Symbol	Description	Part number
	LVS-A-SA14-****A35/Q=	100036812
<ul style="list-style-type: none"> • Q_{max} at ports A and B = 40 l/min • Maximum inlet pressure 250 bar • Increased oil flow • Application: Interface for directional valves, series HDS • Valve width 50 mm 		

2.5 Sections with seat valves for fitting after an adapter section, LVS-A-...

Maximum inlet pressure = 250 bar

Symbol	Description	Data sheet	Part number
	Position in the control block		
	SVH04Z22**D-0G14J12	100-P-000043	100030525
<ul style="list-style-type: none"> • Q_{max} at ports A and B = 25 l/min • Two ON/OFF switchable double-seat valves, manual override with star grip • 12V DC, max 27 Watt, AMP-Junior Timer with diode • Port thread for actuator A and B= G1/4" • Valve width 52 mm • Application: positioning functions requiring leak-free seating 			
	SVH04Z22**N-0G14J12	100-P-000043	100030447
<ul style="list-style-type: none"> • Q_{max} at ports A and B = 25 l/min • Two ON/OFF switchable double-seat valves, with emergency pin • 12V DC, max 27 Watt, AMP-Junior Timer with diode • Port thread for actuator A and B= G1/4" • Valve width 39 mm • Application: positioning functions requiring leak-free seating 			
	SVH04Z22**D-0G14I12	100-P-000043	100031726
<ul style="list-style-type: none"> • Q_{max} at ports A and B = 25 l/min • Two ON/OFF switchable double-seat valves, manual override with star grip • 12V DC, max 27 Watt, AMP-Junior Timer • Port thread for actuator A and B= G1/4" • Valve width 39 mm • Application: positioning functions requiring leak-free seating 			

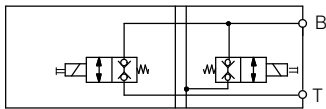

SVH04Z22**N-0G14J12/01	100-P-000043	100033601
<ul style="list-style-type: none"> • Q_{max} at actuator port B and tank port T = 25 l/min • Two ON/OFF switchable double-seat valves, with emergency pin • 12V DC, max 27 Watt, AMP-Junior Timer with diode • Float position • Port thread for actuator A and T= G1/4" • Valve width 39 mm • Application: positioning functions requiring leak-free seating 		

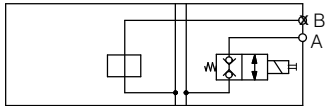

SVH04Z22**N-0G14I12	100-P-000043	100036906
<ul style="list-style-type: none"> • Q_{max} at port A = 25 l/min • 1 ON/OFF switchable double-seat valves, with emergency pin • 12V DC, max 27 Watt, AMP-Junior Timer • Port thread for actuator A = G1/4" • Valve width 39 mm • Application: positioning functions requiring leak-free seating 		

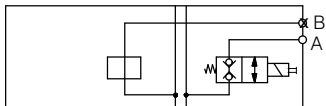

SVH04Z22**N-0G14J12	100-P-000043	100030448
<ul style="list-style-type: none"> • Q_{max} at port A = 25 l/min • 1 ON/OFF switchable double-seat valves, with emergency pin • 12V DC, max 27 Watt, AMP-Junior Timer with diode • Port thread for actuator A = G1/4" • Valve width 39 mm • Application: positioning functions requiring leak-free seating 		

2.6 Block end sections

2.6.1 End sections for SVH04 block

Maximum inlet pressure = 250 bar

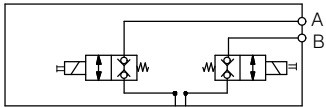
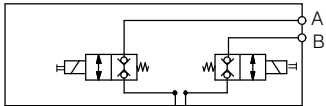
Symbol	Description	Data sheet	Part number
	Position in the control block		
	SVH04A22**D-0G14J12	100-P-000145	100030524
<ul style="list-style-type: none"> • Q_{max} at ports A and B = 25 l/min • 2 ON/OFF switchable double-seat valves, manual override with star grip • Port thread for actuator A and B = G1/4" • Valve width 39 mm • Application: positioning functions requiring leak-free seating 			
	SVH04A22**D-0G14I12	100-P-000043	100031727
<ul style="list-style-type: none"> • Q_{max} at ports A and B = 25 l/min • 2 ON/OFF switchable double-seat valves, manual override with star grip • Port thread for actuator A and B = G1/4" • Valve width 39 mm • Application: positioning functions requiring leak-free seating 			

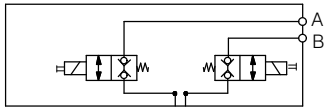

SVH04A22**N-0G14J12	100-P-000043	100031054
<ul style="list-style-type: none"> • Q_{max} at ports A and B = 25 l/min • 2 ON/OFF switchable double-seat valves with emergency pin • Port thread for actuator A and B = G1/4" • Valve width 39 mm • Application: positioning functions requiring leak-free seating 		

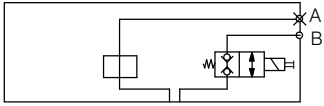

SVH04A21**D-0G14J12 X=B	100-P-000159	100032008
<ul style="list-style-type: none"> • Q_{max} at port B = 25 l/min • 1 ON/OFF switchable double-seat valves, manual override with star grip • Port thread for actuator B = G1/4" • Valve width 39 mm • Application: positioning functions requiring leak-free seating 		

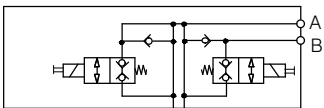

SVH04A22**N-0G14J12/26		100036102
<ul style="list-style-type: none"> • Q_{max} at ports A and B = 25 l/min • 2 ON/OFF switchable double-seat valves with emergency pin • Port thread for actuator A and B = G1/4" • Valve width 39 mm • Application: positioning functions requiring leak-free seating 		

2.6.2 End sections for LVS blocks

Symbol	Description	Data sheet	Part number
	Position in the control block		
	LVS-A-CA* .****A00	100-P-000160	100027983
	<ul style="list-style-type: none"> • No control function • Valve width 32 mm • Application: end section for LVS block 		

2.7 Sections to enable later extension of the block

2.7.1 Sections with seat valves for fitting after an adapter section, LVS-A-...

IMPORTANT!

The following segment is black anodized for retrofitting into a valve block that has already been black-primed

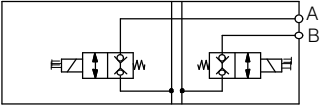
Symbol	Description	Data sheet	Part number
	Position in the control block		
	<p>SVH04A22**D-0G14J12/50</p> <ul style="list-style-type: none"> • Black anodized • Q_{max} at ports A and B = 25 l/min • 2 ON/OFF switchable double-seat valves, manual override with star grip • Port thread for actuator A and B = G1/4" • Valve width 39 mm • Application: positioning functions requiring leak-free seating 	100-P-000157	100040777

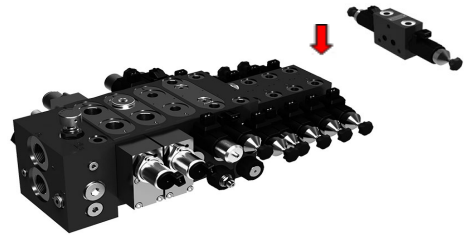

2.7.2 Black-primed sections

IMPORTANT!

The sections listed in paragraph 2.3 can be ordered as black-primed "painted blocks". Such a painted block always consists of five sections, is closed off at both block ends with a sheet metal cover and is held together with tie bolts.

Delivery: 5 sections bolted together as a painted block

Paint finish: Black-primed, RAL9004

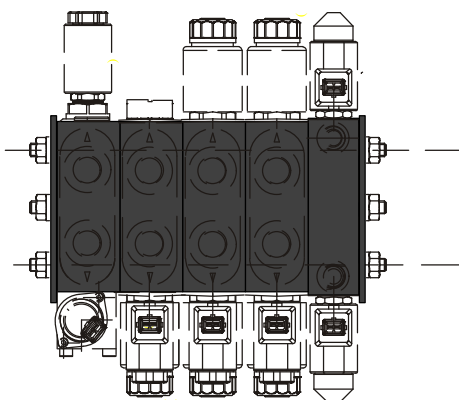

Ordering example:

1 pc painted block consisting of 5 pcs directional valve section LVS08DD4A5CJ20A0049C-J2L (100033344)

2.8 Electrohydraulic steering systems with approval for on-road use

In designing electronic-hydraulic steering systems with approval for use on public roads, Bucher Hydraulics works closely with application specialists from the company MOBIL ELECTRONIK.

MOBIL ELECTRONIK offers comprehensive system solutions for steering the rear axles of commercial vehicles and trailers, with approval for use on public roads in accordance with ECER79 together with Appendix 6. From the simple trailing axle with fail-safe operation to multiple-axis auxiliary steering systems that work in fail-operational mode, any conceivable application can be configured from a modular system with virtually unlimited combination possibilities.

For the design and layout of your steering system, please make direct contact with

MOBIL ELEKTRONIK GMBH
 Bössingerstraße 33
 74243 Langenbeutingen
Info@mobil-elektronik.com
 Tel.: +49 7946 (0)91940

3 System solution EBT610

3.1 Hydraulic valve block with a maximum of 8 sections (+ valves for steering)

Example
of block configuration

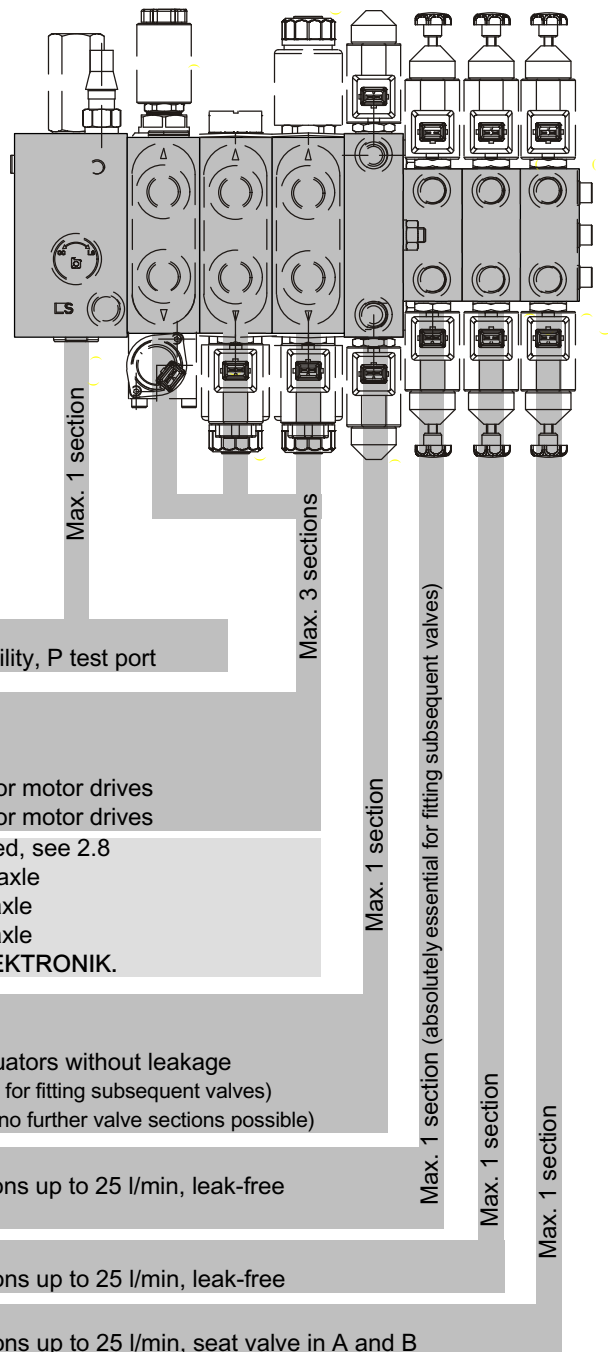

Inlet sections	Function
LVS-E-CM*_G110B12	OC/CC changeover capability, P test port

Intermediate sections	Function
1. LVS12PL4D5TJ22C1005B	Motor drives
2. LVS12HH4A5TJ22C1005B	Cylinder function or motor drives
3. LVS12HH4A5TJ22C1005B	Cylinder function or motor drives

Directional sections for steering can also be incorporated, see 2.8	
1. LVS08CC4A5CJ20A0050C-J6A	Steering, leading axle
2. LVS08DD4A5BJ20A0049C-J2N	Steering, trailing axle
3. LVS08CC4A5CJ20A0049C-J2L	Steering, trailing axle

Use these valves only after discussion with MOBIL ELEKTRONIK.

Preselector valve or end section	Function
LVS08DD4D5AJ20A0058C	Holding small actuators without leakage (absolutely essential for fitting subsequent valves)
LVS-A-CA*-****A00	LVS end section (no further valve sections possible)

Adapter plates	Function
LVS-A-SA4-22-D-G1/4J12B06	Positioning functions up to 25 l/min, leak-free

Intermediate sections + seat valves	Function
SVH04Z22**D-0G14J12	Positioning functions up to 25 l/min, leak-free

End sections with seat valves	Function
SVH04A21**D-0G14J12	Positioning functions up to 25 l/min, seat valve in A and B

IMPORTANT!:
Block accessories as per Sections 9.1 and 9.2 must also be ordered when ordering a valve block.

3.2 Control Unit EBT-610108-AS-AGRI-100034555

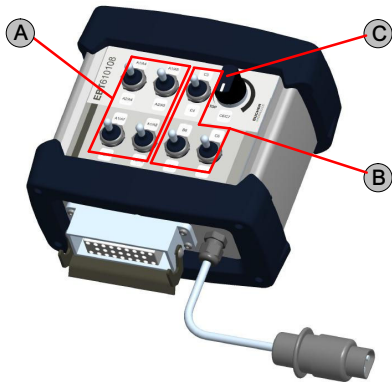

Item	Switch types
A	Momentary ON-OFF-ON toggle switch, (4 pcs.)
B	Detenting ON-OFF-ON toggle switch (3 pcs.)
C	Rotary potentiometer with On/Off switch

For more information see data sheet 100-P-000163

3.2.1 General Data

Electrical characteristics	Unit	Description, value
Supply voltage	V	12 ... 30 smoothed DC. Ripple < 10%
Total current consumption	A	≤ 18
Number of electrical power outputs		$\eta_{prop} = 2$ $\eta_{on/off} = 10$
Number of hydraulic operating positions (with LVS valve block)		$\eta_{prop} = 2$ $\eta_{on/off} = 12$
Adjustable minimum current	A	$I_{min} = 0,2 \dots 1,2$
Adjustable maximum current	A	$I_{max} = I_{min} + 0,4 \dots 2,5$
Maximum permissible output current	A	$I_{max} = 2,5$
Dither frequency	Hz	100
Protection class		IP65
Operating temperature	°C	-25 ... +70
Dimensions W / L / H	mm	176 / 174 / 106
Weight	kg	1,91
Connection type HAN 25D		25-pin

3.2.2 Symbols on the operating interface (available symbols, see 3.2.3)

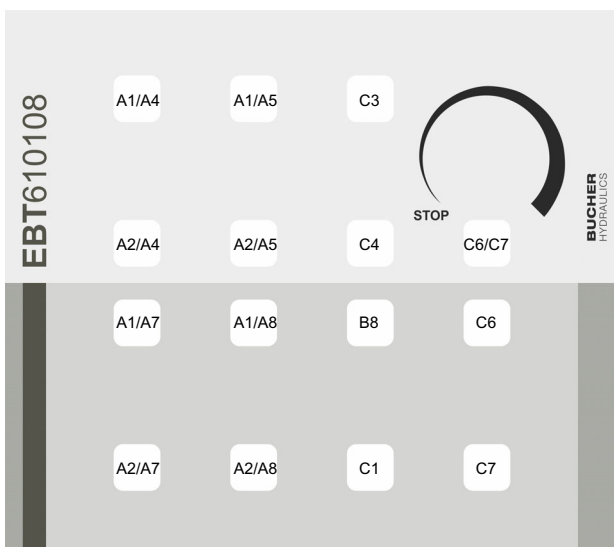

IMPORTANT!:

For quantities <10 pieces per lot size, the symbols will be supplied in the form of weather- and UV-resistant adhesive labels. Customised membranes, front panels with sub-surface printing on anodised aluminium, and variations of the configuration can be supplied from 10 pieces at extra cost.

3.2.3 Deliverable symbols

No.	Symbol	Description	No.	Symbol	Description	No.	Symbol	Description
1		Drawbar, raise	25		Boom, unfold	49		Automatic field mode, on
2		Drawbar, lower	26		Boom, fold	50		Automatic field mode, off
3		Undercarriage, raise	27		Precision distributor, on (preferred direction)	51		Automatic spreading mode, on
4		Undercarriage, lower	28		Precision distributor, on (reverse operation)	52		Automatic spreading mode, off
5		Lift axle, raise	29		Precision distributor, off	53		Scraper floor, on (preferred direction)
6		Lift axle, lower	30		Drip stop, on	54		Scraper floor, on (reverse operation)
7		Steering, lock	31		Drip stop, off	55		Gate valve, raise
8		Steering, unlock	32		Attachment, raise	56		Gate valve, lower
9		Support leg, raise	33		Attachment, lower	57		Tailgate, open
10		Support leg, lower	34		Attachment, press down	58		Tailgate, close
11		Tyre pressure, increase	35		Attachment, counterbalance	59		Boundary spreading, ON
12		Tyre pressure, decrease	36		Attachment, float	60		Boundary spreading, OFF
13		Macerator, ON (preferred direction)	37		Pump, ON	61		Spreading rate, speed-dependent
14		Macerator, ON (reverse operation)	38		Pump, OFF	62		Spreading rate, manual
15		Macerator, OFF	39		Suction boom, swing right	63		Scraper floor speed
16		Filling accelerator, ON	40		Suction boom, swing left	64		Switch unit ON
17		Filling accelerator, OFF	41		Suction boom, raise	65		Switch unit OFF
18		Suction valve, open	42		Suction boom, lower	66		Pickup, raise
19		Suction valve, close	43		Suction boom, fold out	67		Pickup, lower
20		Three-way valve, spreading mode	44		Suction boom, fold in	68		Oil pressure, steering
21		Three-way valve, filling mode	45		Automatic filling mode, ON	69		Error message, steering
22		Three-way valve, agitation mode	46		Automatic filling mode, OFF	70		Automatic speed monitoring
23		Suction arm, swing out	47		Automatic road mode, ON	71		Cutter, retract
24		Suction arm, swing in	48		Automatic road mode, OFF	72		Cutter, extend

3.2.4 Ordering code

Description	Ordering code	Part number
Control unit for towed machines	EBT-6100108-AS-AGRI-100034555	100034555

4 System solution EBT620

4.1 Hydraulic valve block with a maximum of 11 sections (+ valves for steering)

Example of block configuration

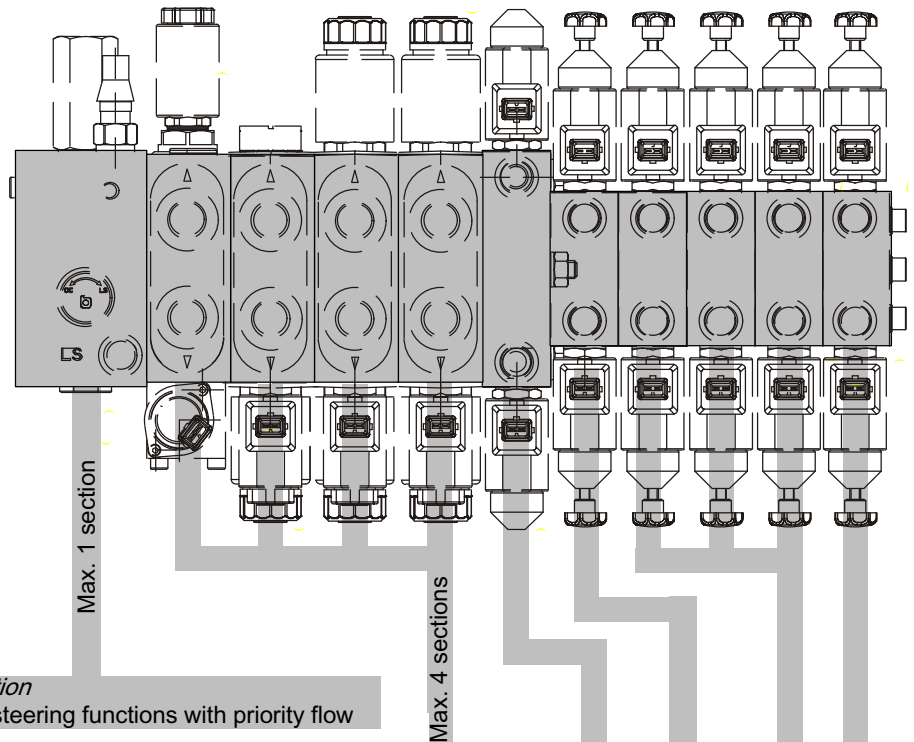

Inlet sections	Function
LVS-E-CME_G101A54	Axle/steering functions with priority flow

Intermediate sections	Function
1. LVS12PL4D5TJ22C1005B	Motor drives
2. LVS12PL4D5TJ22C1005B	Motor drives
3. LVS12HH4A5TJ22C1005B	Cylinder function or motor drives
4. LVS12HH4A5TJ22C1005B	Cylinder function or motor drives

Directional sections for steering can also be incorporated, see Sect. 2.8	Function
1. LVS08CC4A5CJ20A0050C-J6A	Steering, leading axle
2. LVS08DD4A5BJ20A0049C-J2N	Steering, trailing axle
3. LVS08CC4A5CJ20A0049C-J2L	Steering, trailing axle
4. LVS08DD4A5BJ20A0049C-J2N	Steering, trailing axle

Use these valves only after discussion with MOBIL ELEKTRONIK.

Preselector valve or end section	Function
LVS08DD4D5AJ20A0058C	Holding small actuators without leakage (absolutely essential for fitting subsequent valves)
LVS-A-CA*..****A00	LVS end section (no further valve sections possible)

Adapter sections	Function
LVS-A-SA4-22-D-G1/4J12B06	Positioning functions up to 25 l/min, leak-free

Intermediate sections / seat valves	Function
1. SVH04Z22**D-0G14J12	Positioning functions up to 25 l/min, leak-free
2. SVH04Z22**D-0G14J12	Positioning functions up to 25 l/min, leak-free
3. SVH04Z22**D-0G14J12	Positioning functions up to 25 l/min, leak-free

End sections with seat valves	Function
SVH04A22**D-0G14J12	Positioning functions up to 25 l/min, seat valve in B

IMPORTANT!:
Block accessories as per Sections 9.1 and 9.2 must also be ordered when ordering a valve block

4.2 Control Unit EBT-620108-AS-AGRI-100035218

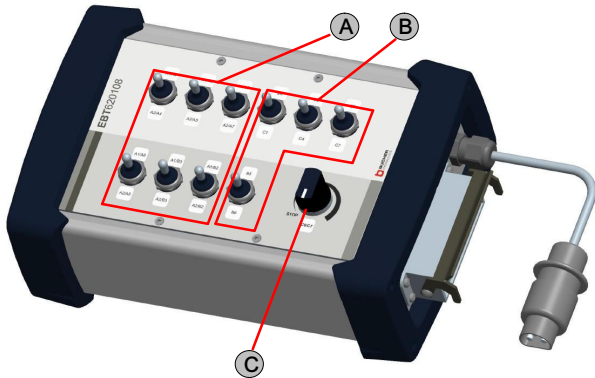

Item	Switch types
A	Momentary ON-OFF-ON toggle switch (6 pcs.)
B	Detenting ON-OFF-ON toggle switch (4 pcs.)
C	Rotary potentiometer with On/Off switch

For more information see data sheet 100-P-000163

4.2.1 General Data

Electrical Characteristics	Unit	Description, value,
Supply voltage	V	12 ... 30 smoothed DC. Ripple < 10%
Total current consumption	A	≤ 25
Number of electrical power outputs		$\eta_{prop} = 2$ $\eta_{switch} = 14$
Number of hydraulic operating positions		$\eta_{prop} = 2$ $\eta_{switch} = 18$ (with LVS valve block)
Adjustable minimum current	A	$I_{min} = 0,2 \dots 1,2$
Adjustable maximum current	A	$I_{max} = I_{min} + 0,4 \dots 2,5$
Maximum permissible output current	A	$I_{max} = 2,5$
Dither frequency	Hz	100
Protection class		IP65
Operating temperature	°C	-25 ... +70
Dimensions W / L / H	mm	264 / 200 / 170
Weight	kg	2,84
Connection type HAN 25D		25-pin

4.2.2 Symbols on the operating interface (available symbols, see 3.2.3)



IMPORTANT!:

For quantities <10 pieces per lot size, the symbols will be supplied in the form of weather- and UV-resistant adhesive labels. Customised membranes, front panels with sub-surface printing on anodised aluminium, and variations of the configuration can be supplied from 10 pieces at extra cost.

4.2.3 Ordering code

Description	Ordering code	Part number
Control unit for towed machines	EBT-620108-AS-AGRI-100035218	100035218

5 Accessories

IMPORTANT!:

EPOM offers system solutions that are ideally matched to customer requirements. The valve blocks are expertly configured and assembled by Bucher Hydraulics. The below-listed accessories for block-mounting the sections are part of the system solution and include the costs for assembling the block in conformance with the Machinery Directive, and for priming the valve block to the strictest environmental-protection regulations.

5.1 Block accessories, LVS

5.1.1 Calculating the tie bolt length

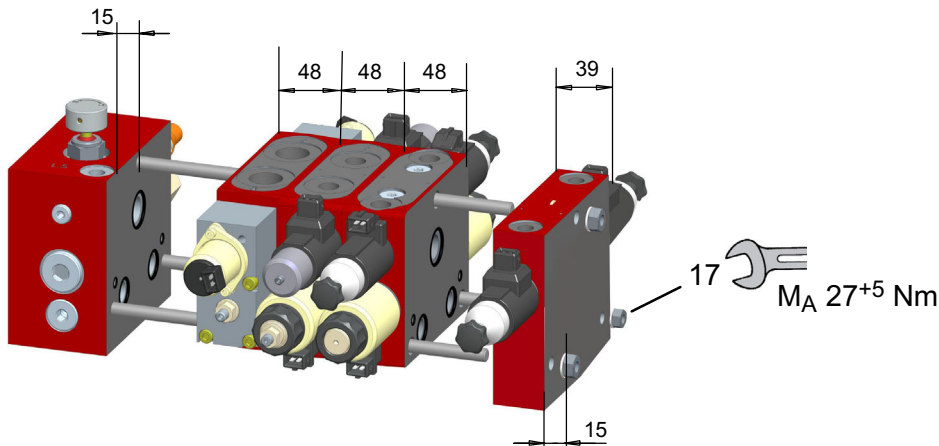

15 mm + width of all directional and function sections + width of the end section + 15 mm

Example: $15 + (48 \times 3) + 39 + 15 = 213$ mm

For ordering purposes, always round up the calculated tie

bolt length to the next 10 mm.

In our example, we therefore need to order the ZUB LVS 3-Fach 220 mm.

IMPORTANT!:

A maximum of 10 directional valve sections can be assembled in one valve block

5.1.2 Ordering information

Designation	Description	List of parts	Part number
ZUB LVS 2-Fach 170 mm	Accessories for block-mounting two sections	3 pcs. tie bolt M10x170 3 pcs. hex nut M10 3 pcs. washer D10	1001331571
ZUB LVS 3-Fach 220 mm	Accessories for block-mounting three sections	3 pcs. tie bolt M10x220 3 pcs. hex nut M10 3 pcs. washer D10	1001332021
ZUB LVS 4-Fach 260 mm	Accessories for block-mounting four sections	3 pcs. tie bolt M10x260 3 pcs. hex nut M10 3 pcs. washer D10	1001332001
ZUB LVS 5-Fach 310 mm	Accessories for block-mounting five sections	3 pcs. tie bolt M10x310 3 pcs. hex nut M10 3 pcs. washer D10	1001331581
ZUB LVS 6-Fach 360 mm	Accessories for block-mounting six sections	3 pcs. tie bolt M10x360 3 pcs. hex nut M10 3 pcs. washer D10	1001331591
ZUB LVS 7-Fach 410 mm	Accessories for block-mounting seven sections	3 pcs. tie bolt M10x410 3 pcs. hex nut M10 3 pcs. washer D10	1001331601
ZUB LVS 8-Fach 450 mm	Accessories for block-mounting eight sections	3 pcs. tie bolt M10x450 3 pcs. hex nut M10 3 pcs. washer D10	1001331611

Designation	Description	List of parts	Part number
ZUB LVS 9-Fach 500 mm	Accessories for block-mounting nine sections	3 pcs. tie bolt M10x500 3 pcs. hex nut M10 3 pcs. washer D10	1001331621
ZUB LVS 10-Fach 550 mm	Accessories for block-mounting ten sections	3 pcs. tie bolt M10x550 3 pcs. hex nut M10 3 pcs. washer D10	1001331631

5.2 Block accessories, SVH04

5.2.1 Calculating the tie bolt length

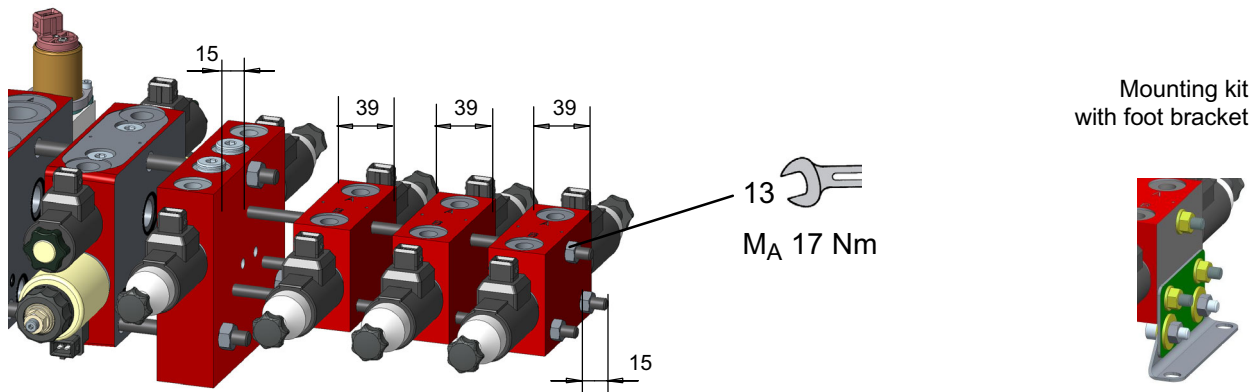

15 mm + width of all seat valve sections + width of the end section +15 mm

Example: $15 + (39 \times 2) + 39 + 15 = 147$ mm

For ordering purposes, always round up the calculated tie

bolt length to the next 10 mm.

In our example, we therefore need to order the ZUB SVH04 3-Fach, 150 mm.

IMPORTANT!:

A maximum of 11 SVH seat valve sections can be combined in one valve block.

If more than 4 seat-valve sections are used, a foot bracket must be fitted for support.

5.2.2 Ordering code

Designation	Description	List of parts	Part number
ZUB SVH04 0-Fach	Accessories for plugging the adapter section	2 pcs. plug screw M8x1	100133164
ZUB SVH04 1-Fach	Accessories for attaching one section	3 pcs. cylinder head screw M8x50 3 pcs. washer D8	1001332011
ZUB SVH04 2-Fach	Accessories for block-mounting two sections	3 pcs. cylinder head screw M8x90 3 pcs. washer D8	1001331651
ZUB SVH04 3-Fach	Accessories for block-mounting three sections	3 pcs. tie bolt M8x150 3 pcs. hex nut M8 3 pcs. washer D8	1001331661
ZUB SVH04 4-Fach	Accessories for block-mounting four sections	3 pcs. tie bolt M8x190 3 pcs. hex nut M8 3 pcs. washer D8	1001331671
ZUB SVH04 5-Fach	Accessories for block-mounting five sections	3 pcs. tie bolt M8x230 3 pcs. hex nut M8 3 pcs. washer D8 1 pc. mounting kit	1001331681
ZUB SVH04 6-Fach	Accessories for block-mounting six sections	3 pcs. tie bolt M8x270 3 pcs. hex nut M8 3 pcs. washer D8 1 pc. mounting kit	1001331691

Designation	Description	List of parts	Part number
ZUB SVH04 7-Fach	Accessories for block-mounting seven sections	3 pcs. tie bolt M8x310 3 pcs. hex nut M8 3 pcs. washer D8 1 pc. mounting kit	1001331701
ZUB SVH04 8-Fach	Accessories for block-mounting eight sections	3 pcs. tie bolt M8x350 3 pcs. hex nut M8 3 pcs. washer D8 1 pc. mounting kit	1001331711
ZUB SVH04 9-Fach	Accessories for block-mounting nine sections	3 pcs. tie bolt M8x390 3 pcs. hex nut M8 3 pcs. washer D8 1 pc. mounting kit	1001331721
ZUB SVH04 10-Fach	Accessories for block-mounting ten sections	3 pcs. tie bolt M8x430 3 pcs. hex nut M8 3 pcs. washer D8 1 pc. mounting kit	1001331731
ZUB SVH04 11-Fach	Accessories for block-mounting eleven sections	3 pcs. tie bolt M8x470 3 pcs. hex nut M8 3 pcs. washer D8 1 pc. mounting kit	1001331741

5.3 General accessories

Designation	Description	List of parts	Part number
EBT-6-Ball mount	For a flexible mounting of the control unit EBT610 and EBT620	1 pc. ball mount 1 pc. mounting plate 4 pcs. cap screw M4x12	1001333511
EBT-6-Rubber-metal bumper	For a firm mounting of the control unit EBT610 and EBT620, e.g. on a mounting panel	4 pcs. rubber bumper 4 pcs. hex screw M4x6 4 pcs. lock washer	1001333521
EBT-6-Wiring harness	For wiring the control unit EBT610 and 620 with the valve block	See Section 4.2	100035336
Dummy plug	For capping unused solenoid connectors on the wiring harness	1 pc. dummy plug	100236644
EBT-6-Mounting plate	For mounting the wiring harness at the valve block	1 pc. mounting plate 4 pcs. hex screw M4x8	1001333531

5.3.1 EBT-6-Ball mount 1001333511



5.3.2 EBT-6-Rubber bumper 1001333521



5.4 EBT-6-Wiring harness, 100035336

Custom configurations can be supplied from 10 pieces at extra cost.

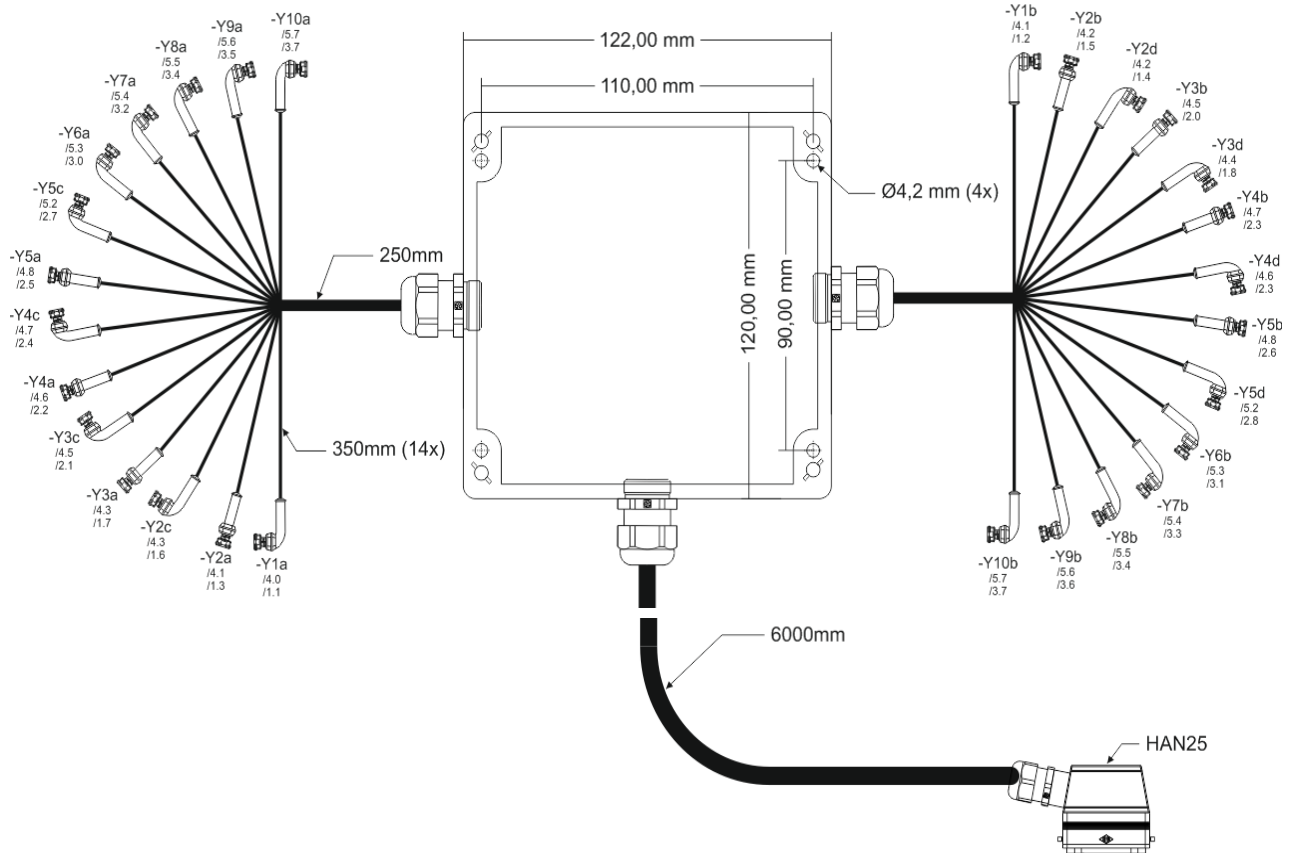

EPOM system solution for towed machines

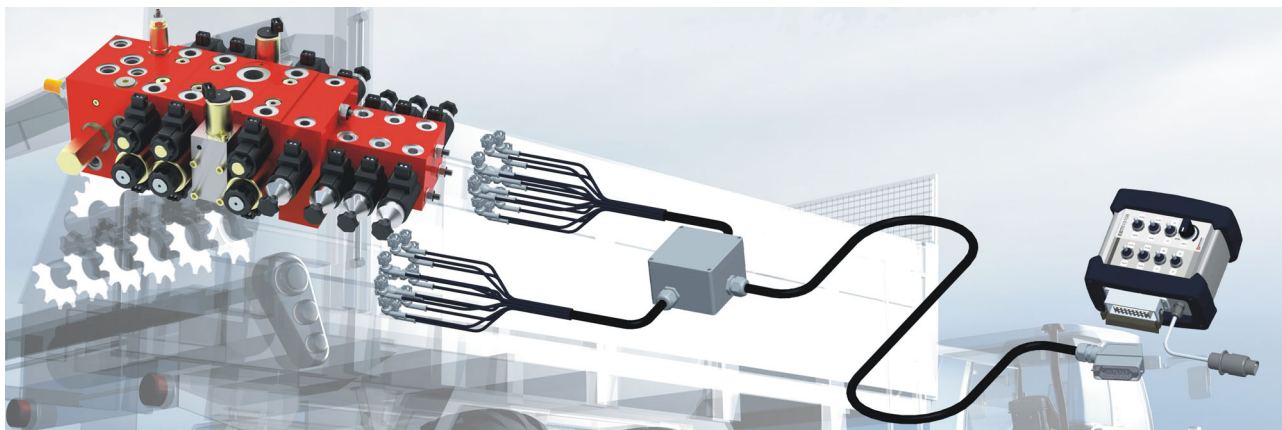

info.kl@bucherhydraulics.com

www.bucherhydraulics.com

© 2019 by Bucher Hydraulics GmbH, D-79771 Klettgau

All rights reserved.

Data is provided for the purpose of product description only, and must not be construed as warranted characteristics in the legal sense. The information does not relieve users from the duty of conducting their own evaluations and tests. Because the products are subject to continual improvement, we reserve the right to amend the product specifications contained in this catalogue.

Classification: 430.300.330.