

# Faster

easier to connect.

## Product Overview



OIL SOLUTIONS

PO Box 38  
Strathfieldsaye, VIC, 3551

1800 OIL SOL

1800 645 765

[sales@oilsolutions.com.au](mailto:sales@oilsolutions.com.au)

[www.oilsolutions.com.au](http://www.oilsolutions.com.au)

"For All Your Hydraulic Needs"





---

With 70 years of experience in the hydraulic industry, Faster has designed and manufactured over 500 million quick-release couplings and has registered more than 100 patents.

Our product portfolio entails several solutions, grouped into 3 main areas: single couplings, Casting Solutions, and MultiFaster.

Our offer covers several areas of application, including Agriculture, Mobile & Construction Equipment, Industrial & Other Applications.

---

#### ICONS LEGEND



Connection Under Pressure:  
Allowed Male Half up to W.P.



Connection Under Pressure:  
Allowed Both Halves



Connection Under Pressure:  
Allowed Residual



Connection and disconnection  
under residual pressure both halves



Disconnection Under Pressure:  
Allowed Male Half up to W.P.



Connection Under Pressure:  
Not Allowed



---

# Agriculture

---

Agriculture is the leading field of application for quick-release hydraulic couplings. Faster has developed a full range of products, covering all the hydraulic connections on regular tractors, both on rear hydraulic lines and front loaders. Moreover, we have selected products specifically designed for harvesting applications.

- Sleeve Retraction
- Push-Pull
- High Flow
- Power Beyond
- Castings
- Multifaster For Front Loaders
- Multifaster For Harvesting

# Sleeve Retraction



## NV



Male and Female couplings with poppet valve shut-off system.  
Available in size; 1/4", 3/8", 1/2", 3/4", 1", 1-1/4", 1-1/2", 2".

### Accessories and spares



TM.../TF...



TM...S/TF...S



TM12-38



Seal kits

## ANV



Standard couplings for agriculture applications.  
Available in size; 1/4", 3/8", 1/2", 3/4", 1", 1-1/4", 1-1/2", 2".

### Accessories and spares



Seal kits

## ANV Zinc-Nickel



Standard couplings for agriculture applications with Zn-Ni surface treatment for improved resistance.  
ISO 7241 part A interchange.  
Available in size; 1/4", 3/8", 3/4", 1".

### Accessories and spares



Seal kits

# Push-Pull



## CPV Zinc-Nickel



Push-pull couplings, designed for panel mounting installation. Zinc-Nickel Surface Treatment for improved resistance. Breakaway function. ISO 7241 part A interchange. Wide range of threads available upon request.

Available in size 1/2".

### Accessories and spares



TM 12 .../TM 12-38 ...



TM 12 S



Seal kits

## 3CPV



Female couplings designed for panel mounting installation and connection to flexible hoses. Connectable with Male under residual pressure. Breakaway function. Available in size 1/2".

### Accessories and spares



TA ...



TM 12 .../TM 12-38 ...



TARV 45



Seal kits

## 6DNPV



Push-Pull Female couplings for rigid mounting connectable with Male and Female under pressure, disconnectable under pressure with low effort. Equipped with one or two oil collecting ports to collect clean oil and reduce spillage. Available in size 1/2".

### Accessories and spares



Seal kits

---

# High Flow Resistant



## 3CFHF



Male and Female Push-Pull couplings for agriculture connectable with Male under residual pressure.  
Maximum flow rate: 250 l/min.  
Breakaway function.



---

### Accessories and spares

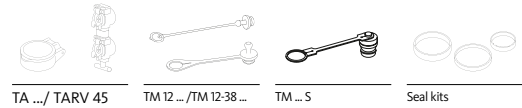

TA .../TARV 45

TM 12 .../TM 12-38 ...

TM ... S

Seal kits

## 4SRHF



Male and Female Push-Pull couplings for agriculture connectable under residual pressure in both Male and Female side.  
Maximum flow rate: 250 l/min.  
Breakaway function.



---

### Accessories and spares

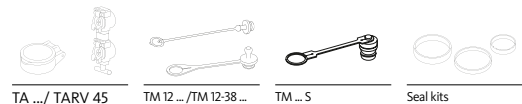

TA .../TARV 45

TM 12 .../TM 12-38 ...

TM ... S

Seal kits

---

# Power Beyond



---

## 5FPI



Flat Face couplings specifically designed for Power Beyond applications. Interchangeable according to ISO 16028. Connection and disconnection under residual pressure allowed.

Equipped with collecting port for clean oil.

Available in sizes 1/2" and 3/4".

Flow rate up to 150 l/min, depending on the size.

---

### Accessories and spares

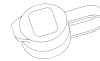

TM 5FPI ...

---

## FPI



Flat Face couplings specifically designed for Power Beyond applications. Interchangeable according to ISO 16028. Breakaway function.

Connection under pressure allowed.

Available in sizes 1/4", 3/8", 1/2", 3/4", 1".

Flow rate up to 210 l/min, depending on the size.

---

### Accessories and spares



TM FPI ...

---

# Casting Solutions



---

## Manifold with screwed couplings for Rear SCV



Cast iron manifold with 1/2" couplings screwed on. Designed to be screwed directly on control blocks. Every single casting is specifically developed for each tractor manufacturer, to meet impending space requirements. Each Faster manifold block is specifically designed to match a specific control block interface. Each manifold can be equipped with different Female couplings for agriculture, depending on the required features. It can also be upgraded with compatible couplings of different series.

---

## Block with semi-integrated cartridges for Rear SCV



Cast iron blocks equipped with two semi-integrated cartridges, available both poppet valve ISO 7241 part A and flat face ISO 16028. Available size: 1/2" and 3/4".

The same block is suitable for both ISO A and Flat Face cartridges, easy interchangeable to ensure flexibility. Push-pull connection. Great ease to connect and disconnect agricultural implements thanks to relief of internal residual pressure ensured by one dedicate lever for each line. Breakaway feature. Replacement of the lever does not require disassembling of the block.

---

## Block with integrated cartridges for Rear SCV



Cast iron block with fully integrated cartridges, connection assisted by lever.

Possible to fit either poppet or flat face cartridges in 3 different sizes: 1/2", 5/8" or 3/4".

Connection and disconnection under pressure allowed.

---

# MultiFaster for Front Loaders



## PC206



MultiFaster compact. It allows connection with mobile plate or stand-alone counterpart couplings, 2 lines 3/8".

The disconnection of stand-alone counterpart couplings is made by dedicated push buttons. This feature can be extended to all MultiFaster range.

---

### Accessories and spares



KIT3FN



Seal kits

## P508



Multifaster 4 lines, size O8.

*A brand new feature added to our MultiFaster: the automatic dust cover. A new addition applied to ease and facilitate the connection, giving the user the possibility to automatically open the dust cover, adding more comfort to the manouvre. This system is patented and soon a kit with this solution will be available.*

---

### Accessories and spares



KIT2FN



KIT3FN



Seal kits

## PSA06



MultiFaster 4 lines 3/8".

Working pressure 25 Mpa.

Flow rate @ 0.2 MPa: 40 l/min.

---

### Accessories and spares



KIT2FN

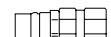

KIT3FN



Seal kits

---

# MultiFaster for Harvesting



## PLK



MultiFaster 5 lines. 2 lines size O6, 3 lines size O9, 1 housing for electrical connector.  
Working pressure 25 Mpa.  
Flow rate @ 0.2 MPa: 2 lines 20 l/min, 3 lines 35 l/min.

---

### Accessories and spares



KIT2FN



KIT3FN



Seal kits

## P5065



MultiFaster 5 lines. 3 lines O4, 2 lines O6.  
Working pressure 25 Mpa.  
Flow rate @ 0.2 MPa: 3 lines 20 l/min, 2 lines 40 l/min.

---

### Accessories and spares



KIT2FN



KIT3FN



Seal kits

## Automatic Connection



MultiFaster suitable for Harvesting, with automatic alignment system. Fixed plate designed to self-align with mobile plate to complete connection. This kind of product allows the operator to complete the connection with safety, comfort and time saving. This MultiFaster can be customized with addition of electrical connectors.





---

# Mobile & Construction Equipment

---

Construction Equipment is a challenging field of application for quick-release hydraulic couplings, where couplings must perform in tough environmental conditions, due to dust, mud, vibrations, temperature and pressure peaks. Faster has developed several solutions for the CE market, including Flat Face couplings, to avoid any leakage, Screw to Connect couplings, robust and reliable, and Casting solutions, to ensure the connection of multiple lines with decompression feature.

- Flat Face
- Screw To Connect
- Castings Solutions
- Multifaster

# Flat Face



## FFH



Flat Face Male and Female couplings.  
The flat valve shut-off system prevents contamination and spillage.  
Real maximum working pressure of 35 MPa and Zinc-Nickel plating. Available sizes: 1/8", 1/4", 3/8", 1/2", 5/8", 3/4", 1".  
Interchangeable according to ISO 16028.  
Size 1/8" has surface treatment in Mate 500 (CrIII) and it is not ISO interchangeable.

### Accessories and spares



TAF ...



TMF 38 .../TFF 38 ...



TM 2FI .../TF 2FI ...



TM2FI...S/TMFFH...S  
TF2FLS/TFFFH...S

## 3FFH



Flat Face Male and Female couplings.  
The flat valve shut-off system prevents contamination and spillage.  
Real maximum working pressure of 35 MPa and Zinc-Nickel plating.  
Connectable under residual pressure. It is possible to couple either a 3FFH Female half under pressure with a FFH Male half, or a 3FFH Male half under pressure with a FFH Female half.  
Available sizes: 3/8", 1/2", 5/8", 3/4".  
Interchangeable according to ISO 16028.

### Accessories and spares



TAF ...



TMF 38 .../TFF 38 ...



TM 2FI .../TF 2FI ...



TM2FI...S/TMFFH...S  
TF2FLS/TFFFH...S

## FSH



Flat Face Female couplings, equipped with sector latching technology.  
The sector latching system enables to effectively tackle the Brinelling effect, provoked by high frequency impulse pressures.  
Real maximum working pressure of 35 MPa and Zinc-Nickel plating.  
Connectable under residual pressure in the Male half when coupled with a 3FFH Male coupling.  
Available sizes: 3/8", 1/2", 3/4", 1".  
Interchangeable according to ISO 16028.

### Accessories and spares



TAF ...



TMF 38 .../TFF 38 ...



TM 2FI ...



TM 2FI ... S

# Screw to Connect



## FHV



Screw-on Flat Face couplings, suitable for construction equipment and heavy duty applications. The Zinc-Nickel plating guarantees a remarkable resistance to corrosion. No hose torsion during connection and disconnection thanks to the internal bearing system. Equipped with a safety sleeve to prevent accidental disconnections due to vibrations. Faster proprietary profile. Part Number with ET have Extended Temperature Range (from -30° to 120 ° C) in connected configuration. Female Part Number with IP are certified Ingress Protection 54. Male Part Number with K are the compact version. Available sizes: 3/8", 1/2", 3/4", 1", 1-1/4", 1-1/2", 2".

### Accessories and spares



TM-TF FHV ...



TM FHV ...S/TF FHV ...S



Seal kits

## FLV



Screw-on Flat Face couplings, with extremely compact and robust design.

Ideal for applications in which a flat face connection is required and there are no significant residual pressures to manage.

Available sizes: 3/8", 1/2", 3/4", 1".

## OGV ST



Screw to connect couplings for Oil & Gas application, market interchange.

Equipped with a marker that confirms the complete connection and a longer locking sleeve for an improved engagement.

Available sizes: 1-1/2", 2".

### Accessories and spares

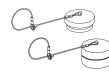

TM OGV ... S/  
TF OGV ... S

---

# Casting Solutions



---

## Auxiliary Lines Block (3 ports)



Castings with cartridges for Construction Equipment. The first cast iron block ever designed to quickly connect and disconnect attachments on skid steers and other light equipment machines. Designed to connect the circuit with residual pressure on both ends. The decompression feature allows to connect the circuit with residual pressure on both ends. 1/2" and 3/4" cartridges can both fit into the 4BD4FH block. Higher flow capability is guaranteed when using 3/4" cartridges. Can be equipped with 4FFH or 4FSH cartridges. Cartridges share all the benefits of the FFH/FSH couplings technology.

---

## Auxiliary Lines Block (3+2 HF ports)



5 Lines block unifies two hydraulic lines of different dimensions in one single casting, giving the option to decompress both lines and collect the drained oil in one single line. The block connects to the machine hydraulic circuit thanks to only two adaptors, and divides the oil flow between the above line and the below line by internal channels properly designed to optimize the flow. This solution offers a great flexibility to the machine in the use of a larger range of attachments and a very easy installation.

The cast iron block shown in the picture is for illustrative purposes only.  
The shape of each block is tailor designed to meet the manufacturer's dimensional requirements.

# MultiFaster



## P4A



MultiFaster 4 lines. 2 lines size 1", 2 lines size 1/2", available with electrical connector in 1/2".  
Workig pressure: 25 MPa.  
Flow rate @ 0.2 MPa: 2 lines 70 l/min, 2 lines 150 l/min.

### Accessories and spares

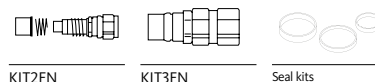

KIT2FN

KIT3FN

Seal kits

## MultiGrease



MultiFaster with special cartridge for central lubrication system and an electrical connector (7 pins) included. 2 lines, size 1/2".  
This feature (special cartridge equipped with shunt system) can be extended to all MultiFaster range.

### Accessories and spares

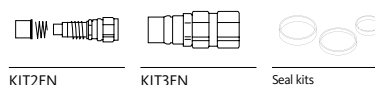

KIT2FN

KIT3FN

Seal kits

## PH510 S



MultiFaster 4 lines for High Pressure applications. 2 lines size O8, 2 lines size 12. Working Pressure: 46 MPa.  
Flow rate @ 0.2 MPa: 2 lines 60 l/min, 2 lines 105 l/min.

### Accessories and spares

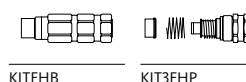

KITFHB

KIT3FHP



---

# Industrial & Other Applications

---

The Industrial applications field is a wide area and it includes several concepts. Products designed for industrial production are used in order to reduce downtime during maintenance operations. This products are generally characterized by different materials and different levels of performances, to match a broad variety of applications.

- Sleeve Retraction / ISO 7241 - B
- Flat Face / ISO 16028
- Screw to Connect /Faster Interchange
- High Pressure
- Oil & Gas / Snap Tite
- BOP
- Refrigeration
- Check Valves & Diagnostic
- Special Solutions
- Automatic Multiconnections
- MultiFaster for Industrial Applications
- MultiFaster for High Pressure

# Sleeve Retraction / ISO 7241 - B



## HNV



Male and Female couplings for industrial applications with poppet valve shut-off system. Complete range of sizes available with BSP, NPT and SAE Female threads. Interchangeable according to ISO 7241 Part B.

Available sizes: 1/8", 1/4", 3/8", 1/2", 3/4", 1", 1-1/2", 2".

### Accessories and spares



TMH ... / TFH



TMH ... S / TFH ... S



Seal kits

## HNV brass



Male and Female couplings for industrial applications with poppet valve shut-off system. Brass version available with NBR or Viton seals. Interchangeable according to ISO 7241 Part B.

Available sizes: 1/8", 1/4", 3/8", 1/2", 3/4", 1", 1-1/2".

### Accessories and spares



TMH ... / TFH



TMH ... S / TFH ... S



Seal kits

## HNV stainless steel



Male and Female couplings for industrial applications with poppet valve shut-off system. Stainless Steel version (AISI 316) with Viton seals. Interchangeable according to ISO 7241 Part B.

Available sizes: 1/4", 3/8", 1/2", 3/4", 1", 1-1/2", 2".

### Accessories and spares



TMH ... / TFH



TMH ... S / TFH ... S



Seal kits

# Flat Face / ISO 16028



## FFH



Flat Face Male and Female couplings for industrial applications. Steel version (Mate 1000) with seals in NBR. Interchangeable according to ISO 16028. Available sizes: 1/8", 1/4", 3/8", 1/2", 3/4", 1", 1-1/2".

### Accessories and spares



TAF ...



TMF 38 .../TFF 38 ...



TM 2FI .../TF 2FI ...



TM 2FI ...S/TMFFH ...S  
TF 2FL ...S/TFFFH ...S

## 2FFI brass



Flat Face Male and Female couplings for industrial applications. Brass version with seals in Viton. Interchangeable according to ISO 16028. Available in size 1/2".

### Accessories and spares



TM 2FI .../TF 2FI ...



TM 2FI ...S/TF 2FL ...S

## 2FFI stainless steel



Flat Face Male and Female couplings for industrial applications. Stainless Steel version (AISI 316) with Viton seals. Available sizes: 1/4", 3/8", 1/2", 3/4", 1".

### Accessories and spares



TFF 38 ...



TM 2FI .../TF 2FI ...



TM 2FI ...S/TF 2FL ...S

# Screw to Connect /Faster Interchange



## FHV HD



Screw-on flat face couplings, equipped with a double Bearing Ball system and greasing nipple. The Zinc-Nickel plating guarantees a remarkable resistance to corrosion. Connectable by hand up to 35 MPa residual pressure in the male half. No hose torsion during connection and disconnection thanks to the internal bearing system. Equipped with a safety sleeve to prevent accidental disconnections due to vibrations. Available sizes: 1", 1-1/4", 1-1/2".

### Accessories and spares



TM-TF FHV ...

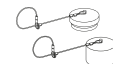

TM FHV ...S/  
TF FHV ...S



Seal kits

## VV



Screw to connect standard couplings, double function sleeve. VV series couplings are very robust and reliable and allow to connect under residual pressure. Thanks to a double function sleeve it's also possible to connect a female part with either VV or NV male halves. Faster proprietary profile. Available sizes: 1/4", 3/8", 1/2", 3/4", 1".

### Accessories and spares



TMV 38 / TFV 38



TMVM ... / TFVM ...



TMV ... SS/  
TFV ... SS



Seal kits

## VVS



Screw to connect couplings for high pressure applications. Couplings commonly used for applications characterized by very high working pressures and peaks. Heavy duty internal components guarantee the maximum safety and reliability. Faster proprietary profile. Interchangeable with Faster VV series. Available sizes: 1/4", 3/8", 1/2", 3/4", 1-1/4", 1-1/2", 2" .

### Accessories and spares



TMVM ... / TFVM ...



TMV ... SS/  
TFV ... SS



Seal kits

# High Pressure



## PVVM



Screw to Connect Male and Female couplings, suitable for High Pressure applications. Equipped with a robust metal-to-metal sealing poppet valve. Maximum Working Pressure: 100 MPa. Connection under pressure: allowed residual in one of the two halves. Interchangeable according to ISO 14540. Available sizes: 1/4", 3/8".

### Accessories and spares



TMP .../TFP ...



Seal kits

## PVSM



Screw to Connect Male and Female couplings, suitable for High Pressure applications. Equipped with a metal-to-metal sealing ball valve. Maximum Working Pressure: 72 MPa. Connection under pressure: allowed residual in one of the two halves. Interchangeable according to ISO 14540. Available in size 3/8".

### Accessories and spares



TMP .../TFP ...



Seal kits

## FFHP



Flat Face Male and Female couplings, suitable for High Pressure applications. Flat valve shut-off system prevents contamination and spillage. Zinc-Nickel plating ensures good resistance to wear and corrosion. Maximum Working Pressure: 72 MPa. Available sizes: 1/4", 3/8".

# Oil & Gas / Snap Tite



## OGV



Standard screw-to-connect coupling suitable for Oil & Gas applications. Robust sleeve design, poppet valve and ACME connection thread.

Connection under pressure: allowed residual in one of the two halves.

Available sizes: 1-1/2", 2"

### Accessories and spares

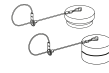

TM OGV ... S/  
TF OGV ... S

## OGF



Male and Female couplings, suitable for Oil & Gas applications. Poppet valve designed to help flow and allow connection with TNL parts (free flow) same series. Interchangeable with Faster TNL couplings.

Available sizes: 1/4", 3/8", 1/2", 3/4", 1", 1-1/4", 1-1/2"

### Accessories and spares

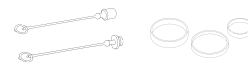

TMH .../TFH ...

Seal kits

## TNV



Flat Face Male and Female couplings suitable for Oil & Gas applications.

The Flat Face design guarantees very low spillage and prevents external contamination.

Equipped with locking ball to prevent accidental disconnection.

Interchangeable with Snap-tite 71 series.

Available in sizes: 1/4", 3/8", 1/2", 3/4", 1"

# BOP



## HNV FR



Male and Female couplings with poppet valve shut-off system, Lloyd's certified, suitable for Oil & Gas applications. Thanks to special components and seals, HNVFR couplings are API 16 D certified and suitable for BOP application. Interchangeable according to ISO 7241 Part B.  
Available sizes: 1/2", 3/4", 1"

### Accessories and spares



TMH ... / TFH

## FHV FR



Screw-to-Connect Flat Face couplings, Lloyd's certified, suitable for Oil & Gas applications. Equipped with a safety sleeve to help preventing accidental disconnections due to vibrations. Zinc-Nickel plating. Thanks to special components and seals, FHVFR couplings are API 16 D certified and suitable for BOP application. Connectable with residual pressure in the Male half up to 35 MPa. Faster proprietary profile.  
Available sizes: 3/4", 1"

### Accessories and spares



TM-TF FHV ...

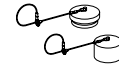

TM FHV ... S/  
TF FHV ... S

## OGV FR



Screw to Connect Male and Female couplings, Lloyd's certified, suitable for Oil & Gas applications. Robust sleeve design, poppet valve and ACME connection thread. Thanks to special components and seals, OGVFR couplings are API 16 D certified and suitable for BOP application. Connection under pressure: allowed residual in one of the two halves.  
Available sizes: 3/4", 1", 1-1/4"

### Accessories and spares

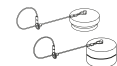

TM OGV ... S/  
TF OGV ... S

# Refrigeration



**RF**



Screw to connect couplings for air conditioning & refrigeration application. Interchangeability according to market driven standards. Available in several versions in steel, brass and with copper sweat braise adaptor

Available in sizes: 1/4", 3/8", 1/2", 3/4", 1".

## Accessories and spares



TMRF .../TFRF ...

**RFL**



Screw to connect female couplings for air conditioning & refrigeration application, low friction sleeve.

The female couplings are equipped with a low friction sleeve in order to reduce connection effort and friction. Fully interchangeable with RF series same size.

Available in sizes: 1/4", 3/8", 1/2", 3/4", 1".

## Accessories and spares



TMRF .../TFRF ...

**RFLS - RFS**



RFLS screw-to-connect female couplings are equipped with a low friction sleeve to reduce connection effort together with an integrated safety sleeve to prevent accidental disconnections. Corresponding male couplings RFS series are characterized by Faster profile interchangeability. Available in sizes: 1/4", 3/8", 1/2", 3/4".

## Accessories and spares



TMRFLS .../  
TFRFLS ...

---

# Check Valves & Diagnostic

---

## VU



Standard unidirectional check valves, acting as a safety device into hydraulic systems. Standard versions contain a spring set to open the valve at 35 kPa; Normally available with inlet and outlet Female threads. Wide range of calibrations available, from 10 to 950 kPa.

Available sizes: 1/4", 3/8", 1/2", 3/4", 1", 1-1/4", 1-1/2", 2".

---

## VUC



Compact check valves, acting as a safety device into hydraulic systems. Very compact design, assembled with only one piece body. Standard cracking pressure 35 kPa.

Available sizes: 1/4", 3/8", 1/2", 3/4", 1".

---

## DF



Diagnostic Flat Face Male and Female couplings, specifically designed to measure the internal pressure of hydraulic circuits. Male part to be mounted on the hydraulic line, Female part to be connected to gauge instruments.

Interchangeable according to ISO 15171-1.

Available in size 1/4".

---

### Accessories and spares



TDFD 04

---

# Special Solutions

---

## FFC



Flat Face Male and Female cartridge couplings in Stainless Steel (AISI 316) with Viton seals. Self-aligning couplings for MultiFaster. Misalignments up to  $\pm 0.5$  mm and  $\pm 1^\circ$  (angular) are automatically compensated during the connection. Faster proprietary profile.  
Available sizes: 1/4", 3/8", 1/2".

---

## FFHB

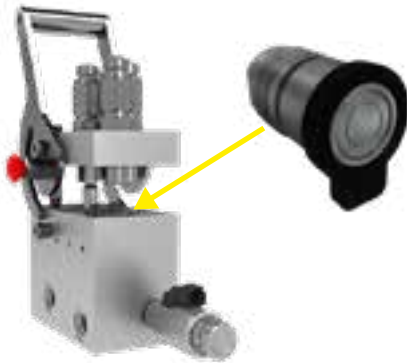

Integrated flat face cartridge, suitable for hydraulic multiconnections and manifolds. Thanks to its special sleeve button it is possible to connect the cartridge with dedicated plate counterpart or with single couplers. The cartridge allows frontal assembly with a dedicated tool. Conforms to ISO 16028 interchange standard.  
Available sizes: 3/8", 1/2", 3/4".

---

### Accessories and spares



FFHB ... TOOL

---

# Automatic Multiconnection

---

## Steel Industry



Multiconnection suitable for steel industry application (Rolling), with automatic alignment system. Rolling is a metal forming process in which metal stock is passed through one or more pairs of rolls to reduce thickness, or to make thickness uniform. The group of rolls is enclosed in a cage. This Multiconnection can be customized with the addition of electrical connectors.

---

## Thermoforming Industry



Multiconnection suitable for thermoforming industry application, with automatic alignment system. Thermoforming is a manufacturing process where a plastic sheet is heated to a pliable forming temperature, formed to a specific shape in a mold, and finally trimmed to create a usable product. This technology is typically employed, other than in the automotive, sanitary and industrial sectors, in the manufacturing of refrigerators. This Multiconnection can be customized with the addition of electrical connectors.

---

## Automotive Engine Test



Multiconnection suitable for End-of-line engine testing. The automatic connection of multiple lines (hydraulic, pneumatic, electrical) allows quick and reliable fill of external media needed to run the test, contributing to a massive reduction of the setup time for the whole process.

---

# MultiFaster for Industrial Applications

---

## M001



MultiFaster 2 lines size 06. Working Pressure 25 MPa. This special MultiFaster is designed for CNC machines applications. CNC machines are highly automated manufacturing tools controlled by a computer. Thanks to this MultiFaster it's possible to pressurize all the hydraulic cylinders which block the pieces with one single maneuver, reducing the overall cycle time.

---

### Accessories and spares

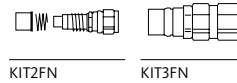

KIT2FN

KIT3FN

---

## P10A



MultiFaster 10 lines. 5 lines size 08, 5 lines size 04. Working Pressure 25 MPa. Flow rate @ 0.2 MPa: 5 lines 70 l/min, 5 lines 20 l/min.

---

### Accessories and spares

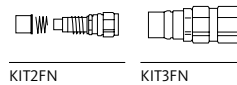

KIT2FN

KIT3FN

---

## P12A



MultiFaster 12lines. 10 lines size 08, 2 lines size 04. Working Pressure 25 MPa. Flow rate @ 0.2 MPa: 10 lines 70 l/min, 2 lines 20 l/min.

---

### Accessories and spares

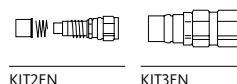

KIT2FN

KIT3FN

---

# MultiFaster for High Pressure



## PH216S



MultiFaster for High Pressure applications.  
2 lines size 16. Working Pressure: 46 MPa.  
Flow rate @ 0.2 MPa: 60 l/min.

---

### Accessories and spares

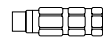

KITFHB



KIT3FHP

## PH408S



MultiFaster for High Pressure applications.  
4 lines size 08. Working Pressure: 46 MPa.  
Flow rate @ 0.2 MPa: 60 l/min.

---

### Accessories and spares

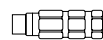

KITFHB



KIT3FHP

## PH510S



MultiFaster 4 lines for High Pressure applications. 2 lines size 08, 2 lines size 12. Working Pressure: 46 MPa.  
Flow rate @ 0.2 MPa: 2 lines 60 l/min, 2 lines 105 l/min.

---

### Accessories and spares



KITFHB



KIT3FHP





We are the global reference  
in quick-release hydraulic couplings

**Faster Srl**  
Via Ludovico Ariosto, 7  
I-26027 Rivolta d'Adda  
Cremona, Italy  
T +39 0363 377211  
F +39 0363 377333  
info@fastercouplings.com  
www.fastercouplings.com

BR\_PROD0V\_2022