



F420 SERIES

In line high pressure filters

Inline filters for operating pressure up to 420 bar, flow rate up to 400 l/min.

Available with or without bypass, indicator port is a standard option to fit a visual or electrical differential indicator.

TECHNICAL INFORMATION

HOUSING

tested according to NFPA T3.10.5.1 , ISO3968

HYDRAULIC SYMBOL:

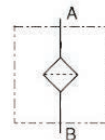
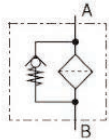

PRESSURE:

Max operating: 420 bar
Burst: 1260 bar

CONNECTION PORTS:

G 1/2" ÷ 1 1/2"

MATERIALS:

Head: cast iron
Bowl: extruded steel
Seal: NBR (FKM on request)

BYPASS:

No by-pass or 6 bar setting

ELEMENT

tested according to ISO 2941, 2942, 2943, 3968, 16889, 23181

FILTER MEDIA:

Inorganic microfiber: G03 - G06 - G10 - G15 - G25
Paper: C10

DIFFERENTIAL COLLAPSE PRESSURE:

21 bar or 210 bar

OPERATING TEMPERATURE RANGE:

-25°C +100°C

FLUID COMPATIBILITY:

Full with HH-HL-HM-HV (acc. To ISO 2943).
For use with other fluid please contact Filtrac Customer Service (info@filtrac.it).

OVERALL DIMENSIONS

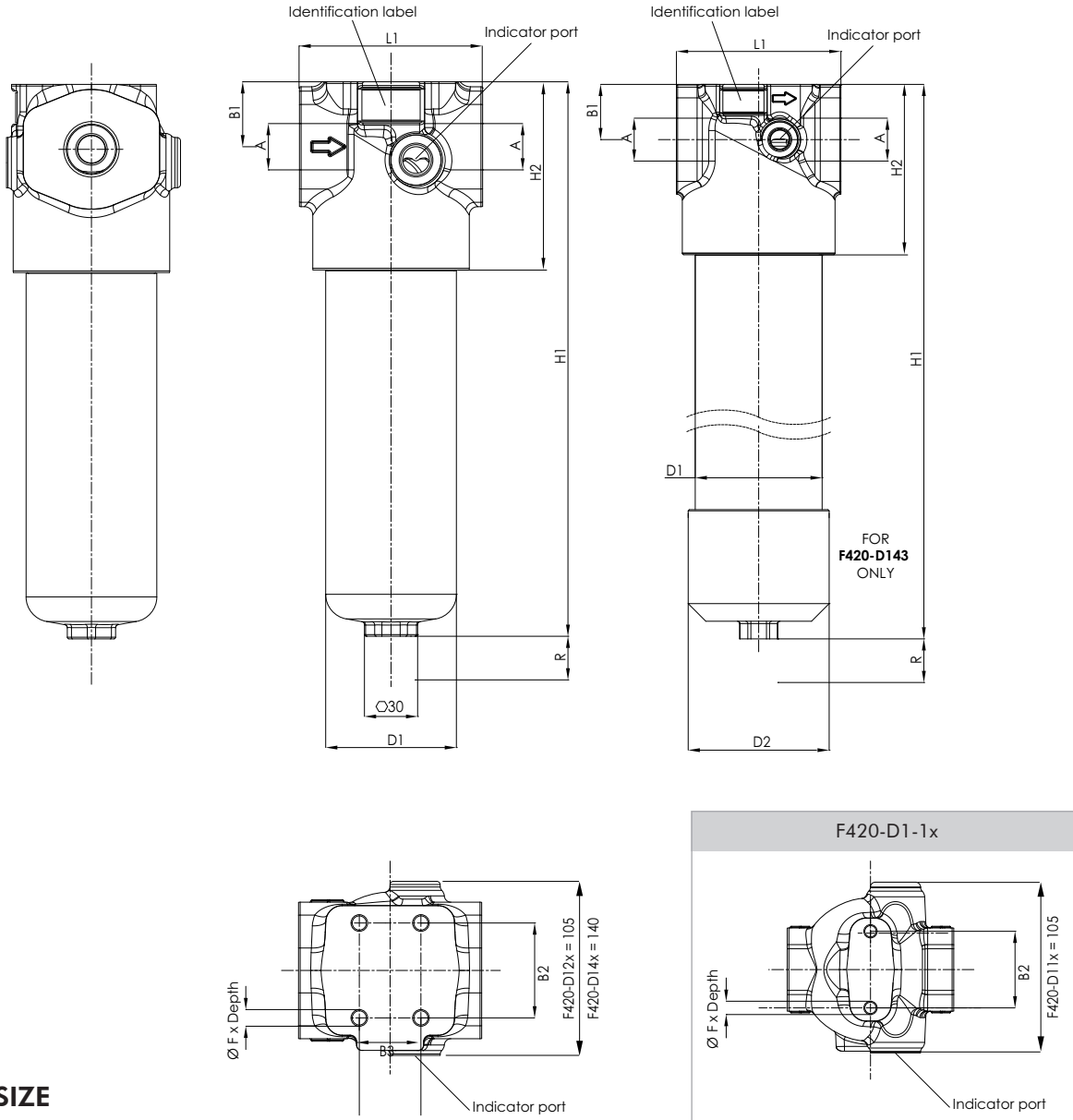

NOMINAL SIZE

MODEL	A	B1	B2	B3	D1	D2	F	H1	H2	L1	R	WEIGHT
F420-D110	G 1/2" G 3/4"	27	46	-	70	-	M8x15	183	103	100	130	4,1Kg
F420-D111		27	46	-	70	-	M8x15	210				4,4 Kg
F420-D112		27	46	-	70	-	M8x15	303				5,4 Kg
F420-D120	G 3/4" G 1"	39	57	37	78,5	-	M10x18	222	113	110	130	6,7 Kg
F420-D121		39	57	37	78,5	-	M10x18	333				8,4 Kg
F420-D124		39	57	37	78,5	-	M10x18	268				7,4 Kg
F420-D140	G 1" G 1 1/4 G 1 1/2	47	76	64	108	-	M12x22	262	145	140	140	13,2 Kg
F420-D141		47	76	64	108	-	M12x22	355				15,5 Kg
F420-D142		47	76	64	108	-	M12x22	475				18,4 Kg
F420-D143		47	76	64	108	120	M12x22	568				22,8 Kg



1800-OILSOL
1800-645765

<https://oilsolutions.com.au/>

sales@oilsolutions.com.au

ORDERING INFORMATION

	1.	2.	3.	4.	5.	6.	7.	8.	9.	10.
	F420	D1	20	G10	A	B	B4	D	W	E05
SPARE ELEMENT		D1	20	G10	A					

1. FILTER SERIES	F420		
2. FILTER ELEMENT SERIES	D1		
3. FILTER SIZE	10-11-12		
	20-21-24		
	40-41-42-43		
4. FILTER MEDIA	000	no element	
	G03	glassfiber $\beta_{4,5\mu\text{m(c)}} > 1.000$	
	G06	glassfiber $\beta_{7\mu\text{m(c)}} > 1.000$	
	G10	glassfiber $\beta_{12\mu\text{m(c)}} > 1.000$	
	G15	glassfiber $\beta_{18\mu\text{m(c)}} > 1.000$	
	G25	glassfiber $\beta_{22\mu\text{m(c)}} > 1.000$	
	C10	paper $\beta_{10\mu\text{m(c)}} > 2$	only for Dp 21 bar
5. ELEMENT COLLAPSE	A	21 bar	
	B	210 bar	recommended with no by-pass option
6. SEALS	B	NBR	
	V	FKM	
7. CONNECTIONS For different thread options please check availability with Filtrtec Customer Service.	B3	G 1/2"	for size 10 to 24
	B4	G 3/4"	
	B5	G 1"	for size 20 to 43
	B6	G 1 1/4"	
	B7	G 1 1/2"	for size 40 to 43
	H6M	1 1/4" SAE J518-6000 - flange	
	H7M	1 1/2" SAE J518-6000 - flange	
8. BYPASS VALVE	0	no by-pass	
	D	6 bar	
9. INDICATOR PORT OPTION	T	with metal plug	
	W	with plastic plug	when using an indicator
10. INDICATOR	000	no indicator	
	V05	differential visual 5 bar	
	E05	differential electrical 5 bar	
	V08	differential visual 8 bar	
	E08	differential electrical 8 bar	no bypass version only
ACCESSORIES	LC24	LED connector	

The accessories must be ordered separately

PRESSURE DROP (Δp) INFORMATION FOR FILTER SIZING

The total Delta P through a filter assembly is given from Housing Δp + Element Δp .

This ideally should not exceed 1,0 bar and should never exceed 1/3 of the set value of the by-pass valve. N.B. All the reported data have been obtained at our laboratory, according to specification ISO3968 with mineral oil having 32 cSt viscosity and density 0,875 Kg/dm³.

HOUSING PRESSURE DROP

The housing Δp is given by the curve of the considered model and port, in correspondence of the flow rate value.

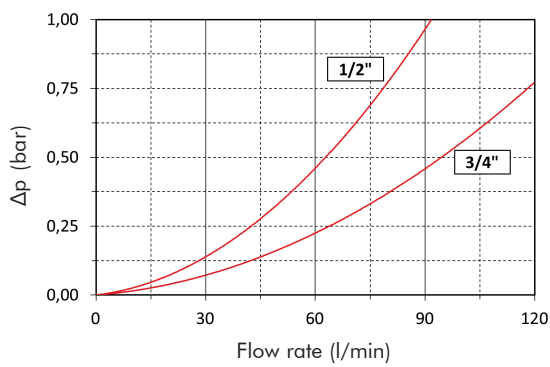
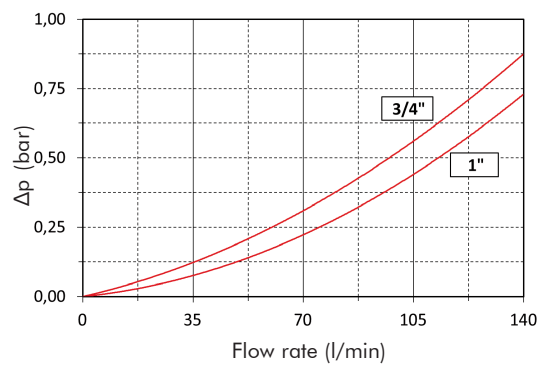
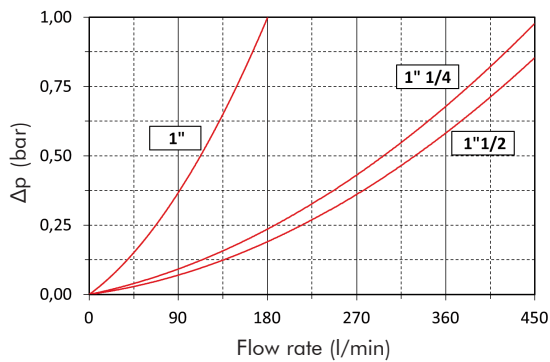
F420 D11xx

F420 D12xx

F420 D14xx

ELEMENT PRESSURE DROP (filter elements 21 bar collapse)

The element Δp (bar) is given by the flow rate (l/min) multiplied by the factor in the table here below corresponding to the selected media and divided by 1000.

If the oil has a viscosity V_x different than 32 cSt a corrective factor $V_x/32$ must be applied.

Example: 80 l/min with D121G10A and oil viscosity 46 cSt $> 80 \times 4,91/1000 \times 46/32 = 0,56$ bar

	G03A	G06A	G10A	G15A	G25A	C10A
D110	89,35	42,24	23,46	15,40	13,11	6,89
D111	59,98	31,32	18,03	10,20	9,46	5,81
D112	26,67	12,93	9,14	5,64	5,20	3,54
D120	30,43	15,52	9,32	5,75	5,31	3,74
D121	15,48	7,54	4,91	3,75	3,25	2,15
D124	19,90	9,35	5,74	4,62	4,00	2,49
D140	14,65	7,48	4,58	3,12	2,95	1,74
D141	6,88	3,31	2,24	1,58	1,34	0,94
D142	4,67	2,21	1,51	1,15	0,92	0,58
D143	3,28	1,40	0,78	0,62	0,44	0,18

EXAMPLE OF TOTAL Δp CALCULATION

F420D121G10ABB5DWV05 with 80 l/min and oil 46 cSt:

Housing Δp 0,3 bar + element Δp 0,56 bar ($80 \times 4,91/1000 \times 46/32$) = total assembly Δp 0,86 bar

ELEMENT PRESSURE DROP (filter elements 210 bar collapse)

The element Δp (bar) is given by the flow rate (l/min) multiplied by the factor in the table here below corresponding to the selected media and divided by 1000.

If the oil has a viscosity V_x different than 32 cSt a corrective factor $V_x/32$ must be applied.

Example: 80 l/min with D121G10B and oil viscosity 46 cSt $> 80 \times 5,61/1000 \times 46/32 = 0,65$ bar

	G03B	G06B	G10B	G15B	G25B
D110	111,11	55,56	35,71	25,61	15,50
D111	51,28	31,81	19,00	13,75	9,54
D112	28,51	13,00	9,25	7,00	5,30
D120	37,18	16,41	12,86	7,65	6,81
D121	23,89	12,50	5,83	4,28	3,71
D124	24,56	12,63	7,37	5,48	4,36
D140	18,57	10,70	5,61	4,16	3,70
D141	10,22	4,44	2,85	1,95	1,60
D142	5,53	3,25	1,85	1,24	0,86
D143	4,59	2,00	1,22	1,03	0,78

EXAMPLE OF TOTAL Δp CALCULATION

F420D121G10BBB5DWV08 with 80 l/min and oil 46 cSt :

Housing Δp 0,3 bar + element Δp 0,65 bar ($80 \times 5,61/1000 \times 46/32$) = total assembly Δp 0,95 bar



BYPASS VALVE PRESSURE DROP

The bypass valve Δp is given by the curve of the considered model and setting, in correspondence of the flow rate value.

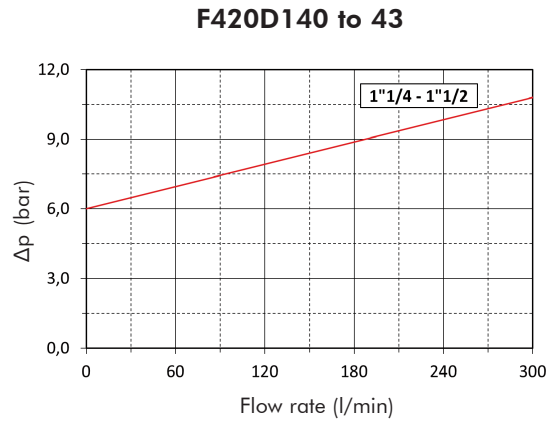
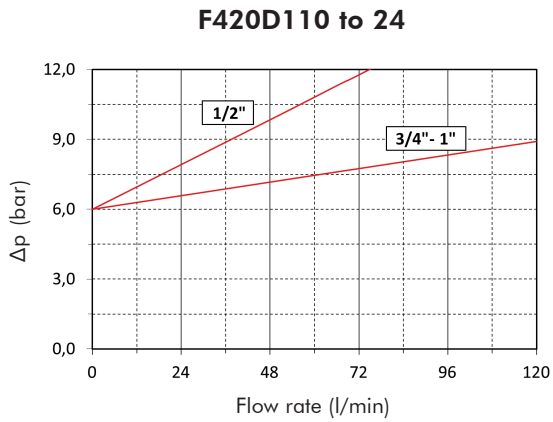

N.B. All the reported data have been obtained at our laboratory, according to specification ISO3968 with mineral oil having 32 cSt viscosity and density 0,875 Kg/dm³.

USER TIPS



- 1 FILTER HEAD
- 2 INDICATOR PORT
- 3 FIXING HOLES
- 4 BY-PASS VALVE
- 5 FILTER ELEMENT
- 6 FILTER BOWL
- 7 SEAL KIT
- 8 IDENTIFICATION LABEL

INDICATOR TIGHTENING TORQUE

V05/E05/V08/E08	50 Nm
-----------------	-------

SPARE SEAL KIT PART NUMBER

	NBR	FKM
F420-D1-10	06.021.00090	06.021.00135
F420-D1-20/30	06.021.00131	06.021.00136
F420-D1-40/50	06.021.00095	06.021.00137

BOWL TIGHTENING TORQUE

F420-D1-10	65 Nm
F420-D1-20/30	75 Nm
F420-D1-40/50	90 Nm



WARNING

-  Make sure that Personal Protective Equipment (PPE) is worn during installation and maintenance operation.

DISPOSAL OF FILTER ELEMENT

-  The used filter elements and the filter parts dirty of oil are classified as "Dangerous waste material": they must be disposed according to the local laws by authorized Companies.



INSTALLATION

-  1. the IN and OUT ports must be connected to the hoses in the correct flow direction (an arrow shows on the filter head (1))
- 2. the filter housing should be preferably mounted with the bowl (6) downward
- 3. secure to the frame the filter head (1) using the threaded fixing holes (3)
- 4. verify that no tension is present on the filter after mounting
- 5. enough space must be available for filter element replacement
- 6. the visual clogging indicator must be in a easily viewable position
- 7. when a electrical indicator is used, make sure that it is properly wired
-  8. never run the system with no filter element fitted
- 9. keep in stock a spare FILTREC filter element for timely replacement when required

OPERATION

-  1. the filter must work within the operating conditions of pressure, temperature and compatibility given in the first page of this data sheet
- 2. the filter element must be replaced as soon as the clogging indicator signals at working temperature (in cold start conditions, oil temperature lower than 30°C, a false alarm can be given due to oil viscosity)
- 3. If no clogging indicator is mounted, replace the element according to the system manufacturer's recommendations

MAINTENANCE

-  1. make sure that the system is switched off and there is no residual pressure in the filter
- 2. unscrew the bowl (6) by turning it anti-clockwise and remove it
- 3. remove the dirty element (5)
- 4. fit a new FILTREC element (5), verifying the part number, particularly concerning the micron rating; open its plastic protection on the open end side and insert it onto the spigot in the filter head, then remove completely the plastic protection
- 5. clean carefully the bowl; check the O-rings (7) conditions and replace if necessary
- 6. lubricate the bowl's thread (6) and screw it by hand in the filter head (1) by turning it clockwise
- 7. screw in the bowl to stop
-  8. the used filter elements cannot be cleaned and re-used



1800-OILSOL <https://oilsolutions.com.au/>
1800-645765

sales@oilsolutions.com.au



1800-OILSOL
1800-645765

<https://oilsolutions.com.au/>

sales@oilsolutions.com.au

