

Range of Products

Detailed Release

Overview

E0.000.0918.15.00IM06

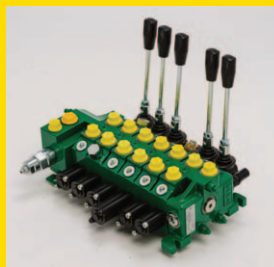
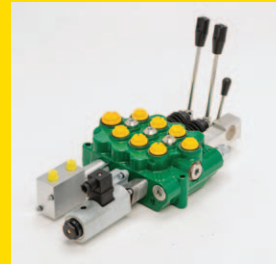



Applications

Mini loader



Hydraulic bushcutter

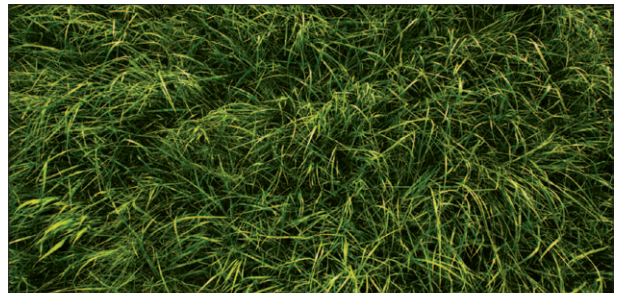

Backhoe loader

Forest crane

Cable hoist



Telescopic handler

Aerial Working Platform

Material handling



Garbage Truck



GENERAL CONSTRUCTIVE FEATURES

- Cast-iron monoblock construction.
- Steel spools, hardened and nickel plated.

GENERAL FUNCTIONAL FEATURES

- Several types of spools: double and single acting, motor spool, float position, regenerative position, etc.
- Several spool control devices and spool positioning devices.
- Power beyond (HPCO) configuration.
- Spool with overcenter valve built-in and hydraulic kick-out built-in.



VDM6/VDM065

- Parallel circuit with single load check valve on pressure "P" line.
- Tandem circuit.
- On-off electric control with manual override.
- Emergency unloading valve.

VDM6A

- Monoblock construction with sectional concept.
- Parallel circuit, load check valve protection on each section.
- Auxiliary valve either on port A or B or on both.
- Single/double acting conversion port valve.
- Electric carry over.



VDM07

- Parallel circuit with load check valve on pressure "P" line.
- Auxiliary valve on B port or relief valve on neutral line that can unload both the ports.



VDM8

- Monoblock construction with sectional concept.
- Parallel circuit, load check valve protection on each section.
- Auxiliary valve either on port A or B or on both.
- On-off electric control with manual override.
- Emergency unloading valve.



TYPE	Nominal Flow		Max. Flow		Operating Pressure		Max. Operating Pressure						Nr of Sections	Circuit*
	l/min	US gpm	l/min	US gpm	bar	psi	P		A/B		T			
VDM6	45	12	60	16	350	5070	350	5070	350	5070	25	360	1 ÷ 7	P / S ⁽¹⁾ / T ⁽²⁾
VDM6A	45	12	60	16	350	5070	350	5070	350	5070	25	360	1 ÷ 7	P
VDM065	60	16	75	20	350	5070	350	5070	350	5070	25	360	1 ÷ 7	P
VDM07	50	14	65	17	315	4560	315	4560	315	4560	20	300	1 ÷ 6	P
VDM8	75	20	90	24	350	5070	350	5070	350	5070	25	360	1 ÷ 5	P

* P = Parallel / S = Series / T = Tandem

(1) Tandem circuit available only on the first working section of the 2, 3, 4, 5 and 6 working sections monoblocks.

(2) Series circuit only on the first working section of the 2, 3, 4, 5 and 6 working sections monoblocks. Series realized inside the spool.

INLET VALVES		VDM6	VDM065	VDM6A	VDM07	VDM8																
Direct		•	•	•	•	•																
Pilot						•																
Unload		•	•	•		•																
AUXILIARY VALVES																						
Overload				•	•	•																
Overload and Anticavitation				•		•																
Anticavitation				•	•	•																
Conversion				•	•	•																
Unidirectional Mechanical				•																		
Unidirectional Piloted																						
SPOOL CONTROLS																						
Mechanical		•	•	•	•	•																
Hydraulic		•		•	•	•																
Pneumatic		•		•	•	•																
Direct Electric		•	•	•	•	•																
Electro-Hydraulic						•																
Electro-Pneumatic		•		•	•	•																
SPOOL POSITIONINGS																						
Spring Return		•	•	•	•	•																
Detent		•	•	•	•	•																
Float		•	•	•	•	•																
Microswitch/Potentiometer Device		•	•	•	•	•																
Torque Limiting				•		•																
Detent with Hydraulic Kick-Out		•	•		•	•																
TYPES OF PORTS AND THREADS		P	PL	P3	T	TL1	TLA/B	P	PL	P3	T	TL1	TLA/B	P	T	TLA/B	P	PL	P3	T	TLA/B	
BSP (UNI ISO 1179 - THREADS UNI ISO 228/1)	G3/8	•	•	•	S	•	•	•	•	•	•	•	•	•	•	•	•	•	•	•	•	•
	G1/2	S	S		•	•		•	•	•	•	•	•	S	S	•	•	S		•	•	•
	G3/4													S		S		S	S	•	•	
BSPF - JIS B 2351-1 (UNI EN ISO 8434-1)	G3/8	•	•	•		•	•				•	•	•	•	•	•						
	G1/2				•	•					•	•	•			•		S			S	
	G3/4																S	S		S	S	
METRIC ISO 262 (UNI EN ISO 9974-1 - THREADS UNI ISO 262)	M18x1,5	•	•	•		•	•				•	•	•	•	•	•						
	M22x1,5				•	•					•	•	•			•		•	•	•		•
	M27x2																				•	•
METRIC ISO 6149 (UNI EN ISO 6149- 1-2-3)	M18x1,5	•	•	•		•	•				•	•	•	•	•	•	•					
	M22x1,5				•	•					S	•	•	•		•		•	•	•		•
	M27x2																				•	•
SAE UN-UNF (UNI ISO 11926 - THREADS UNI ISO 725)	SAE6 (9/16-18 UNF)	S					S	S	S	S	S	S	S	S								
	SAE8 (3/4-16 UNF)	•	•	•	S	•	S	•	S	S	S	S	S	S	•	•	•	S	•	•	•	•
	SAE10 (7/8-14 UNF)				•	•		•	•	•	•	•	•	S	•		•		•	•	•	•
	SAE12 (1-1/16-12 UN)																				•	•

• = Standard / S = Special

E0.000.0918.15.001M06



GENERAL CONSTRUCTIVE FEATURES

- Cast-iron construction.
- Steel spools, hardened and nickel plated.

GENERAL FUNCTIONAL FEATURES

- Parallel, tandem and series circuit available.
- Load check valve protection on each section.
- Auxiliary valve either on port A or B or on both.
- Power beyond (HPCO) configuration.
- Several types of spool: double and single acting, motor spool, float position, regenerative position, etc.
- Several spool control devices and spool positioning devices.



VD6A

- Inlet with built-in pressure compensated priority flow control valve.
- On-off electric control with manual override.
- Emergency unloading valve.
- Spool with overcenter valve built-in and hydraulic kick-out built-in.
- Wide range of mid inlet modules.



VD8A

- Inlet module with priority flow valve adjustable by a pressure signal.
- Priority flow available to supply a power steering unit.
- Single or Biblock construction available.
- On-off electric control with manual override.
- Spool with overcenter valve built-in and hydraulic kick-out built-in.
- Wide range of mid inlet modules.



VD10A

- Modular construction up to 10 sections.
- Parallel, tandem and series circuit available.
- Load check valve protection on each section.
- Auxiliary valves available on ports A and B.



VD12A

- Modular construction up to 10 sections.
- Parallel, tandem and series circuit available.
- Load check valve protection on each section.
- Auxiliary valves available on ports A and B.



TYPE	Nominal Flow		Max. Flow		Operating Pressure		Max. Operating Pressure						Nr of Sections	Circuit
	l/min	US gpm	l/min	US gpm	bar	psi	P		A/B		T			
							bar	psi	bar	psi	bar	psi		
VD6A	45	12	60	16	350	5070	350	5070	350	5070	25	360	1 ÷ 8 ⁽¹⁾	P / S / T
VD8A	75	20	90	24	350	5070	350	5070	350	5070	25	360	1 ÷ 8 ⁽¹⁾	P / S / T
VD10A	120	32	140	37	280	4060	280	4060	315	4560	25	360	1 ÷ 8 ⁽¹⁾	P / S / T
VD12A	180	48	240	63	280	4060	280	4060	315	4560	25	360	1 ÷ 8 ⁽¹⁾	P / S / T

(1) For more working sections please contact our sales department.

INLET VALVES		VD6A				VD8A				VD10A				VD12A													
Direct		•				•				•				•													
Pilot						•				•				•													
Unload		•				•				•				•													
AUXILIARY VALVES																											
Overload		•				•				•				•													
Overload and Anticavitation		•				•				•				•													
Anticavitation		•				•				•				•													
Conversion		•				•																					
Unidirectional Mechanical		•																									
Unidirectional Piloted																											
CONTROLS																											
Mechanical		•				•				•				•													
Hydraulic		•				•				•				•													
Pneumatic		•				•				•				•													
Direct Electric		•				•																					
Electro-Hydraulic		•				•				•				•													
Electro-Pneumatic		•				•				•				•													
SPOOL POSITIONINGS																											
Spring Return		•				•				•				•													
Detent		•				•				•				•													
Float		•				•				•				•													
Microswitch/Potentiometer Device		•				•				•				•													
Torque Limiting		•				•																					
Detent with Hydraulic Kick-Out		•				•				•				•													
TYPES OF PORTS AND THREADS		P	PL	P3	T	TL1	TL	A/B	P	PL	P3	T	TL1	TL	A/B	P	PL	P3	T	TL	A/B	P	PL	P3	T	TL	A/B
BSP (UNI ISO 1179 - THREE- ADS UNI ISO 228/1)	G3/8	•	•	•	S	•	•																				
	G1/2				•	•	S*	•	•	•					•												
	G3/4								•			•	•	S	•	•	•			•							
	G1															•			•	•	•	•	•	•	•	•	•
BSPF - JIS B 2351-1 (UNI EN ISO 8434-1)	G3/8	•	•	•		•	•																				
	G1/2				•	•		•	•	•				•													
	G3/4										•		•														
	G1																										
METRIC ISO 262 (UNI EN ISO 9974-1 - THREADS UNI ISO 262)	M18x1,5	•	•	•		•	•																				
	M22x1,5				•	•		•	•	•				•													
	M27x2										•		•														
METRIC ISO 6149 (UNI EN ISO 6149-1- 2-3)	M18x1,5	•	•	•		•	•																				
	M22x1,5				•	•		•	•	•				•													
	M27x2										•		•														
SAE UN-UNF (UNI ISO 11926 - THREADS UNI ISO 725)	SAE6 (9/16-18 UNF)							S																			
	SAE8 (3/4-16 UNF)	•	•	•		•	•							S													
	SAE10 (7/8-14 UNF)				•	•		•	•	•				•													
	SAE12 (1-1/16-12 UN)										•		•		•	•	•			•							
	SAE16 (1-5/16-12 UN)																			•			•	•	•	•	•

• = Standard/S= Special/S*= Special, max pressure= 280 bar / 4060 psi.

E0.000.0918.15.001M06



GENERAL CONSTRUCTIVE FEATURES

- Cast iron sectional and biblock construction.
- Steel spools, hardened and nickel plated.

GENERAL FUNCTIONAL FEATURES

- Electro-Hydraulic open loop on-off and proportional control (12 or 24 Vdc).
- Parallel circuit with load check valve on every section.
- Several types of spools: double and single acting, motor spool, regenerative position, etc.
- Emergency command button.
- Hand lever.
- Power beyond (HPCO) configuration.
- Availability of auxiliary valves either on port A or B or on both.
- Spool positioning sensor.



- ⊕ Assemblable with VD8A standard sections
- ⊕ Electro-Hydraulic control version
- ⊕ On-Off and Proportional controls
- ⊕ Compact dimensions
- ⊕ No need of external pilot lines

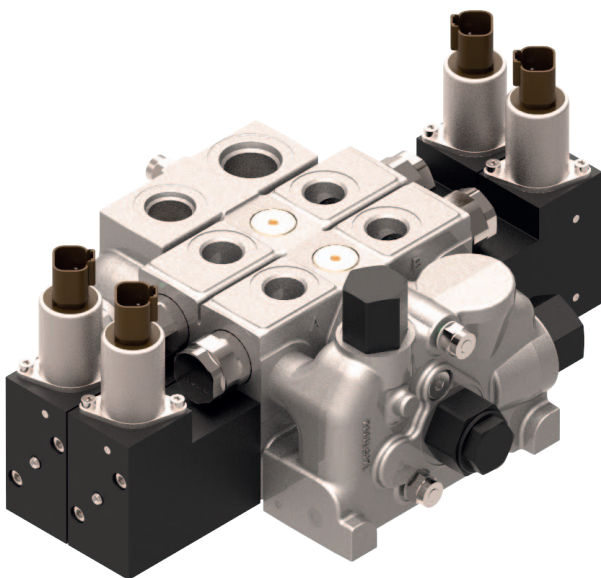

VD8Z

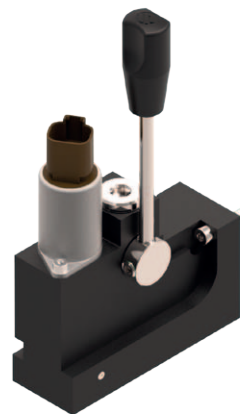

Hand lever available

Example of hydraulic circuit

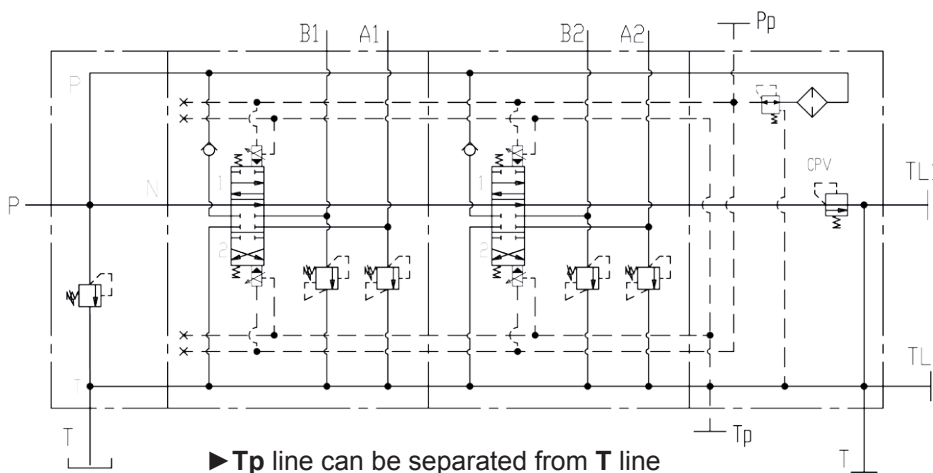

E0.000.0918.15.00IM06



TYPE	Nominal Flow		Max. Flow		Operating Pressure		Max. Operating Pressure						Nr of Sections	Circuit*
	l/min	US gpm	l/min	US gpm	bar	psi	P		A/B		T			
VD8Z	75	20	90	24	350	5070	bar	psi	bar	psi	bar	psi	1 ÷ 8	P

* P = Parallel

INLET VALVES				VD8Z										
Direct				•										
Pilot				•										
Unload				•										
AUXILIARY VALVES														
Overload				•										
Overload and Anticavitation				•										
Anticavitation				•										
Conversion				•										
Unidirectional Mechanical														
Unidirectional Piloted														
CONTROLS														
Electro-Hydraulic On/Off				•										
Electro-Hydraulic Proportional				•										
Electro-Hydraulic On/Off with Lever				•										
Electro-Hydraulic Proportional with Lever				•										
SPOOL POSITIONINGS														
Spring Return				•										
Spool position sensor				•										
TYPES OF PORTS AND THREADS				P	PL	P3/T3	T	TL1*	TL	A/B	Pp	TP		
BSP (UNI ISO 1179 - THREADS UNI ISO 228/1)	G1/4										•	•		
	G1/2			•	•	•				•				
	G3/4			•			•	•	•	S				
BSPF - JIS B 2351-1 (UNI EN ISO 8434-1)	G1/4										•	•		
	G1/2			•	•	•				•				
	G3/4						•	•	•					
METRIC ISO 262 (UNI EN ISO 9974-1 - THREADS UNI ISO 262)	M22x1,5			•	•	•				•				
	M27x2						•	•	•					
	G1/4										•	•		
METRIC ISO 6149 (UNI EN ISO 6149-1-2-3)	M22x1,5			•	•	•				•				
	M27x2						•	•	•					
	G1/4										•	•		
SAE UN-UNF (UNI ISO 11926 - THREADS UNI ISO 725)	SAE4 (7/16-20 UNF)										•	•		
	SAE8 (3/4-16 UNF)									S				
	SAE10 (7/8-14 UNF)			•	•	•				•				
	SAE12 (1-1/16-12 UN)						•	•	•					
ELECTRICAL DATA														
Voltage				12V					24V					
Current				1500 mA					750 mA					
Resistance				4.72 Ω ± 5%					20.8 Ω ± 5%					
Type of control				On/Off					Proportional					
				Direct Current 12 and 24 V					Current control/PWM 100 Hz recommended					
Connector				AMP Junior Timer/Deutsch Connector DT04-2P/Flying Leads										

• = Standard/S = Special/TL1* = Port available instead of CPV valve, ensure at least 10 bars on T line to guarantee the Electro-Hydraulic modules function.

EO.000.0918.15.001M06



GENERAL CONSTRUCTIVE FEATURES

- Cast-iron construction (inlet section, working section, outlet section).
- Steel spools, hardened and nickel plated.

GENERAL FUNCTIONAL FEATURES

- Load Sensing directional control valve.
- Available with inlet module for fixed or variable displacement pump.
- Inlet module with built-in pressure compensator.
- Mechanical, pneumatic, hydraulic controls available.
- Electro-Hydraulic open loop on-off and proportional control available (12 or 24 Vdc).
- Range of spool sizes for different flow.
- Availability of venting valve into inlet section.
- Availability of auxiliary valves either on port A or B or on both.
- Several types of spool: double, single acting, motor spool, float position etc.

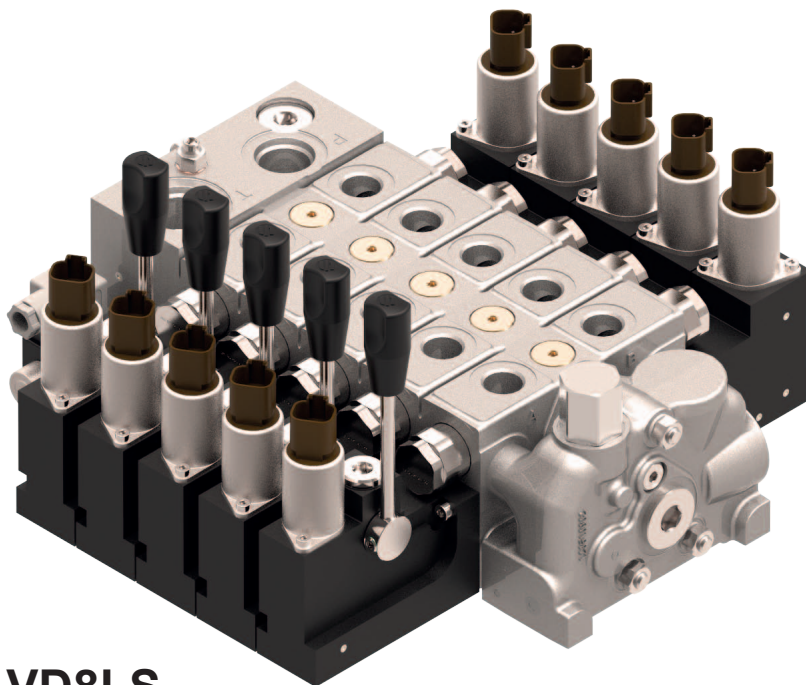

VD8LS

- + Open and closed center inlet sections
- + Mechanical, pneumatic and hydraulic controls
- + Electro-hydraulic On/Off and proportional controls
- + Compact dimensions

Inlet section for variable displacement pumps

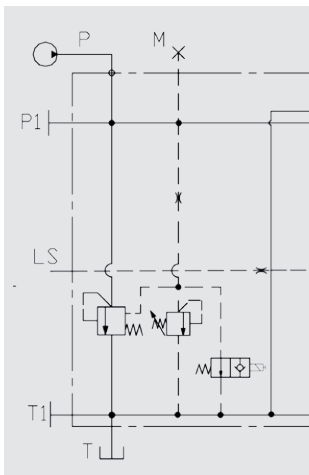

Inlet section for fixed displacement pumps

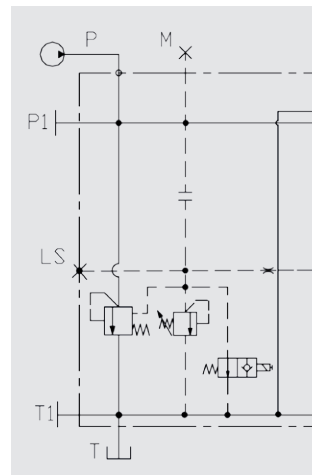

Example of hydraulic circuit

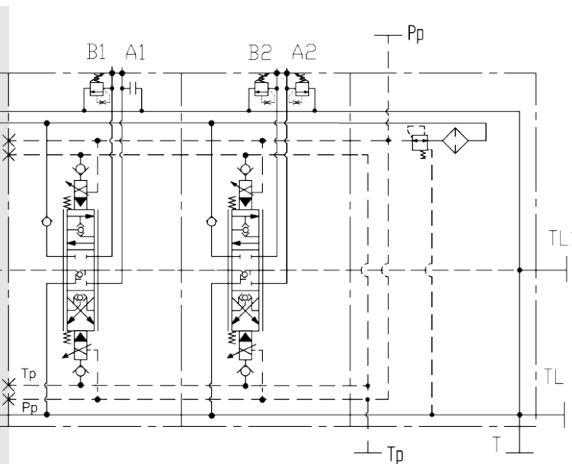

E0.000.0918.15.00IM06



	Max. Flow				Operating Pressure		Max. Operating Pressure						Nr of Sections	Circuit*
	P		A/B				P		A/B		T			
TYPE	l/min	US gpm	l/min	US gpm	bar	psi	bar	psi	bar	psi	bar	psi		
VD8LS	130	34	100	26	350	5070	350	5070	350	5070	25	360	1 ÷ 8	P

* P = Parallel

INLET VALVES							VD8LS							
Direct							•							
Pilot							•							
Unload							•							
AUXILIARY VALVES														
Overload							•							
Overload and Anticavitation							•							
Anticavitation							•							
Conversion							•							
Unidirectional Mechanical														
Unidirectional Piloted														
CONTROLS														
Mechanical							•							
Hydraulic							•							
Pneumatic							•							
Electro-Hydraulic On/Off							•							
Electro-Hydraulic Proportional							•							
Electro-Hydraulic On/Off with Lever							•							
Electro-Hydraulic Proportional with Lever							•							
SPOOL POSITIONINGS														
Spring Return							•							
Spool position sensor							•							
TYPES OF PORTS AND THREADS							P	PL	T	TL1	TL	A/B	Pp	Tp
BSP (UNI ISO 1179 - THREADS UNI ISO 228/1)	G1/4												•	•
	G1/2						•	•				•		
	G3/4						•		•	•	•	S		
BSPF - JIS B 2351-1 (UNI EN ISO 8434-1)	G1/4												•	•
	G1/2						•	•				•		
	G3/4								•	•	•			
METRIC ISO 262 (UNI EN ISO 9974-1 - THREADS UNI ISO 262)	M22x1,5						•	•				•		
	M27x2								•	•	•			
	G1/4												•	•
METRIC ISO 6149 (UNI EN ISO 6149-1-2-3)	M22x1,5						•	•				•		
	M27x2								•	•	•			
	G1/4												•	•
SAE UN-UNF (UNI ISO 11926 - THREADS UNI ISO 725)	SAE4 (7/16-20 UNF)												•	•
	SAE8 (3/4-16 UNF)											S		
	SAE10 (7/8-14 UNF)						•	•				•		
	SAE12 (1-1/16-12 UN)								•	•	•			
ELECTRICAL DATA														
Voltage					12V					24V				
Current					1500 mA					750 mA				
Resistance					4.72 Ω ± 5%					20.8 Ω ± 5%				
Type of control					On/Off					Proportional				
					Direct Current 12 and 24 V					Current control/PWM 100 Hz recommended				
Connector					AMP Junior Timer/Deutsch Connector DT04-2P/Flying Leads									

•= Standard/S= Special

E0.000.0918.15.001M06



GENERAL CONSTRUCTIVE FEATURES

- Cast-iron construction (inlet section, working section, outlet section).
- Steel spools, hardened and nickel plated.

GENERAL FUNCTIONAL FEATURES

- Proportional Load Independent, Load Sensing control valve
- Available with inlet module for variable displacement pump and fixed displacement pump (with built-in pressure compensator).
- Availability of venting valve.
- Several types of spool: double, single acting, motor spool, float position etc.
- Working modules with built-in pressure compensator.
- Electro-Hydraulic open loop on-off, proportional control available (12 or 24 Vdc).
- Closed loop electro-hydraulic proportional control available in analog or CANBUS version.
- Handle, pneumatic, hydraulic controls available.
- Availability of auxiliary valves either on port A or B or on both.
- Availability of pressure relief valve on the LS line coming from the ports.

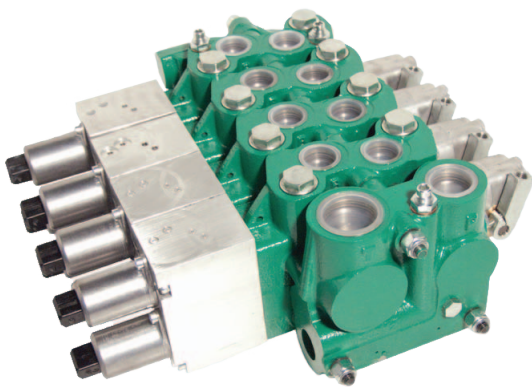

VDP08



JEC

ECS

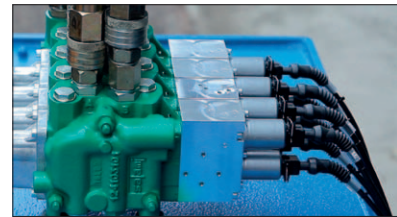

Cable Kit Option

+

Electronic Remote Control Systems (see page 16).

Example of hydraulic circuit

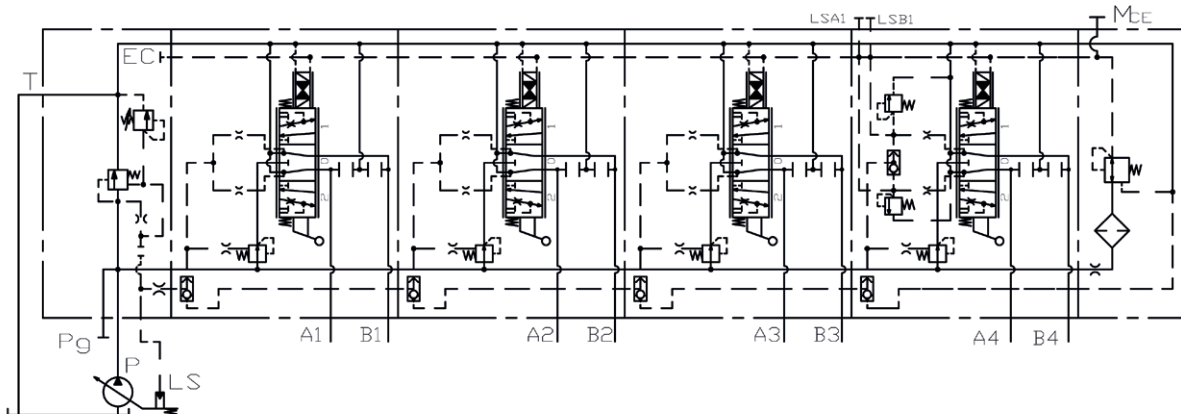

E0.000.0918.15.00IM06



	Max. Flow				Operating Pressure		Max. Operating Pressure						Nr of Sections	Circuit**
	P		A/B				P		A/B		T			
TYPE	l/min	US gpm	l/min	US gpm	bar	psi	bar	psi	bar	psi	bar	psi		
VDP08	130	34	95*	25*	350	5070	350	5070	350	5070	10	145	1 ÷ 8	FDC / CDC

* with compensator.

** FDC = fixed displacement circuit / VDC = variable displacement circuit.

INLET VALVES							VDP08						
Direct													
Pilot							•						
Unload							•						
AUXILIARY VALVES													
Overload													
Overload and Anticavitation							•						
Anticavitation							•						
Conversion													
Unidirectional Mechanical													
Unidirectional Piloted													
CONTROLS													
Mechanical							•						
Hydraulic							•						
Pneumatic							•						
Electro-Hydraulic On/Off							•						
Electro-Hydraulic Proportional open loop							•						
Electro-Hydraulic Proportional closed loop							•						
Electro-Pneumatic							•						
SPOOL POSITIONINGS													
Spring Return							•						
Detent													
Float							•						
Microswitch/Potentiometer Device													
Torque Limiting													
TYPES OF PORTS AND THREADS							P	PL	T	TL	LS	A/B	
BSP (UNI ISO 1179 - THREADS UNI ISO 228/1)	G1/4										•		
	G3/8												
	G1/2						S					•	
	G3/4						•	•	S				
	G1								•	•			
BSPF - JIS B 2351-1 (UNI EN ISO 8434-1)	G3/8												
	G1/2												
	G3/4												
	G1												
METRIC ISO 262 (UNI EN ISO 9974-1 - THREADS UNI ISO 262)	M12x1,5												
	M22x1,5												
	M26x1,5												
	M27x2												
METRIC ISO 6149 (UNI EN ISO 6149-1-2-3)	M12x1,5												
	M22x1,5												
	M27x2												
SAE UN-UNF (UNI ISO 11926 - THREADS UNI ISO 725)	SAE4 (7/16-20 UNF)										•		
	SAE6 (9/16-18 UNF)												
	SAE8 (3/4-16 UNF)												
	SAE10 (7/8-14 UNF)						S					•	
	SAE12 (1-1/16-12 UN)						•	•	S				
	SAE16 (1-5/16-12 UN)								•	•			

•= Standard/S= Special

E0.000.0918.15.001M06



JEC - Joystick Electronic Control

The **JEC system** performs the electronic remote control of electro-hydraulic directional control valves.



- Hall Effect contactless technology.
- Supply voltage: 8 - 32 Vdc.
- Main body material: aluminium.
- Suitable for heavy duty applications.
- Lever deflection angle: $\pm 22^\circ \pm 1^\circ$.
- Operating temperature range: $-25^\circ\text{C} / + 80^\circ\text{C}$.
- Protection class (above panel): up to IP 67.
- Life: > 5 million cycles.
- Multifunction, ergonomic and symmetric handle.
- Single axis (bi-directional movement).
- Dual axes (cross or all diagonals movement).
- Availability to mount dead man push button.
- On-off (using 3 A inductive push buttons) and proportional (using axis movement and rollers) controls available.
- Deutsch connectors.

JEC - PWM version

The PWM version works connecting the appropriate cable kit, coming out from the joystick, at the connectors of the solenoid valves housed on the directional control valve.

In this way the electronic manipulator transfers the current required to operate at solenoid valves end becomes the only controllers of the entire system.



- PWM output: 2 x dual proportional/on-off solenoid valves (control of 2 mechanical sections, 12 or 24 Vdc).
- Availability to mount a roller (with a dedicated PWM driver inside the handle) on the front plate for third proportional function.
- Current output range (PWM): from 100 to 1600 mA.
- Dither frequency: from 60 to 250 Hz (100 Hz factory preset).
- Up to 6 push buttons on the front plate (only if there isn't the roller mounted).
- Up to 3 push buttons on rear plate.
- Joystick connector type: Deutsch DT
- Dedicated cable kit with AMP JT connectors for the connection with solenoid valves.
- Dedicated calibration and configuration tool for setting: Imin, Imax, ramps, duty cycle, dither. frequency
- PWM signals calibration: using an apposite software for PC and a RS232 serial line communication. It is necessary a special programming cable in order to realize the connection between the joystick and the PC.

JEC - CANBus version

Joystick with CAN-BUS output that can connect a large number of commands and transmit them remotely using the CAN-BUS protocol.

It needs an electronic control unit that "translates" the command messages sent to the electro-hydraulic directional control valve.



- Physical layer: ISO 11898, 250Kbit/s.
- Protocol: J1939/ CANOpen.
- Connector type: Deutsch DT04-4P

With Canbus link, following signals can be managed on the grip:

- 4 digital outputs 0.7 A (LEDs, detent coils, buzzers, etc.).
- 6 analog voltage input 0-5 Vdc (proportional rollers).
- 6 digital inputs (push buttons).



ECS - Electronic Control System

The “Electronic Control System - ECS” for hydraulic control valves provides greater flexibility and versatility than mechanical or hydraulic controls. It also allows greater integration between different controls and devices. It is possible to manage from 1 to 8 mechanical sections of an electro-hydraulic directional control valve.



The communication between the joystick and the control unit takes place through a voltage signal or via CAN bus protocol.

The control units are equipped with a standard programming of the working parameters that allows to satisfy the vast majority of applications.

For special applications, you can use a software that lets you edit, via PC and in wireless mode (via Bluetooth), some parameters related to the control of solenoid valves; for example, to define the minimum and maximum values of the linear curves, or the frequency dither for the PWM outputs.

Cables kit configurations are available and depend on how many input/output signals the control unit has to manage.

MAIN TECHNICAL SPECIFICATIONS

ELECTRICAL FEATURES	
<i>Supply Voltage:</i>	8 ÷ 36V
<i>Maximum current supplied:</i>	up to 20A for each connector (40A total)
<i>Electromagnetic certifications:</i>	Emission Test: EN 55011 Class A Immunity Test: EN 61000-4-2,3,6
<i>Protections:</i>	reverse polarity, overvoltage, overcurrent and short circuits
<i>Working temperature:</i>	-40° ÷ 85 °C
<i>Processing unit:</i>	dual 32 bit-CPU
<i>Stockage temperature:</i>	-50° ÷ 125 °C
<i>Number of connectors:</i>	2 (30 + 18 pins)
<i>Number of PWM/ Digital Outputs:</i>	16 outputs programmable as proportional (PWM) or digital (ON/OFF): - up to 5A for digital; - up to 2A for PWM proportional (with 12 bit resolution). High and low side protected with current feedback
<i>Number of Analog / Digital Inputs:</i>	10 (with 12 bit resolution, configurable as digitals, or 4-20mA, or 0-5V, or 0-10V, or ratiometrics)
<i>Communication protocol:</i>	2 independent CAN lines (J1939, CANopen)
<i>Parameters Calibration/ Diagnostics:</i>	Wireless, using “BT 2.1 + EDR” (2.4 GHz) trasmission between ECS (built-in antenna) and a PC with a dedicated software
<i>Auxiliary voltages:</i>	5V, 12V, V _{supply}

MECHANICAL FEATURES	
<i>Operating Temperature:</i>	-40°C to +85°C
<i>Current:</i>	10 Amp @ 85°C
<i>Contact Resistance:</i>	< 10mΩ
<i>Insulation Resistance:</i>	> 1000 MΩ
<i>Sealing:</i>	IP67, IP69K
<i>Temperature Life:</i>	1000 Hrs @ 85°C
<i>Current Cycling:</i>	500Hrs @ 10 Amp 500 cycles 45 min ON – 15 min OFF
<i>Vibration:</i>	10 to 2000 to 10 Hz with 15 g's peak level
<i>Shock</i>	50 g's – 20 pulses
<i>Salt Spray:</i>	96 Hrs
<i>Temperature Humidity Cycling:</i>	320 Hrs. 40 – 8 Hrs cycles -40°C to +85°C
<i>Fluid Resistance:</i>	Resists to most fluids used in industrial applications

E0.000.0918.15.001M06



GENERAL CONSTRUCTIVE FEATURES

- Gear pumps made with aluminium body, cast iron flanges and covers.

GENERAL FUNCTIONAL FEATURES

- High volumetric efficiency achieved by floating bushings and axial compensation.
- 12 teeth integral one piece gear and shaft.
- modular construction.

Note: For bidirectional pump the max pressure has to be reduced by 10%. The max pressure is referred to pumps with flanged ports, using the threaded ports the pump life could be reduced.

1.5PE

- Single shaft seal.
- Rear covers with built-in valves.
- Flanges: European, SAE AA.
- Ports: European, German and American standards.
- Shafts: European and American standards.



** Max speed allowed with P² pressure working continuously at P¹ the max. speed must be reduced by 10%.

TYPE	Displacement		Continuous pressure P ¹		Intermittent pressure P ²		Peak pressure P ³		Min. speed at P ¹	Max. speed at P ^{2**}
	cm ³ /rev	cu.in/rev	bar	psi	bar	psi	bar	psi	min ⁻¹	
1.5PE - 1.4	1.4	0.09	250	3625	270	3915	290	4205	700	5000
1.5PE - 2.1	2.1	0.13	250	3625	270	3915	290	4205	700	5000
1.5PE - 2.8	2.8	0.17	250	3625	270	3915	290	4205	700	4500
1.5PE - 3.5	3.5	0.21	250	3625	270	3915	290	4205	700	4500
1.5PE - 4.1	4.1	0.25	250	3625	270	3915	290	4205	700	4000
1.5PE - 5.2	5.2	0.32	230	3335	250	3625	270	3915	700	4000
1.5PE - 6.2	6.2	0.38	230	3335	250	3625	270	3915	600	3600
1.5PE - 7.6	7.6	0.46	200	2900	220	3190	250	3625	600	3300
1.5PE - 9.3	9.3	0.57	180	2610	200	2900	240	3480	600	3000
1.5PE - 11	11	0.67	170	2465	190	2755	220	3190	600	3000

2PE

- Double shaft seal.
- Outtrigger bearing available.
- Wide range of rear covers with built-in valves.
- Compact design.
- Flanges: European, German, SAE A, SAE B, 4 Bolts
- Ports: European, German and American standards.
- Shafts: European and American standards.



** Max speed allowed with P² pressure working continuously at P¹ the max. speed must be reduced by 10%.

TYPE	Displacement		Continuous pressure P ¹		Intermittent pressure P ²		Peak pressure P ³		Min. speed at P ¹	Max. speed at P ^{2**}
	cm ³ /rev	cu.in/rev	bar	psi	bar	psi	bar	psi	min ⁻¹	
2PE - 3.2*	3.2	0.19	250	3625	280	4060	300	4350	600	4000
2PE - 3.9*	3.9	0.24	250	3625	280	4060	300	4350	600	4000
2PE - 4.5	4.6	0.27	250	3625	280	4060	300	4350	600	4000
2PE - 6.5	6.5	0.4	250	3625	280	4060	300	4350	600	4000
2PE - 8.3	8.2	0.5	250	3625	280	4060	300	4350	500	3500
2PE - 10.5	10.6	0.65	250	3625	280	4060	300	4350	500	3500
2PE - 11.3	11.5	0.68	250	3625	280	4060	300	4350	500	3500
2PE - 12.5	12.7	0.77	250	3625	280	4060	300	4350	500	3500
2PE - 13.8	13.8	0.84	250	3625	280	4060	300	4350	500	3500
2PE - 16	16.6	1.01	250	3625	280	4060	300	4350	400	3000
2PE - 19	19.4	1.15	220	3140	240	3480	260	3750	400	3000
2PE - 22.5	22.9	1.37	200	2900	220	3140	240	3480	400	2750
2PE - 26	25.8	1.58	180	2610	200	2900	220	3190	300	2500

* Available only as rear pump

EO.000.0918.15.00IM06



2.5PB

- Double shaft seal.
- Outrigger bearing available.
- Wide range of rear covers with built-in valves.
- Compact design.
- Flanges: European, SAE A, SAE B, 3 Bolt.
- Ports: European, American standards.
- Shafts: European and American standards.



** Max speed allowed with P² pressure working continuously at P¹ the max. speed must be reduced by 10%.

*Available only as rear pump, displacements 11.5-13.8 are available as single pump only with drive shaft "55"

TYPE	Displacement		Continuous pressure P ¹		Intermittent pressure P ²		Peak pressure P ³		Min. speed at P ¹	Max. speed at P ² **
	cm ³ /rev	cu.in/rev	bar	psi	bar	psi	bar	psi	min ⁻¹	
2.5PB - 5.5*	5.97	0.36	250	3625	280	4060	300	4350	600	3000
2.5PB - 8.3*	8.29	0.5	250	3625	280	4060	300	4350	600	3000
2.5PB - 11.5*	11.76	0.72	250	3625	280	4060	300	4350	600	3000
2.5PB - 13.8*	14.07	0.86	250	3625	280	4060	300	4350	600	3000
2.5PB - 16	16	0.97	250	3625	280	4060	300	4350	600	3000
2.5PB - 19	19.3	1.17	250	3625	280	4060	300	4350	600	3000
2.5PB - 22	22.2	1.35	250	3625	280	4060	300	4350	500	3000
2.5PB - 25	25.2	1.53	250	3625	280	4060	300	4350	500	3000
2.5PB - 28	27.6	1.68	250	3625	280	4060	300	4350	500	3000
2.5PB - 32	32.4	1.97	230	3330	250	3625	260	3750	500	3000
2.5PB - 38	38.1	2.32	200	2900	220	3140	240	3480	400	2750
2.5PB - 44	44.2	2.69	170	2465	190	2755	210	3040	400	2500

3PE

- Double shaft seal.
- Outrigger bearing available.
- Wide range of rear covers with built-in valves.
- Compact design.
- Flanges: European, German standards and SAE B.
- Ports: European, German and American standards.
- Shafts: European and American standards.



** Max speed allowed with P² pressure working continuously at P¹ the max. speed must be reduced by 10%.

TYPE	Displacement		Continuous pressure P ¹		Intermittent pressure P ²		Peak pressure P ³		Min. speed at P ¹	Max. speed at P ² **
	cm ³ /rev	cu.in/rev	bar	psi	bar	psi	bar	psi	min ⁻¹	
3PE - 21	20.6	1.26	250	3625	280	4060	300	4350	600	3000
3PE - 27	27	1.65	250	3625	280	4060	300	4350	600	3000
3PE - 33	33.5	2.04	250	3625	280	4060	300	4350	600	3000
3PE - 38	38.7	2.36	240	3480	260	3750	275	3990	500	2750
3PE - 46	46.9	2.86	250	3625	270	3915	280	4060	500	2750
3PE - 55	54.1	3.3	220	3140	240	3480	250	3625	400	2500
3PE - 65	63.1	3.85	200	2900	220	3140	240	3480	400	2500
3PE - 75	73.4	4.48	180	2610	200	2900	220	3140	400	2500

EO.000.0918.15.001M06



GENERAL CONSTRUCTIVE FEATURES

- Gear pumps made with aluminium body, cast iron flanges and covers.

GENERAL FUNCTIONAL FEATURES

- High volumetric efficiency achieved by floating bushings and axial compensation.
- 12 teeth integral one piece gear and shaft.
- modular construction.

Note: For bidirectional pump the max pressure has to be reduced by 10%. The max pressure is referred to pumps with flanged ports, using the threaded ports the pump life could be reduced.

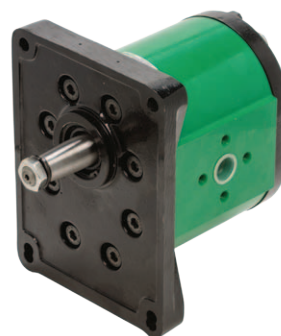

3.5PC

- Double shaft seal.
- Outrigger bearing available.
- Flanges: European, SAE B.
- Ports: European, American standards.
- Shafts: European and American standards.

*** Max speed allowed with P² pressure working continuously at P¹ the max. speed must be reduced by 10%.*

*Available for quantity	TYPE	Displacement		Continuous pressure P ¹		Intermittent pressure P ²		Peak pressure P ³		Min. speed at P ¹	Max. speed at P ^{2**}
		cm ³ /rev	cu.in/rev	bar	psi	bar	psi	bar	psi	min ⁻¹	
	3.5PC - 55	54.8	3.34	250	3625	280	4060	300	4350	400	2750
	3.5PC - 64	63.2	3.85	250	3625	280	4060	300	4350	350	2750
	3.5PC - 75	74.7	4.55	230	3330	250	3625	280	4060	300	2500
	3.5PC - 87	88	5.36	210	3040	230	3330	260	3750	300	2250
	3.5PC - 98*	99	6.03	200	2900	220	3140	250	3625	300	2000



MULTIPLE STAGE CONFIGURATIONS WITH DIFFERENT PUMPS GROUP



2PE/1.5PE

Allowed combination:

one or a multiple 2PE pump assembled with one or a multiple 1.5PE pump, with common or separated suction.



2.5PB/2PE

Allowed combination:

one or a multiple 2.5PB pump assembled with one or a multiple 2PE pump, with common or separated suction.

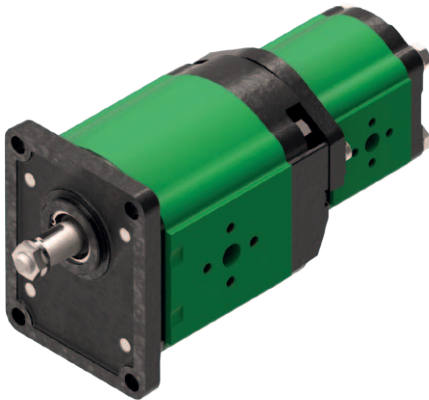

3PE/2PE 3PE/1.5PE

Allowed combination:

one or a multiple 3PE pump assembled with one or a multiple 2PE or 1.5PE pump, with common or separated suction.

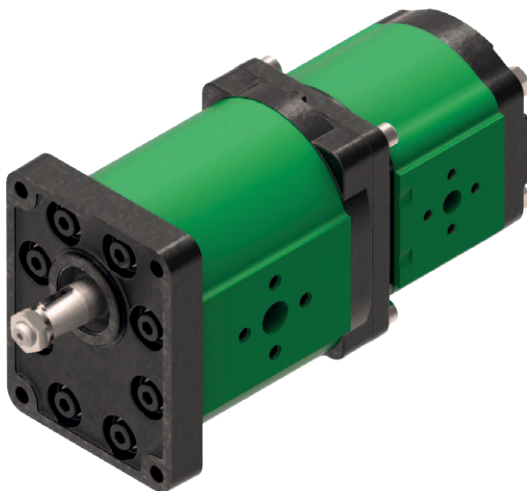

3.5PC/3PE 3.5PC/2PE

Allowed combination:

one or a multiple 3.5PC pump assembled with one or a multiple 3PE or 2PE pump, with common or separated suction.



GENERAL CONSTRUCTIVE FEATURES

- Gear pumps made with aluminium body, cast iron flanges and covers.

GENERAL FUNCTIONAL FEATURES

- Low Noise emissions.
- High volumetric efficiency achieved by floating bushings and axial compensation.
- 12 teeth integral one piece gear and shaft.
- modular construction.

Note: For bidirectional pump the max pressure has to be reduced by 10%. The max pressure is referred to pumps with flanged ports, using the threaded ports the pump life could be reduced.

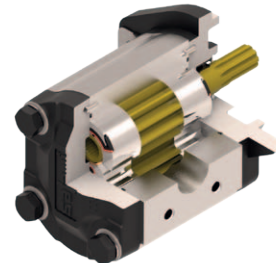

2PW

- Double shaft seal.
- Outrigger bearing available.
- Wide range of rear covers with built-in valves.
- Compact design.
- Flanges: European, German, SAE A, SAE B, 4 Bolts.
- Ports: European, German and American standards.
- Shafts: European and American standards.
- Double flank engagement to reduce pressure pulsation.

** Max speed allowed with P² pressure working continuously at P¹ the max. speed must be reduced by 10%.

TYPE	Displacement		Continuous pressure P ¹		Intermittent pressure P ²		Peak pressure P ³		Min. speed at P ¹	Max. speed at P ^{2**}
	cm ³ /rev	cu.in/rev	bar	psi	bar	psi	bar	psi		
2PW - 3.2*	3.2	0.19	250	3625	280	4060	300	4350	600	4000
2PW - 3.9*	3.9	0.24	250	3625	280	4060	300	4350	600	4000
2PW - 4.5	4.6	0.27	250	3625	280	4060	300	4350	600	4000
2PW - 6.5	6.5	0.4	250	3625	280	4060	300	4350	600	4000
2PW - 8.3	8.2	0.5	250	3625	280	4060	300	4350	500	3500
2PW - 10.5	10.6	0.65	250	3625	280	4060	300	4350	500	3500
2PW - 11.3	11.5	0.68	250	3625	280	4060	300	4350	500	3500
2PW - 12.5	12.7	0.77	250	3625	280	4060	300	4350	500	3500
2PW - 13.8	13.8	0.84	250	3625	280	4060	300	4350	500	3500
2PW - 16	16.6	1.01	250	3625	280	4060	300	4350	400	3000
2PW - 19	19.4	1.15	220	3140	240	3480	260	3750	400	3000
2PW - 22.5	22.9	1.37	200	2900	220	3140	240	3480	400	2750
2PW - 26	25.8	1.58	180	2610	200	2900	220	3190	300	2500

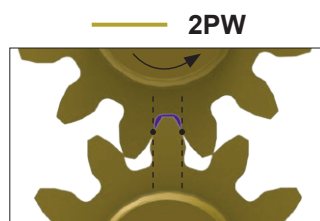

Low Noise gear pump

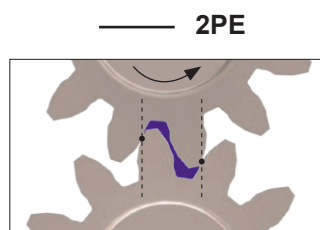

Standard gear pump

Pressure Ripple

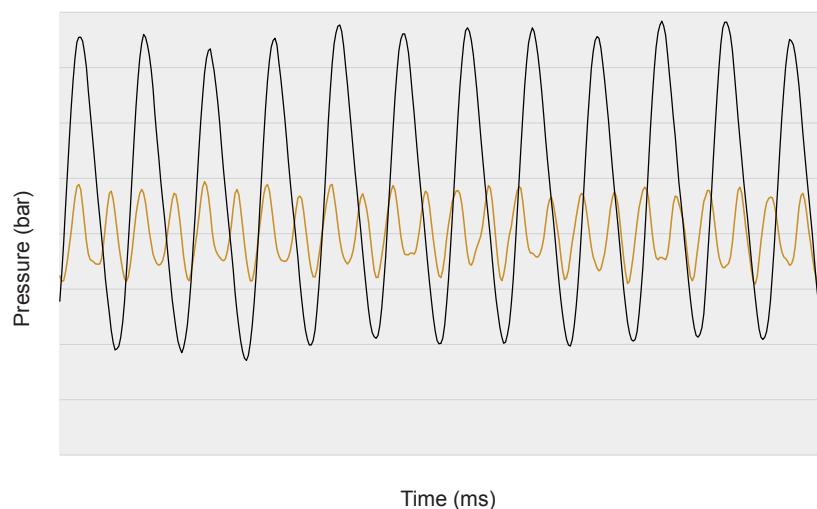

E0.000.0918.15.00IM06



2PZ

- 12 teeth offset split gear construction.
- Double shaft seal.
- Outrigger bearing available.
- Wide range of rear covers with built-in valves.
- Flanges: European, German, SAE A, SAE B, 4 Bolts
- Ports: European, German and American standards.
- Shafts: European and American standards.

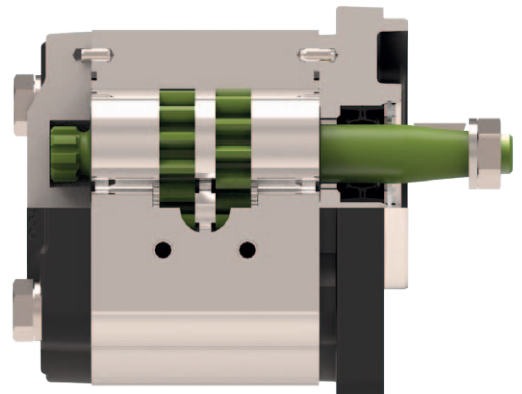

** Max speed allowed with P² pressure working continuously at P¹ the max. speed must be reduced by 10%.

TYPE	Displacement		Continuous pressure P ¹		Intermittent pressure P ²		Peak pressure P ³		Min. speed at P ¹	Max. speed at P ² **
	cm ³ /rev	cu.in/rev	bar	psi	bar	psi	bar	psi		
2PZ - 5	5	0.30	220	3190	250	3625	275	3990	600	4000
2PZ - 8	8	0.49	220	3190	250	3625	275	3990	600	4000
2PZ - 11	10.9	0.66	220	3190	250	3625	275	3990	500	3500
2PZ - 14	13.9	0.85	220	3190	250	3625	275	3990	500	3500
2PZ - 16	16	0.98	210	3040	230	3330	250	3625	400	3000
2PZ - 19	19	1.16	190	2755	210	3040	230	3330	400	3000
2PZ - 22.5	22.5	1.37	180	2610	200	2900	220	3190	400	2750

Pressure Ripple

2PZ ———
2PE ———



Time (ms)



GENERAL CONSTRUCTIVE FEATURES

- Gear motors made with aluminium body, cast iron flanges and covers.

GENERAL FUNCTIONAL FEATURES

- High volumetric efficiency achieved by floating bushings and axial compensation.
- 12 teeth integral one piece gear and shaft.
- modular construction.

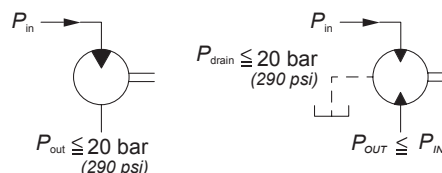

The Motors are equipped with HPD shaft seal (20bar), on request is available also for motor with outrigger bearing. Max drain pressure is influenced by rotational speed of the unit.

1.5ME

- Single shaft seal.
- Rear covers with built-in valves.
- Flanges: European, SAE AA.
- Ports: European, German and American standards.
- Shafts: European and American standards.



TYPE	Displacement		Max. continuous pressure P ¹		Max. starting pressure P ²		Min. speed at P ¹	Max. speed at P ²
	cm ³ /rev	cu.in/rev	bar	psi	bar	psi		
1.5ME - 2.8	2.8	0.17	250	3625	270	3915	700	4500
1.5ME - 3.5	3.5	0.21	250	3625	270	3915	700	4500
1.5ME - 4.1	4.1	0.25	250	3625	270	3915	700	4000
1.5ME - 5.2	5.2	0.32	230	3335	250	3625	700	4000
1.5ME - 6.2	6.2	0.38	230	3335	250	3625	600	3600
1.5ME - 7.6	7.6	0.46	200	2900	220	3190	600	3300
1.5ME - 9.3	9.3	0.57	180	2610	200	2900	600	3000
1.5ME - 11	11	0.67	170	2465	190	2755	600	3000

2ME

- Double shaft seal.
- Outrigger bearing available.
- Wide range of rear covers with built-in valves.
- Flanges: European, German, SAE A, SAE B, 4 Bolts
- Ports: European, German and American standards.
- Shafts: European and American standards.



TYPE	Displacement		Max. continuous pressure P ¹		Max. starting pressure P ²		Min. speed at P ¹	Max. speed at P ²
	cm ³ /rev	cu.in/rev	bar	psi	bar	psi		
2ME - 4.5	4.6	0.27	250	3625	280	4060	600	4000
2ME - 6.5	6.5	0.4	250	3625	280	4060	600	4000
2ME - 8.3	8.2	0.5	250	3625	280	4060	500	3600
2ME - 10.5*	10.6	0.65	250	3625	280	4060	500	3500
2ME - 11.3	11.5	0.68	250	3625	280	4060	500	3500
2ME - 12.5*	12.7	0.77	250	3625	280	4060	500	3400
2ME - 13.8	13.8	0.84	250	3625	280	4060	500	3400
2ME - 16	16.6	1.01	250	3625	280	4060	450	3200
2ME - 19	19.4	1.15	220	3140	240	3480	450	3200
2ME - 22.5	22.9	1.37	200	2900	220	3140	450	3000
2ME - 26	25.8	1.58	180	2610	200	2900	450	2850

*Available for quantity

E0.000.0918.15.00IM06



2.5MB

- Double shaft seal.
- Outrigger bearing available.
- Flanges: European, SAE A, SAE B, 3 Bolt.
- Ports: European and American standards.
- Shafts: European and American standards.



TYPE	Displacement		Max. continuous pressure P ¹		Max. starting pressure P ²		Min. speed at P ¹	Max. speed at P ²
	cm ³ /rev	cu.in/rev	bar	psi	bar	psi	min ⁻¹	
2.5MB - 16	16	0.97	250	3625	280	4060	600	3000
2.5MB - 19	19.3	1.17	250	3625	280	4060	600	3000
2.5MB - 22	22.2	1.35	250	3625	280	4060	500	3000
2.5MB - 25	25.2	1.53	250	3625	280	4060	500	3000
2.5MB - 28	27.6	1.68	250	3625	280	4060	500	3000
2.5MB - 32	32.4	1.97	230	3330	250	3625	500	3000
2.5MB - 38	38.1	2.32	200	2900	220	3140	400	2750
2.5MB - 44	44.2	2.69	170	2465	190	2755	400	2500

3ME

- Double shaft seal.
- Outrigger bearing available.
- Flanges: European, German standards and SAE B.
- Ports: European, German and American standards.
- Shafts: European and American standards.



TYPE	Displacement		Max. continuous pressure P ¹		Max. starting pressure P ²		Min. speed at P ¹	Max. speed at P ²
	cm ³ /rev	cu.in/rev	bar	psi	bar	psi	min ⁻¹	
3ME - 27	27	1.65	250	3625	300	4350	600	3000
3ME - 33	33.5	2.04	250	3625	300	4350	600	3000
3ME - 38	38.7	2.36	250	3625	300	4350	500	2750
3ME - 46	46.9	2.86	250	3625	280	4060	500	2750
3ME - 55	54.1	3.3	220	3140	250	3625	400	2500
3ME - 65	63.1	3.85	200	2900	240	3480	400	2500
3ME - 75	73.4	4.48	180	2610	220	3140	400	2500



2ME CONFIGURATIONS



Reversible

- available also with internal drain



Air compressor drive

- electric or manual motor speed control
- electric venting valve



Fan drive

- Compact design.
- High pressure level thanks to a cast iron manifold.
- Proportional relief valve for a precise temperature regulation.
- Available with directional valve for an efficient declogging of the fan.
- Waterproof coils protection up to IP69K.
- Reduced weight thanks to a Finite Elements structural optimization.
- Protection against pressure and torque shocks.
- Maximum speed in case of electric power failure.

EO.000.0918.15.00IM06



GENERAL CONSTRUCTIVE FEATURES

- Gear pumps made with Cast iron body, flanges, rear bodies and cover.

GENERAL FUNCTIONAL FEATURES

- High pressure capability by DU bearing.
- 12 teeth integral one piece gear and shaft.
- Double shaft seals.

Note: For bidirectional pump the max pressure has to be reduced by 10%. The max pressure is referred to pumps with flanged ports, using the threaded ports the pump life could be reduced.



2PGE

- High volumetric efficiency by innovative design and accurate control of machining tolerances.
- Flanges: European, German, SAE A, SAE B, ISO (for PTO designs).
- Ports: European, German and American standards.
- Shaft: European and American standards.

** Max speed allowed with P² pressure working continuously at P¹ the max. speed must be reduced by 10%.

TYPE	Displacement		Continuous pressure P ¹		Intermittent pressure P ²		Peak pressure P ³		Min. speed at P ¹	Max. speed at P ² **
	cm ³ /rev	cu.in/rev	bar	psi	bar	psi	bar	psi		
2PGE - 6.5	6.5	0.4	270	3915	300	4350	320	4650	600	4000
2PGE - 8.3	8.2	0.5	270	3915	300	4350	320	4650	500	3500
2PGE - 11.3	11.5	0.68	270	3915	300	4350	320	4650	500	3500
2PGE - 13.8	13.8	0.84	270	3915	300	4350	320	4650	500	3500
2PGE - 16	16.6	1.01	270	3915	300	4350	320	4650	500	3000
2PGE - 19	19.4	1.18	270	3915	300	4350	320	4650	500	3000
2PGE - 22.5	22.9	1.37	250	3625	280	4060	300	4350	500	2750
2PGE - 26	25.8	1.58	230	3335	260	3750	280	4060	500	2500

PG330 - OEMS Construction

PG331 - Dealers Construction

- High volumetric efficiency throughout the full pressure range, by narrow machining tolerance range and by floating thrust plates, that ensure axial compensation too.
- Flanges: European, SAE A, SAE B, SAE C, ISO (for PTO designs).
- Ports: European and American standards.
- Shafts: European and American standards.



** Max speed allowed with P² pressure working continuously at P¹ the max. speed must be reduced by 10%.

TYPE	Displacement		Continuous pressure P ¹		Intermittent pressure P ²		Peak pressure P ³		Min. speed at P ¹	Max. speed at P ² **
	cm ³ /rev	cu.in/rev	bar	psi	bar	psi	bar	psi		
PG330 - 23	23.4	1.43	260	3750	280	4060	300	4350	400	3000
PG330 - 28	28.6	1.74	280	4060	300	4350	320	4650	400	3000
PG330 - 34	34.4	2.1	280	4060	300	4350	320	4650	400	3000
PG330 - 40	40.3	2.46	260	3750	280	4060	300	4350	400	2700
PG330 - 47	47.4	2.89	280	4060	300	4350	320	4650	400	2700
PG330 - 55	55.2	3.37	260	3750	280	4060	300	4350	400	2700
PG330 - 64	64.3	3.92	240	3500	260	3750	280	4060	350	2500
PG330 - 72	73.4	4.48	220	3200	240	3500	260	3750	350	2500
PG330 - 80	80.6	4.91	200	2900	220	3200	240	3500	350	2500

E0.000.0918.15.001M06



PG330 and PG331

Sharing the same features, in terms of dimensions and working conditions.

PG330 optimized for high volume and for OEM's customers, PG331 has been designed for Retailers simplifying the switch from single to multiple stage pump configuration. Both are available in single, double, triple version.

PG330 Single pump

PG330 Multiple pump assembly

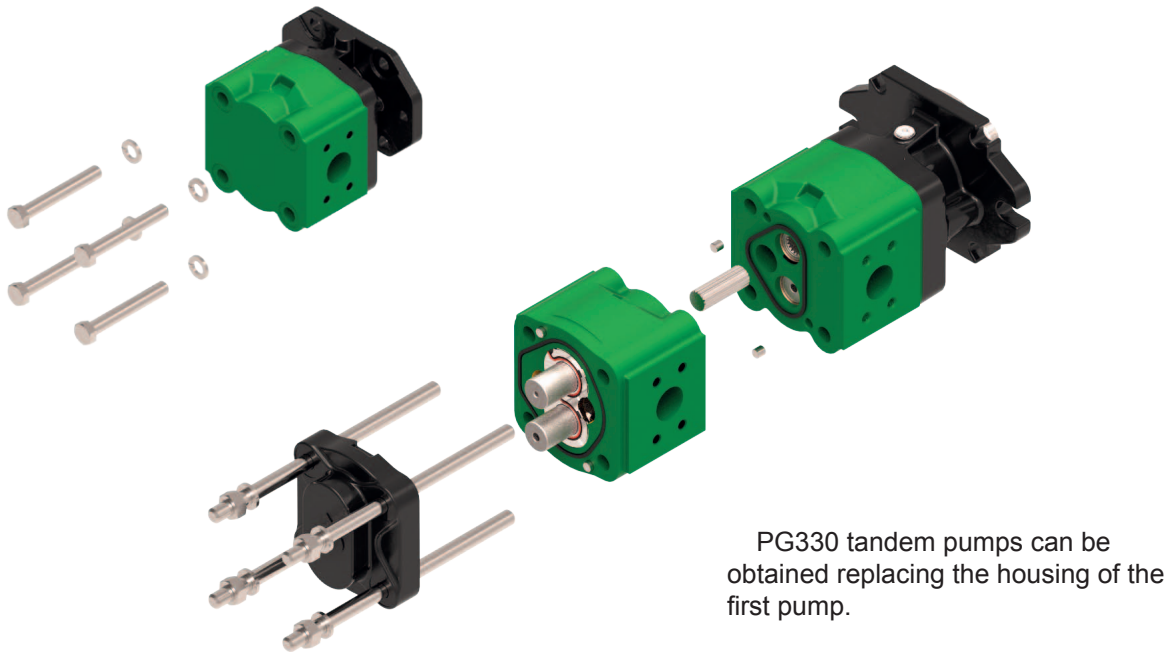

PG330 tandem pumps can be obtained replacing the housing of the first pump.

PG331 Single pump

PG331 Multiple pump assembly

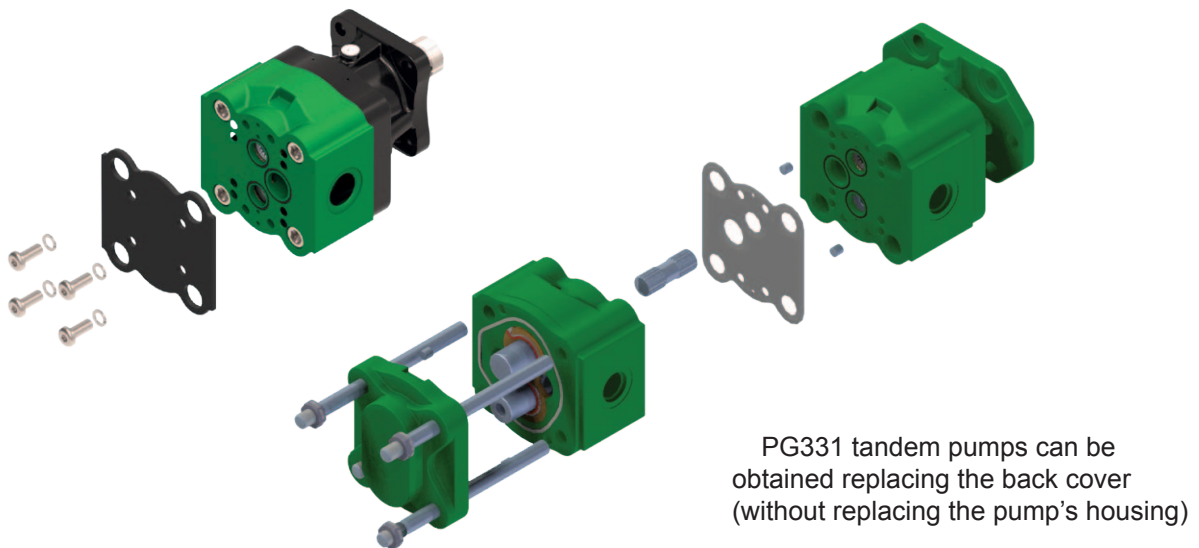

PG331 tandem pumps can be obtained replacing the back cover (without replacing the pump's housing)

EO.000.0918.15.00IM06



MULTIPLE STAGE CONFIGURATIONS WITH DIFFERENT PUMPS GROUP



2PGE/1.5PE

Allowed combination:

one or a multiple 2PGE pump assembled with one or a multiple 1.5PE pump, with common or separated suction.



2PGE/2PE

Allowed combination:

one or a multiple 2PGE pump assembled with one or a multiple 2PE pump, with common or separated suction.



PG330/2PGE PG330/2PE

Allowed combination:

one or a multiple PG330 pump assembled with one or a multiple 2PE or 2PGE pump, with common or separated suction.



PG331/2PE PG331/2PGE

Allowed combination:

one or a multiple PG331 pump assembled with one or a multiple 2PE or 2PGE pump, with common or separated suction.



GENERAL CONSTRUCTIVE FEATURES

- Gear motors made with Cast iron body, flanges, rear bodies and cover.

GENERAL FUNCTIONAL FEATURES

- High pressure capability by DU bearings.
- 12 teeth integral one piece gear and shaft.
- Double shaft seal.

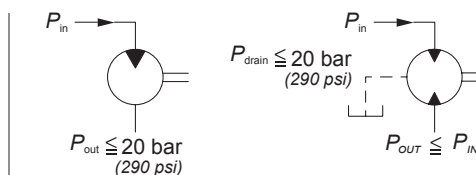

The Motors are equipped with HPD shaft seal (20bar), on request is available also for motor with outrigger bearing. Max drain pressure is influenced by rotational speed of the unit.

2MGE

- High volumetric efficiency by innovative design and accurate control of machining tolerances.
- Flanges: European, German, SAE A, SAE B.
- Ports: European, German and American standards.
- Shaft: European and American standards.



TYPE	Displacement		Max. continuous pressure P ¹		Max. starting pressure P ²		Min. speed at P ¹	Max. speed at P ²
	cm ³ /rev	cu.in/rev	bar	psi	bar	psi		
2MGE - 6.5	6.5	0.4	250	3625	280	4060	600	4000
2MGE - 8.3	8.2	0.5	250	3625	280	4060	600	3600
2MGE - 11.3	11.5	0.68	250	3625	280	4060	600	3500
2MGE - 13.8	13.8	0.84	250	3625	280	4060	600	3400
2MGE - 16	16.6	1.01	250	3625	280	4060	450	3200
2MGE - 19	19.4	1.18	220	3190	240	3480	450	3200
2MGE - 22.5	22.9	1.37	200	2900	220	3190	450	3000
2MGE - 26	25.8	1.58	180	2610	200	2900	450	2850

MG330

- High volumetric efficiency throughout the full pressure range, by narrow machining tolerance range and by floating thrust plates, that ensure axial compensation too.
- Flanges: European, SAE B, SAE C.
- Ports: European and American standards.
- Shaft: European and American standards.



TYPE	Displacement		Max. continuous pressure P ¹		Max. starting pressure P ²		Min. speed at P ¹	Max. speed at P ²
	cm ³ /rev	cu.in/rev	bar	psi	bar	psi		
MG330 - 34	34.4	2.1	240	3480	300	4350	600	3000
MG330 - 40	40.3	2.46	220	3190	280	4060	550	2700
MG330 - 47	47.4	2.89	240	3480	280	4060	550	2700
MG330 - 55	55.2	3.37	220	3190	280	4060	550	2700
MG330 - 64	64.3	3.92	200	2900	260	3750	500	2500
MG330 - 72	73.4	4.48	200	2900	260	3750	500	2500



GENERAL CONSTRUCTIVE FEATURES

- Gear flow dividers made with aluminium body, cast iron side covers.

GENERAL FUNCTIONAL FEATURES

- High volumetric efficiency achieved by floating bushings and axial compensation.
- Two or more modular stages.
- 12 teeth integral one piece gear and shaft in every single stages.
- Available with ports for the main European, German and American standards.
- Common Inlet Port available also on the side-cover.



1.5DRE

- Common Inlet Port available also on the side-cover.
- Assembling up to 8 Stages possible.
- 1.5DRE-VA: cylinder synchronize function.

TYPE	Displacement		Max outlet pressure				Max outlet Δp		Speed		Flow per section		Flow per section	
			P ₁	P ₂	P ₁	P ₂	between sections		min.	max.	min.	max.	min.	max.
	cm ³ /rev	cu.in./rev	bar	bar	psi	psi	bar	psi	min-1		l/min		gpm	
1.5DRE - 2.8	2.8	0.17	250	270	3625	3915	50	725	1200	4500	3.54	13.26	0.93	3.49
1.5DRE - 3.5	3.5	0.21	250	270	3625	3915	50	725	1200	4500	4.42	16.58	1.16	4.36
1.5DRE - 4.1	4.1	0.25	250	270	3625	3915	50	725	1200	4000	5.18	17.26	1.36	4.54
1.5DRE - 5.2	5.2	0.32	230	250	3335	3625	50	725	1200	4000	6.57	21.89	1.73	5.76
1.5DRE - 6.2	6.2	0.38	230	250	3335	3625	50	725	1200	3400	7.83	22.19	2.06	5.84
1.5DRE - 7.6	7.6	0.46	200	220	2900	3190	50	725	1200	3400	9.60	27.20	2.53	7.16
1.5DRE - 9.3	9.3	0.57	180	200	2610	2900	50	725	1200	3000	11.75	29.37	3.09	7.73
1.5DRE - 11	11	0.67	170	190	2465	2755	50	725	1200	3000	13.89	34.74	3.66	9.14

2DRE

- All bodies pre-arranged for assembling of AR cylinder synchronize valves.
- Assembling up to 8 Stages possible.
- 2DRE-VA: cylinder synchronize function.
- 2DRE-AR: for cylinder synchronized in both directions (additional Tank connection required)

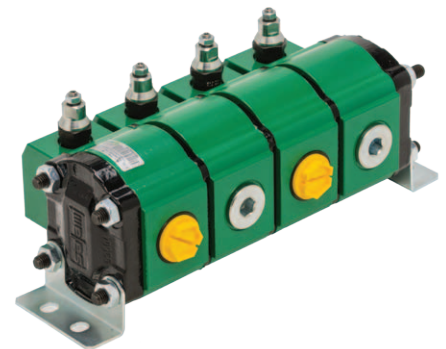

TYPE	Displacement		Max. Outlet Pressure				Max. Outlet Δp		Speed		Flow per section		Flow per section	
			P ₁	P ₂	P ₁	P ₂	between sections		min.	max.	min.	max.	min.	max.
	cm ³ /rev	cu.in./rev	bar	bar	psi	psi	bar	psi	min ⁻¹		l/min		gpm	
2DRE - 8,3	8.20	0.50	250	280	3625	4060	50	725	1200	3600	10.36	31.07	2.73	8.18
2DRE - 10,5	10.60	0.65	250	280	3625	4060	50	725	1200	3500	13.39	39.05	3.52	10.28
2DRE - 11,3	11.50	0.68	250	280	3625	4060	50	725	1200	3500	14.53	42.37	3.82	11.15
2DRE - 12,5	12.70	0.77	250	280	3625	4060	50	725	1200	3400	16.04	45.45	4.22	11.96
2DRE - 13,8	13.80	0.84	250	280	3625	4060	50	725	1200	3400	17.43	49.39	4.59	13.00
2DRE - 16	16.60	1.01	250	280	3625	4060	50	725	1100	3200	19.22	55.92	5.06	14.71
2DRE - 19	19.40	1.15	220	240	3150	3450	50	725	1100	3200	22.46	65.35	5.91	17.20
2DRE - 22,5	22.90	1.37	220	240	3150	3450	50	725	1100	3000	26.52	72.32	6.98	19.03
2DRE - 26	25.80	1.58	200	220	2900	3150	50	725	1100	2850	29.87	77.40	7.86	20.37
2DRE - 30	30.10	1.84	200	220	2900	3150	50	725	1100	2700	34.85	85.55	9.71	22.51

E0.000.0918.15.001M06



2PE - High Low Multiple Pump- VSQ

High-Low option is the most suitable choice when the actuator needs quick movements without pressure and slow speed under load. This particular dual pump with integrated valves has been specially designed for applications such as clamping mechanisms, metal forming, crimping machines, compactors, splitters, etc.

- For this Unloading valve you can choose two setting ranges:
30-60 bar (440-870 psi)
60-120 bar (870-1740 psi)



Example: 6.5cc/16cc - 1500 rpm - 50 bar

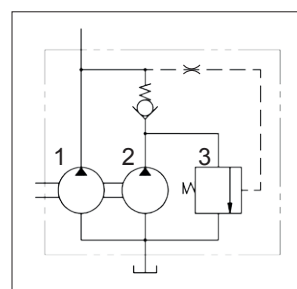
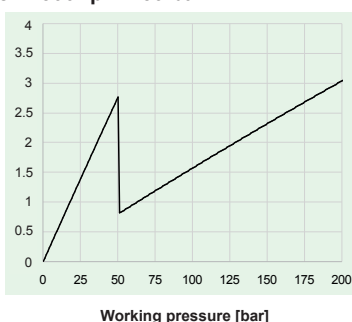
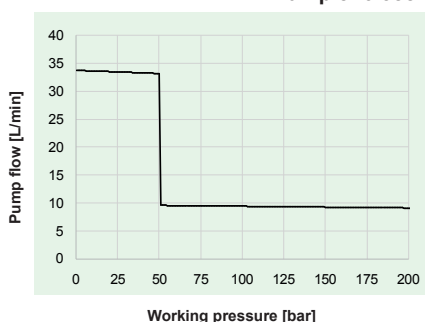

1= Stage high pressure
2= Stage low pressure
3= Unloading valve

Priority flow valve - VPS1/VPDS1

Two different type of valve available:

- fixed priority flow valve
- Dynamic priority flow valve adjustable by LS signal.



VPS1

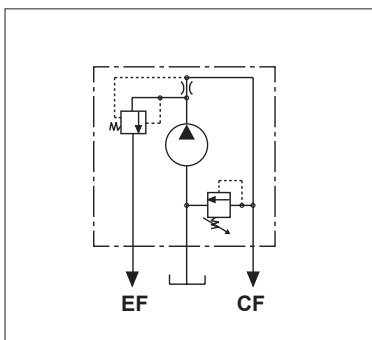

CF= Priority flow port
EF= Excess flow port

VPDS1

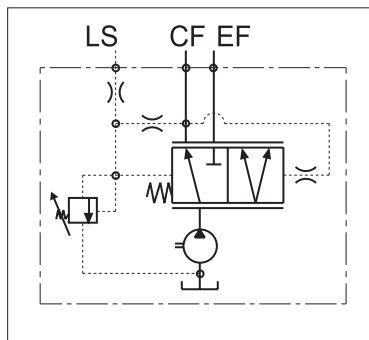

CF= Priority flow port
EF= Excess flow port
LS= Load sensing signal port

E0.000.0918.15.00IM06

