



OIL SOLUTIONS

BUCHER
hydraulics

PO Box 38
Strathfieldsaye, VIC, 3551
1800 OIL SOL
1800 645 765
sales@oilsolutions.com.au

www.oilsolutions.com.au

"For All Your Hydraulic Needs"

Internal Gear Pumps

New Generation QXEHX

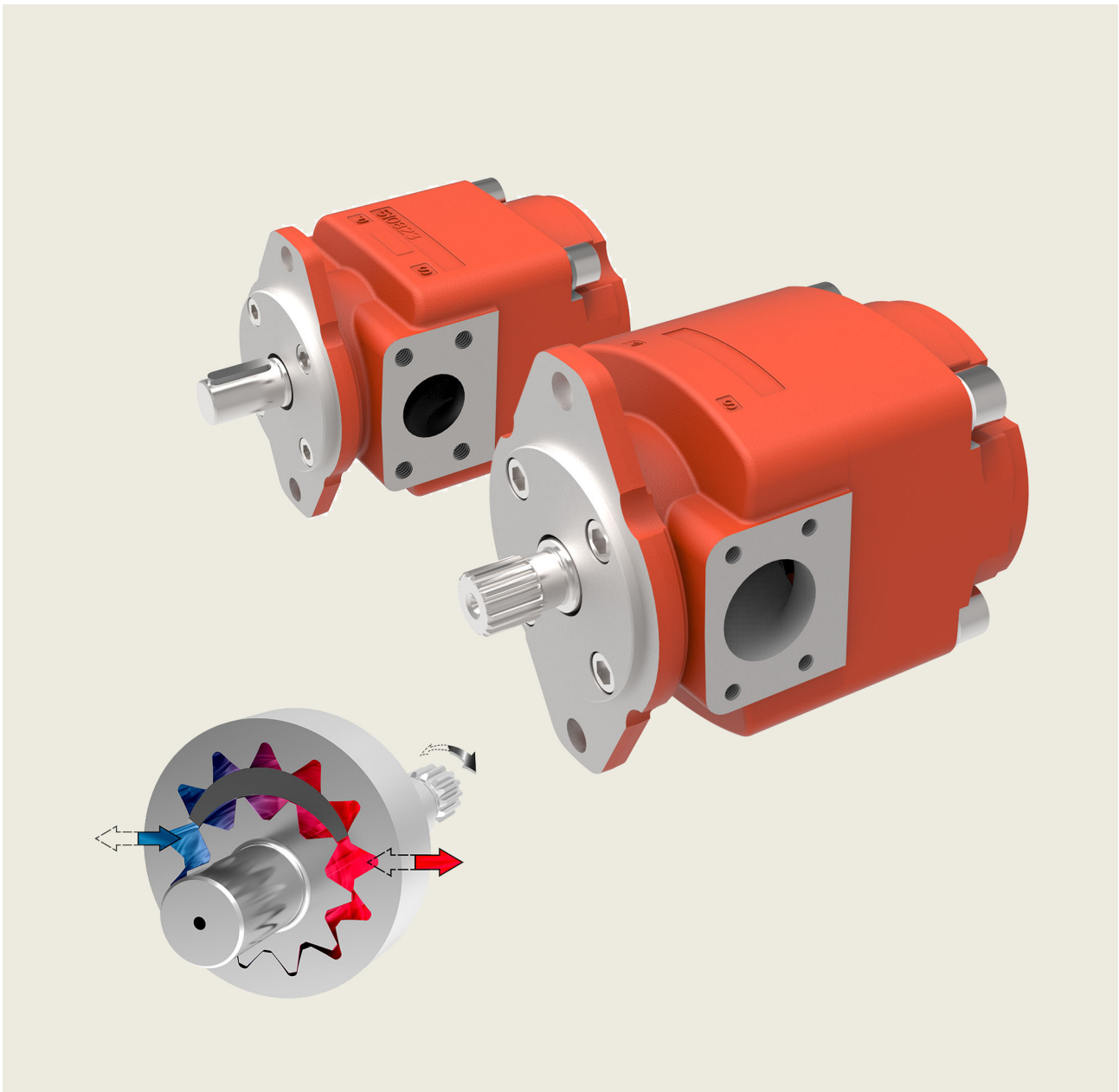

Reference: 100-P-000227-EN-02

Contents		Page
1	General	5
	1.1 Product description	5
	1.2 Advantages	5
	1.3 Application examples	5
2	Technical data	5
	2.1 General	5
	2.2 Main characteristics	6
3	Characteristic curves	7
	3.1 Efficiencies $[\eta]$	7
	3.2 Noise level (Lp)	8
	3.3 Operation with variable-speed drives	9
4	Dimensions	10
	4.1 Dimensions size 3	10
	4.2 Dimensions size 4 - 6	11
5	Ordering code	11
	5.1 Ordering example:	11
	5.2 Standard configuration	11
	5.3 Options	11
6	Fluid	12
7	Operational reliability	12
8	Note	12
9	Accessories	13
	9.1 Pipe flanges - high pressure type	13
	9.2 Pipe flanges - low pressure type (welding flange)	13
	9.3 Bolt-on valves - SAE J518 code 61 / ISO 6162-1 pattern	14

1 General

1.1 Product description

The newly developed QXEHX pump series is the successor to the QXEH and offers several new advantages.

In addition to the proven reliability and very low noise level of all Bucher Hydraulics internal gear units, the new QXEHX series has been specially developed for very high speeds. The maximum speeds have been increased by around 20%. The hydrodynamic lubrication has been improved still more, increasing the operational reliability of the pump many times over. Overlapping displacements now offer a greater choice, so you can always find the optimum pump size for every application. Bucher Hydraulics has also succeeded in making the new QXEHX even quieter.

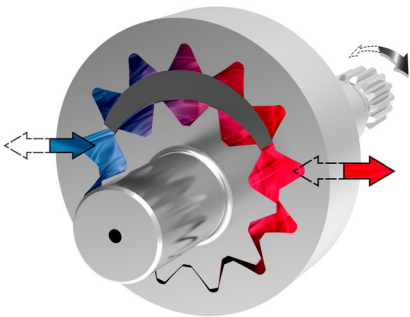

1.2 Advantages

- Speeds up to 4600 rpm
- Maximum reliability, even in reversing operation
- Very long service life even with cyclic loading
- Cavitation-resistant with critical fluids
- Very low noise levels
- Ideally suited for use with variable-speed drives
- Heavy-duty materials; can thus be used in difficult environments and with various fluid

1.3 Application examples

- Injection moulding machines
- Plastics-processing machines
- Die casting machines
- Hydraulic forming presses
- Hydraulic power units
- Machine tools
- Waste compactors
- Wind turbines
- Lift/elevator drives

2 Technical data

2.1 General

For other values, please contact Bucher Hydraulics

General characteristics	Unit	Description, Value
Installation attitude		unrestricted
Mounting method (standard)		oval 2-hole flange to ISO 3019/1 (SAE)
Direction of rotation		CW (clockwise)
Reverse mode		for pressure control / pressure relief (for the application limits, please contact Bucher Hydraulic)
Pump drive method		in-line, through a flexible coupling, or direct connection via SAE splines
Fluids		HLP mineral oils to DIN 51524 Part 2 HFC fluids to VDMA 24317
Maximum permissible degree of contamination of the hydraulic fluid		ISO 4406 code 20/18/15
Viscosity range	mm ² /s	Operating viscosity 10 ... 100 / starting viscosity 10 ... 300
Fluid temperature range (note viscosity limits)	°C	HLP-mineral oils -20 ... +80 / Option 09: -20... +100 HFC fluids -20 ... +50 Range for max. service life +30 ... +60
Inlet pressure at suction port	bar	maximum 100 absolute / minimum 0.5 ... 0.98 absolute (dependent on displacement and speed)
Pressure at the drain port	bar	max. 1.5 absolute
Seal material		NBR = standard / FPM (Viton) = option

2.2 Main characteristics

IMPORTANT: The main characteristics are valid for hydraulic oils to DIN 51524 with a viscosity of 20 ... 50 mm²/s and HFC fire-resistant fluids to VDMA 24317.

Displacement	Flow rate at speed	Maximum speed		Code	Operating pressure at P				Power consumption
		Mineral oil	HFC		continuous [bar]		intermittent [bar] ²⁾		
[cm ³ /rev] ¹⁾	[l/min]	[rpm] ³⁾	[rpm] ³⁾		Mineral oil	HFC	Mineral oil	HFC	[kW] ⁴⁾
10,0	14,5	6050	5500	QXEHX32-010	250	220	280	240	6,0
12,6	18,3	5600	5000	QXEHX32-012	250	220	280	240	7,6
15,6	22,6	4850	4300	QXEHX32-016	250	220	280	240	9,4
20,0	29,0	4500	3950	QXEHX32-020	210	180	250	200	10,2
20,3	29,5	4600	4300	QXEHX42-020	250	220	280	240	12,3
25,1	36,4	4250	3950	QXEHX42-025	250	220	280	240	15,2
32,3	46,8	3900	3550	QXEHX42-032	250	220	280	240	19,5
40,6	58,8	3500	3050	QXEHX42-040	210	180	250	200	20,6
39,1	56,9	3600	3200	QXEHX52-040	250	220	280	240	23,6
50,3	73,2	3400	3000	QXEHX52-050	250	220	280	240	30,4
63,4	92,1	3250	2800	QXEHX52-063	250	220	280	240	38,3
78,3	113,5	2950	2450	QXEHX52-080	210	180	250	200	39,7
79,8	115,7	3000	2800	QXEHX62-080	250	220	280	240	48,2
100,5	145,7	2800	2600	QXEHX62-100	250	220	280	240	60,7
124,2	180,1	2600	2400	QXEHX62-125	250	220	280	240	75,0
159,7	231,6	2400	2100	QXEHX62-160	210	180	250	200	81,0

1) Due to manufacturing tolerances, there may be slight variations in the displacement.

2) Max. 20 second per minute, and not more than 40% of the duty cycle.

3) Value for inlet pressure of min. 0.95 bar absolute and outlet pressure > 100 bar

4) Theoretical value (without considering efficiencies) at the maximum permitted continuous pressure for mineral oil at n = 1450 rpm

3 Characteristic curves

IMPORTANT. The performance graphs shown are valid for the specified pump models and parameters. For other pump sizes and operating conditions, contact Bucher Hydraulics.

3.1 Efficiencies [η]

IMPORTANT. measured at viscosity 42 mm²/s and speed n = 1450 rpm.

3.1.1 QXEHX32

Volumetric efficiency

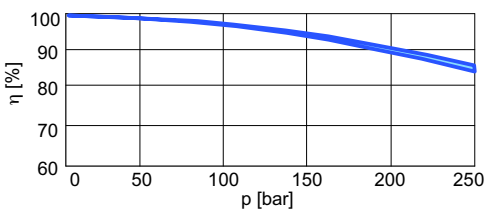

Hydromechanical efficiency

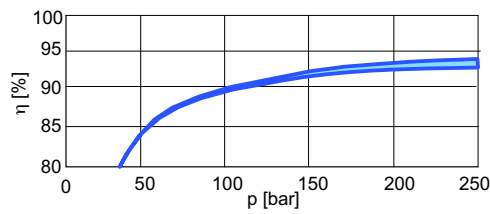

3.1.2 QXEHX42

Volumetric efficiency

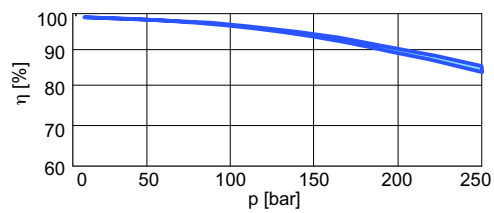

Hydromechanical efficiency

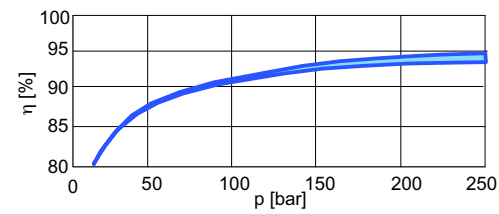

3.1.3 QXEHX52

Volumetric efficiency

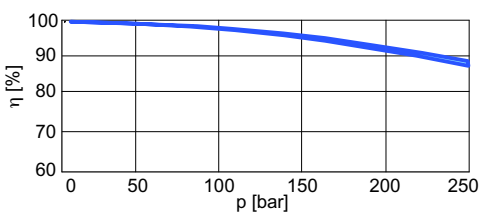

Hydromechanical efficiency

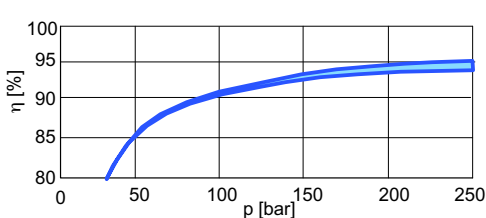

3.1.4 QXEHX62

Volumetric efficiency

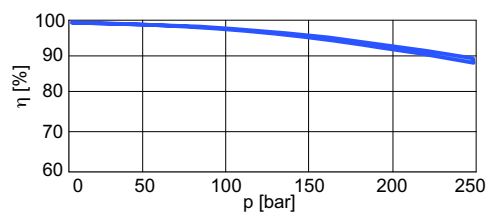

Hydromechanical efficiency

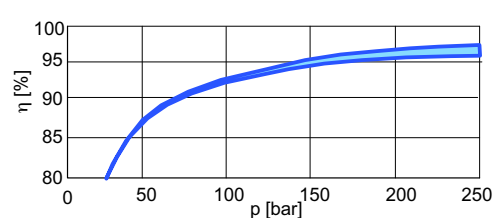

3.2 Noise level (L_p)

IMPORTANT. Measured to DIN 45635, Part 26, in an anechoic noise measurement chamber; with HLP46 and viscosity = 42 mm²/s (cSt). Values valid for single pumps with deviations of $\pm 1,5$ dB(A).

3.2.1 QXEHX32

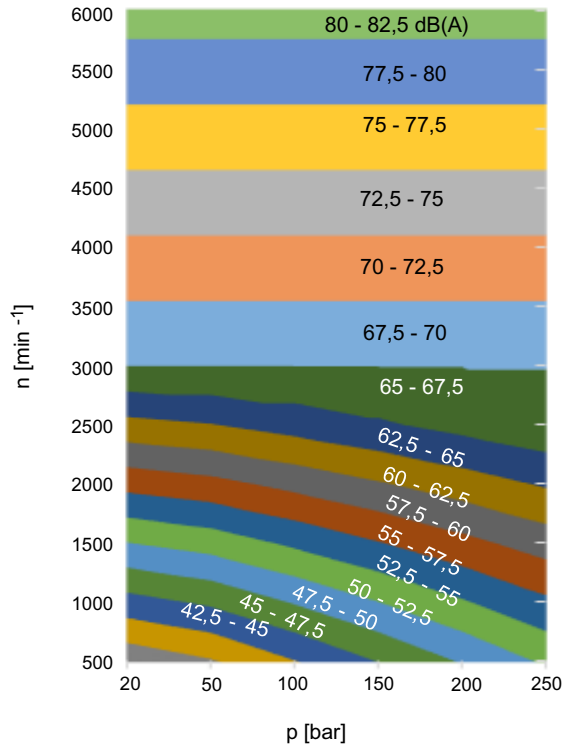

3.2.2 QXEHX42

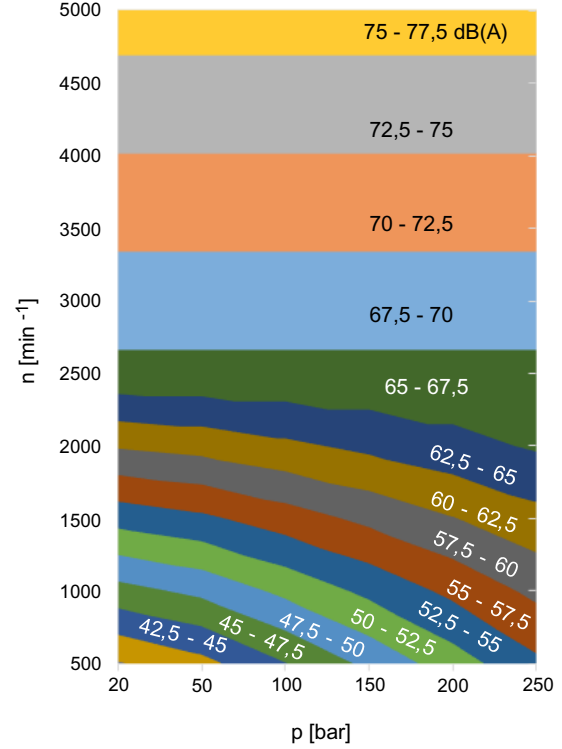

3.2.3 QXEHX52

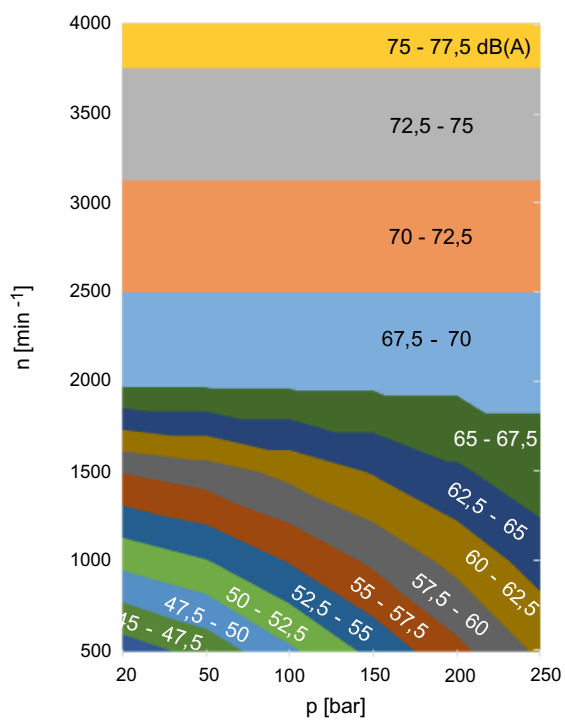

3.2.4 QXEHX62

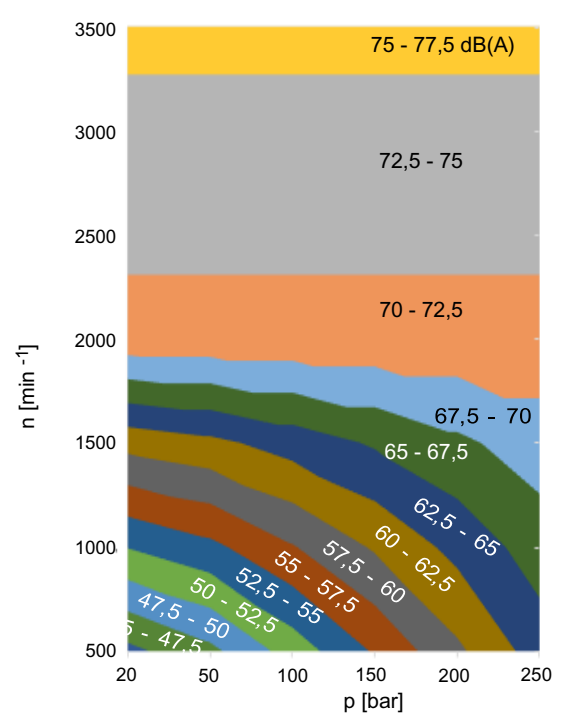

3.3 Operation with variable-speed drives

IMPORTANT: The following main characteristics are to be understood as examples only. They are valid only for the QXEHX52-063R with a viscosity of 42 mm²/s.
We would be very happy to advise you on the layout of your drive.

3.3.1 Typical load cycle for injection moulding machine

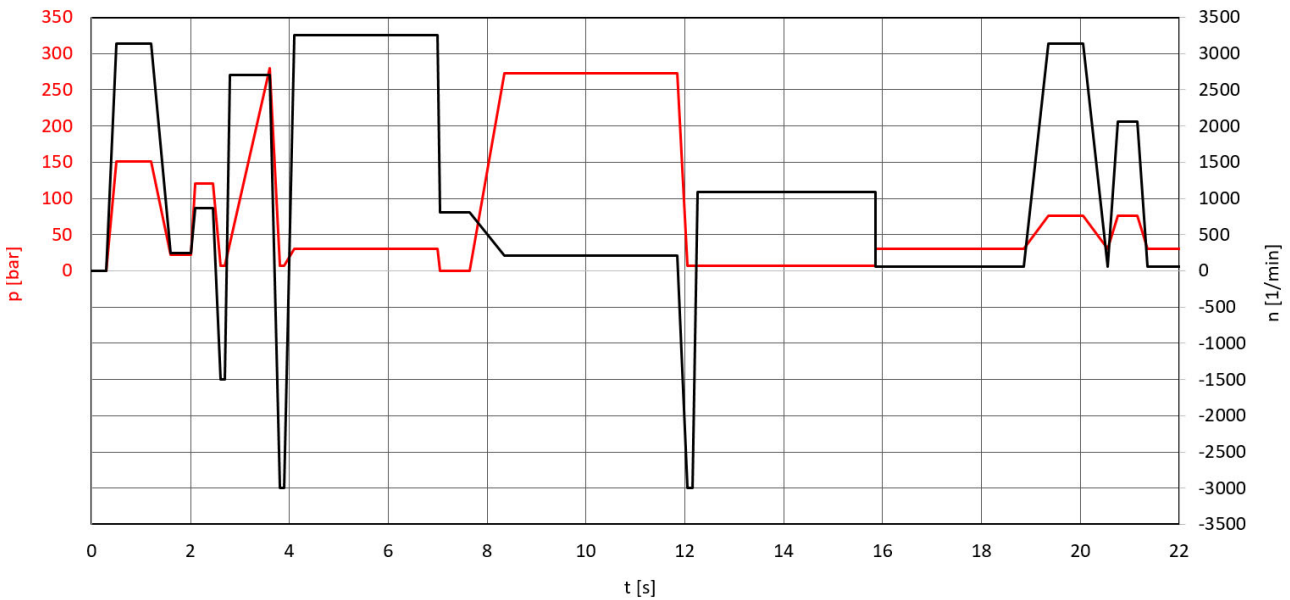

3.3.2 Minimum pressure (absolute) at pump inlet as a function of speed

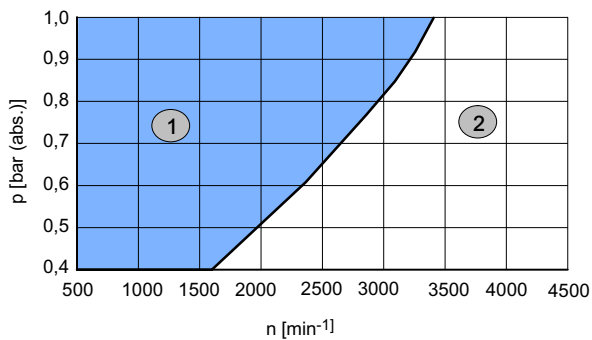

1	Continuous operation
2	No operation (risk of cavitation)

3.3.3 Minimum speed as a function of pressure at outlet port P

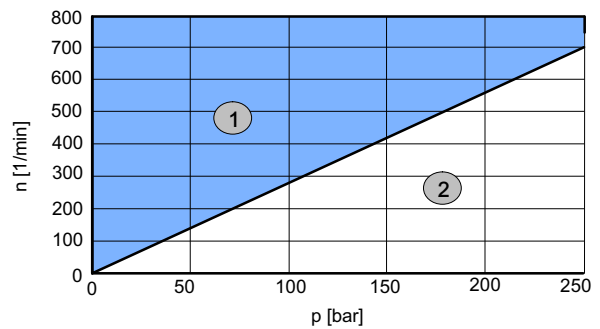

1	Continuous operation
2	Operation only with time limit. Clarify detailed application limits with Bucher Hydraulics

4 Dimensions

Frame size		QXEHX32	QXEHX42	QXEHX52	QXEHX62
Suction port	S	G1¼" 2) Gewinde	1½" 1)	2" 1)	2½" 1)
Pressure port	P	¾" 1)	1" 1)	1¼" 1)	1½" 1)
External drain port (option)	①	G¼"	G¼"	G¼"	G¾"
Mounting method: oval 2-hole flange to ISO 3019/1 (SAE)	A	132	170	212	267
	B (SAE)	106	146	181	229
	C	11	14	18	22
	N (SAE)	82,55 - 0,05	101,6 - 0,05	127 - 0,05	152,4 - 0,05
	O	8,5	10,5	12,5	16,5
	V	6	7	7	7
Shaft end: parallel, to ISO/R775 (other shaft ends on application)	D	20 j6	25 j6	32 j6	40 j6
	E	36	42	58	82
	F	6	8	10	12
	G	22,5	28	35	43
	I	44	51	68	92
Body	K	44	52,5	60,5	69
	L	148,5	181,5	210	264
	T1	107	133	177	220
	T2	103	120	152	190
	Z	60	62,5	79	99,5
Weight	kg	9,5	17	32	62,6

1) Pipe flange dimensions, SAE J518 code 61 bzw. ISO 6162-1
 - high-pressure type for up to 420 bar (see section 9.1)
 - low-pressure type for up to 16 bar (see section 9.2)

2) Threaded ports to DIN 3852, Part 2.

4.1 Dimensions size 3

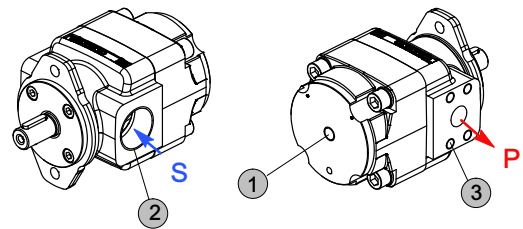
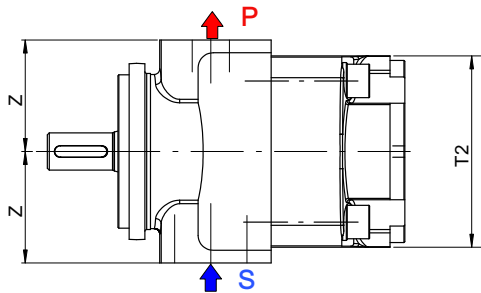
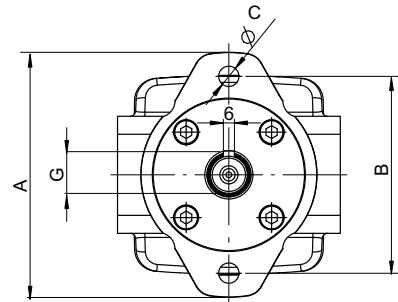
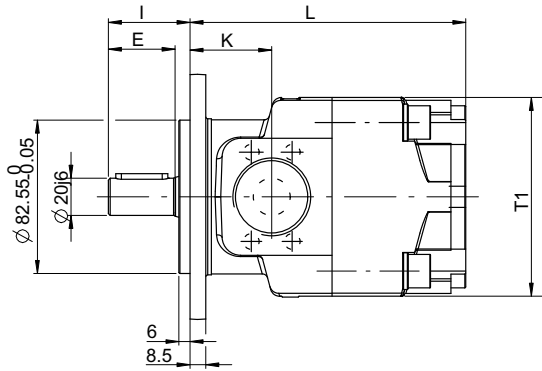

1	External drain port = standard	2	Threaded port to DIN 3852 Part 2
3	Pipe flange dimensions to SAE J518 code 61 or ISO 6162-1		

4.2 Dimensions size 4 - 6

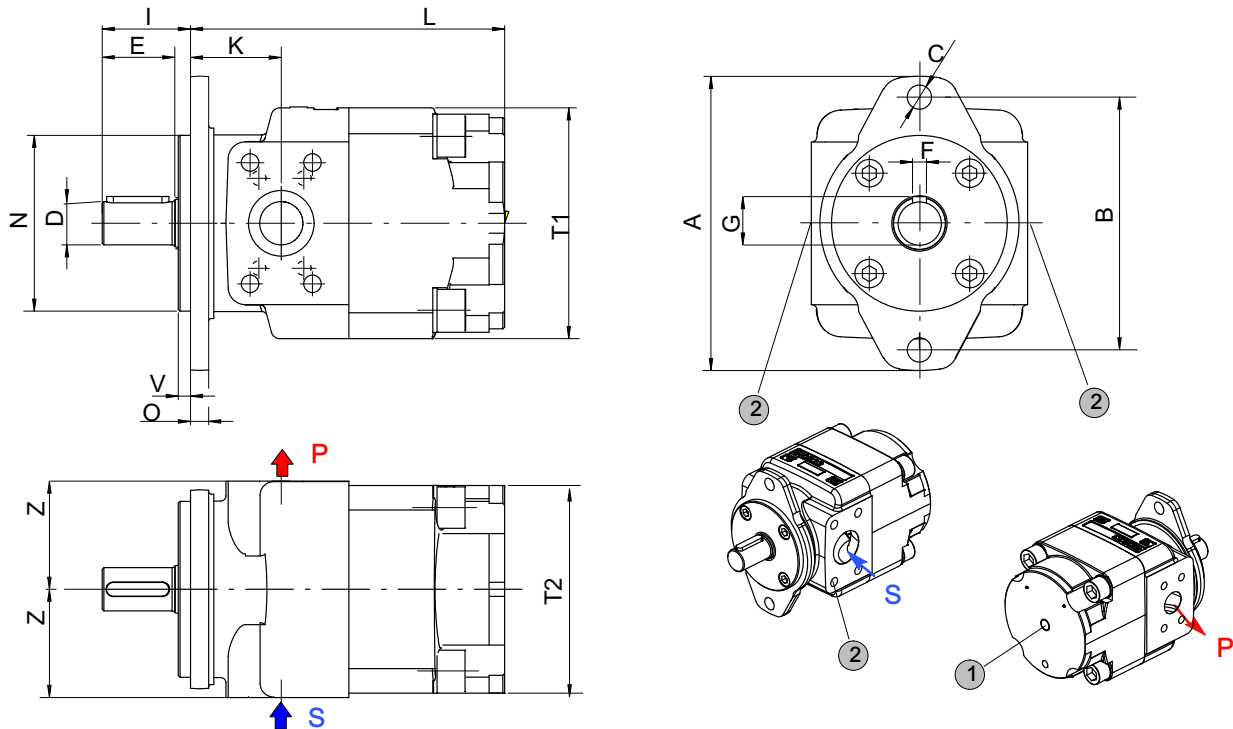

1	External drain port = standard	2	Pipe flange dimensions to SAE J518 code 61 or ISO 6162-1
---	--------------------------------	---	----------------------------------------------------------

5 Ordering code

Q X E H X | 5 2 | - 0 5 0 | R | 0 9

Series	=	QXEHX
Frame size	=	32, 42, 52, 62
Displacement cm ³ /rev	=	020 - 160
Direction of rotation (viewed from the shaft end) right / cw (standard)	=	R
Option:		see section 5.3

5.1 Ordering example:

Required:	single pump
Displacement	50 cm ³ /rev
Continuous pressure	250 bar
Seal material:	FPM (Viton)
For use with mineral oil	
Ordering Code:	QXEHX52-050R09

5.2 Standard configuration

- direction of rotation - right (cw)
- external drain port G1/4"
- 2-hole mounting flange to ISO 3019/1 (SAE)
- Nitrile seals (NBR)
- cylindrical shaft end to ISO R775
- black primer to RAL9004, flange without primer

5.3 Options

- O = pump without primer
- 09 = seal material FPM (Viton), pump without primer
- 11 = shaft end with spline shaft SAE ANSI B92.1, DIN ISO 3019-1

- 29 = pump without primer for HFC fluids

6 Fluid

QX pumps require fluid with a minimum cleanliness level of ISO 4406 code 20/18/15.

We recommend the use of fluids that contain anti-wear additives for mixed-friction operating conditions. Fluids without appropriate additives can reduce the service life of pumps and motors. The user is responsible for maintaining, and regularly checking, the fluid quality. Bucher Hydraulics recommends a load capacity of $\geq 30 \text{ N/mm}^2$ to Brügger DIN 51347-2. This is particularly important in applications with variable-speed drives and speeds $< 1000 \text{ rpm}$.

7 Operational reliability

To guarantee the reliable operation and long service life of the QXEHX internal gear pump, a maintenance schedule must be prepared for the power unit, machine or system. The maintenance schedule must make sure that the provided or permissible operating conditions of the pump are adhered to over the period of use.

In particular, compliance with the following operating parameters must be ensured:

- required oil cleanliness
- operating temperature range
- fluid level

Moreover, the pump and the system must be inspected at regular intervals for changes in the following parameters:

- Vibration
- Noise
- Differential temperature of pump – fluid in the tank
- Foaming in the tank
- Leak tightness

Changes in these parameters indicate wear of components (e.g. drive motor, coupling, pump, etc.). The cause must be immediately pinpointed and eliminated.

To provide high operational reliability of the QXEHX internal gear pump in the machine or system, we recommend continuous, automatic checks of the above parameters and an automatic shutdown in the case of changes that exceed the usual fluctuations within the provided operating range.

Make sure that the plastic components of the coupling are replaced regularly (no later than 5 years). The manufacturer's instructions must be given priority.

8 Note

This catalogue is intended for users with specialist knowledge. The user must check the suitability of the equipment described herein in order to ensure that all of the conditions necessary for the safety and proper functioning of the system are fulfilled. If you have any doubts or questions concerning the use of these pumps, please contact Bucher Hydraulics GmbH.

9 Accessories

9.1 Pipe flanges - high pressure type

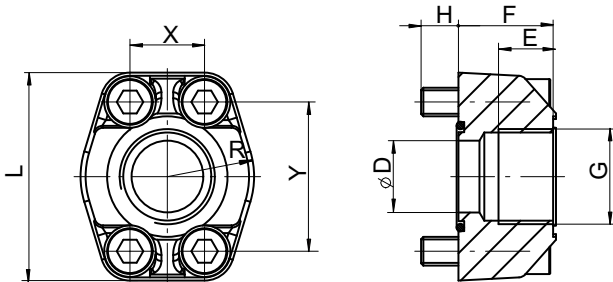

- Max. operating pressure 420 bar.
- Possible for frame size 4 - 6.
- Flange size SAE J518 code 61 / ISO 6162-1.
- Threaded pipe flanges are spot-faced for DIN 2353 pipe fittings.
- Material: ST37 / for FPM (Viton) seals, contact Bucher Hydraulics GmbH.

Ordering number	Ordering code	Size	D \varnothing	E	F	H	L	R	X	Y	O-ring 90 Shore A	Retaining screws DIN912-12.9 / [Nm]	
100037010	RF 02-R10	G $\frac{3}{4}$ "	20	18	30	12	65	26	22,2	47,6	26,65x2,62	M10x35	60
100037020	RF 03-R11	G1"	25	20	34	13	70	29	26,2	52,4	32,99x2,62	M10x35	60
100037030	RF 04-R12	G1 $\frac{1}{4}$ "	32	22	38	14	80	36	30,2	58,6	40,86x3,53	M10x40	60
100037040	RF 05-R13	G1 $\frac{1}{2}$ "	38	24	41	19	94	41	35,7	70	44,04x3,53	M12x45	120
100037050	RF 06-R14	G2"	50	26	45	20	102	48	42,9	77,8	59,92x3,53	M12x50	120

9.2 Pipe flanges - low pressure type (welding flange)

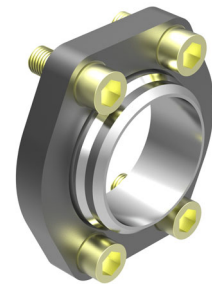
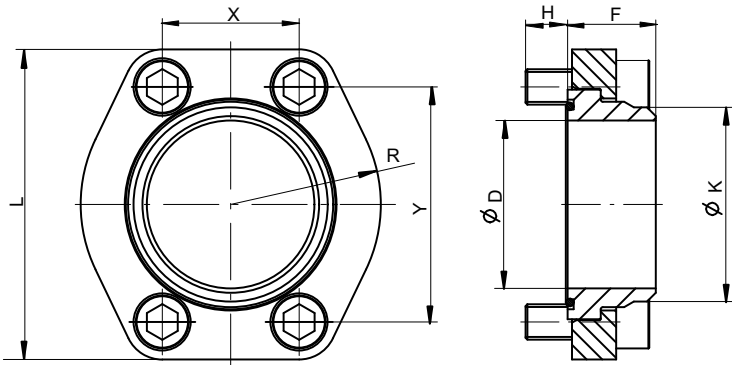

- Max. operating pressure 16 bar.
- Flange size SAE J518 code 61 / ISO 6162-1.
- Possible for frame size 6.

Material: HST37, for FPM (Viton) seals contact Bucher Hydraulics.

Ordering number	Ordering code	Size	D	K	F	H	L	R	X	Y	Viton seal 90 Shore 'A'	Retaining screws DIN 912-8.8 tightening torque Nm	pipe ¹⁾ outside diameter approx.
100062450	RN 07-S	2 $\frac{1}{2}$ "	63	75	35	14	120	57	51	89	69,44x3,53	M12 x 30 70	75

1) For connection pipes, we recommend the use of seamless precision steel tube to DIN 2391 with a wall thickness of 6 mm max.

9.3 Bolt-on valves - SAE J518 code 61 / ISO 6162-1 pattern

IMPORTANT: The following bolt-on valves are available for all QX internal gear units, sizes 3 and 4.
For future information about bolt-on valves contact www.bucherhydraulics.com

Pressure relief valve A $\frac{S}{G}$ DF	Pressure relief valve, solenoid control A $\frac{S}{G}$ DA	Accumulator charging valve AGSF
Technical data sheet 100-P-000123	Technical data sheet 100-P-000119	Technical data sheet 100-P-0000124

9.3.1 Examples of bolt-on valves, mounted on QX internal gear pumps

AGDF Bolt-on valve with threaded ports	ASDF+RF Bolt-on valve with SAE pipe flanges ¹⁾	Bolt-on valve with SAE pipe flanges + RVSAE ²⁾ ASDF+RF+RVSAE+DPSAE+ZPSAE
AGDF	ASDF+RF	

1) Pipe flange see section 9.1 and 9.2.

2) Please contact Bucher Hydraulics GmbH for suitable check valves.

info.kl@bucherhydraulics.com

www.bucherhydraulics.com

© 2020 by Bucher Hydraulics GmbH, D-79771 Klettgau

All rights reserved.

Data is provided for the purpose of product description only, and must not be construed as warranted characteristics in the legal sense. The information does not relieve users from the duty of conducting their own evaluations and tests. Because the products are subject to continual improvement, we reserve the right to amend the product specifications contained in this catalogue.

Classification: 410.100.000