

Sytronix SvP 7020 IMC

Speed Variable Pump Drives

Operating instructions
R911377189

Edition 01

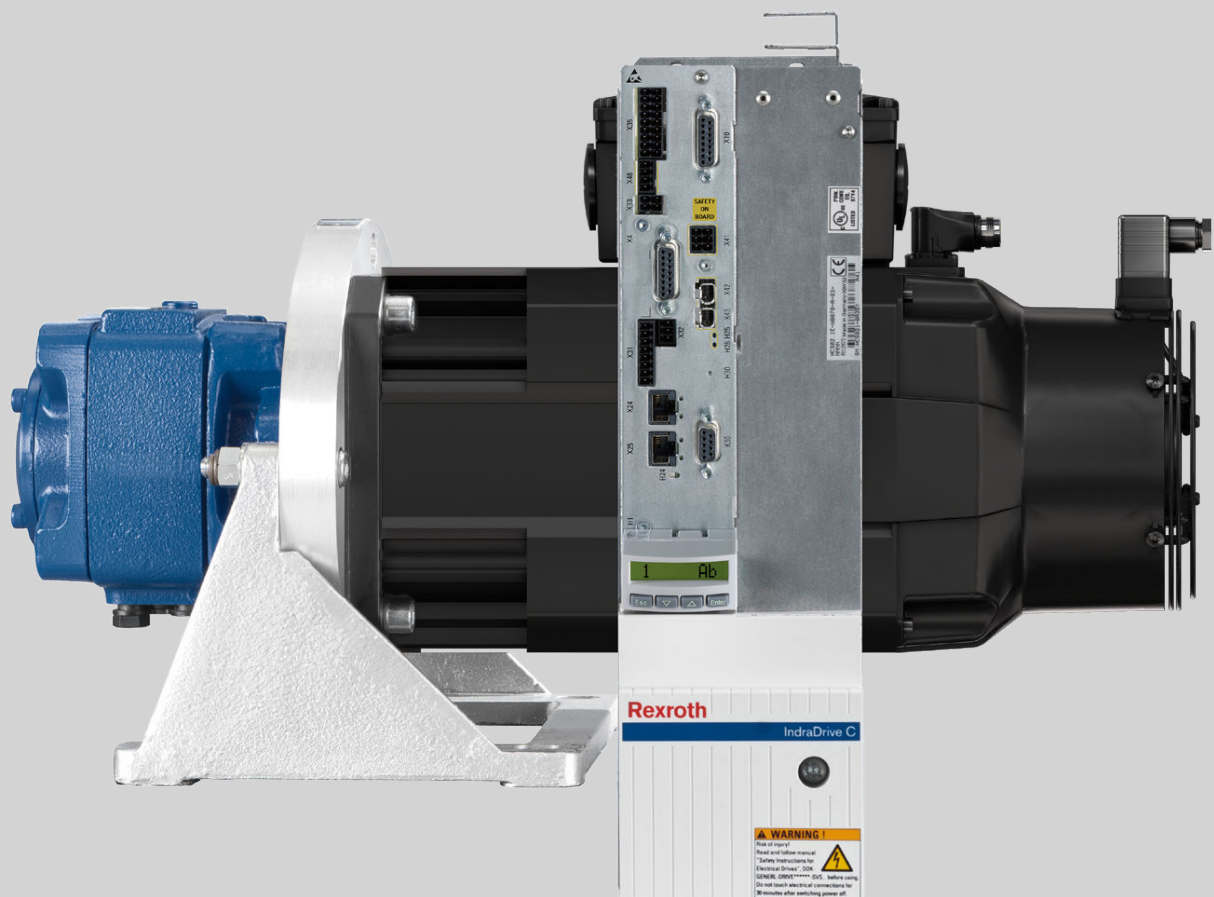

Title Sytronix SvP 7020 IMC
Speed Variable Pump Drives

Type of Documentation Operating instructions

Document Typecode DOK-SYTROX-SVP7020-I*C-IT01-EN-P

Internal File Reference RS-3a9682c782c713730a347ea5001830ab-1-en-US-7

Record of Revision

Edition	Release Date	Notes
01	2016-11	First edition

Copyright © Bosch Rexroth AG 2016

This document, as well as the data, specifications and other information set forth in it, are the exclusive property of Bosch Rexroth AG. It may not be reproduced or given to third parties without its consent.

Liability The specified data is intended for product description purposes only and shall not be deemed to be a guaranteed characteristic unless expressly stipulated in the contract. All rights are reserved with respect to the content of this documentation and the availability of the product.

Published by Bosch Rexroth AG
Bgm.-Dr.-Nebel-Str. 2 ■ 97816 Lohr a. Main, Germany
Phone +49 9352 18 0 ■ Fax +49 9352 18 8400
<http://www.boschrexroth.com/>

Table of Contents

	Page
1 About this documentation.....	5
1.1 Validity of this documentation.....	5
1.2 Amending documentations.....	5
1.2.1 Sytronix SvP 7020.....	5
1.2.2 Motor-pump unit.....	5
1.2.3 Pressure transducer.....	6
1.2.4 Drive controllers.....	6
1.2.5 Firmware.....	6
2 Important directions for use.....	9
2.1 Appropriate use.....	9
2.1.1 Introduction.....	9
2.1.2 Areas of use and application.....	9
2.2 Inappropriate use.....	10
3 Safety instructions for electric drives and controls.....	11
3.1 Definitions of terms.....	11
3.2 General information.....	12
3.2.1 Using the Safety instructions and passing them on to others.....	12
3.2.2 Requirements for safe use.....	12
3.2.3 Hazards by improper use.....	13
3.3 Instructions with regard to specific dangers.....	14
3.3.1 Protection against contact with electrical parts and housings.....	14
3.3.2 Protective extra-low voltage as protection against electric shock	15
3.3.3 Protection against dangerous movements.....	16
3.3.4 Protection against electromagnetic and magnetic fields during operation and mounting.....	17
3.3.5 Protection against contact with hot parts.....	17
3.3.6 Protection during handling and mounting.....	18
3.3.7 Battery safety.....	18
3.3.8 Protection against pressurized systems.....	19
3.4 Explanation of signal words and the Safety alert symbol.....	20
4 Speed variable Sytronix pump drives.....	21
4.1 Overview.....	21
4.2 Sytronix SvP 7020.....	22
4.2.1 Overview of components.....	22
4.2.2 System function.....	22
4.2.3 IMC device configuration.....	23
4.2.4 Documentation.....	24
5 Transport and storage.....	25
5.1 Drive controllers.....	25
5.2 Motor-pump unit.....	25

Table of Contents

	Page
6 Assembly.....	27
6.1 Drive controllers.....	27
6.2 Motor-pump unit.....	27
6.3 Pressure transducer HM20-2X/XXX-H-K35.....	28
7 Installation.....	29
7.1 HCS01.....	29
7.1.1 Connection diagram of HCS01 power section.....	29
7.1.2 Connection diagram of control section.....	29
7.1.3 Connection points of HCS01 power section.....	30
7.1.4 Connection points of the control section.....	30
7.1.5 Documentation.....	30
7.2 HCS02.....	31
7.2.1 Connection diagram of HCS02 power section.....	31
7.2.2 Connection diagram of control section.....	31
7.2.3 Connection points of HCS02 power section.....	32
7.2.4 Connection points of the control section.....	32
7.2.5 Documentation.....	32
7.3 HCS03.....	33
7.3.1 Connection diagram of HCS03 power section.....	33
7.3.2 Connection diagram of control section.....	33
7.3.3 Connection points of HCS03 power section.....	34
7.3.4 Connection points of the control section.....	34
7.3.5 Documentation.....	34
7.4 HMS01.....	35
7.4.1 Connection diagram of HMS01 power section.....	35
7.4.2 Connection diagram of control section.....	35
7.4.3 Connection points of HMS01 power section.....	36
7.4.4 Connection points of the control section.....	36
7.4.5 Documentation.....	37
7.5 Control section.....	38
7.5.1 HCS01.....	38
Connection diagram of HCS01 control section.....	38
Connection points of HCS01 control section.....	40
7.5.2 CSB02/CSH02.....	41
Connection diagram of control section CSB02/CSH02.....	41
CSB02/CSH02 connection points of the control section.....	44
7.5.3 Connection points for master communication.....	45
Overview.....	45
PB - PROFIBUS.....	46
ET - Multi-Ethernet.....	50
CN - CANopen.....	52
7.6 Motor-pump unit.....	53

Table of Contents

	Page
8 Commissioning.....	55
8.1 System overview.....	55
8.2 Procedure.....	56
8.2.1 Notes.....	56
8.2.2 Commissioning the pump drive (motor control).....	56
8.2.3 Commissioning the pump.....	56
9 Operation.....	57
9.1 Injection molding control IMC.....	57
9.2 Operation modes.....	58
10 Servicing.....	59
10.1 System overview.....	59
10.2 Drive controllers.....	59
10.3 Motor-pump unit.....	60
11 Decommissioning.....	61
12 Replacing components.....	63
12.1 Disassembly.....	63
12.1.1 Preparing disassembly.....	63
12.1.2 Disassembly.....	63
12.2 Motor-pump unit.....	64
12.3 Drive controller.....	64
12.3.1 HCS01, HCS02, HCS03, HMS01.....	64
13 Environmental protection and disposal	65
13.1 Environmental protection.....	65
13.2 Disposal.....	65
14 Troubleshooting.....	67
14.1 How to proceed for troubleshooting.....	67
14.2 Diagnostic concept.....	67
Index.....	69

1 About this documentation

1.1 Validity of this documentation

This documentation applies to the variable speed pump drives, Sytronix 7020 and with drive controllers from the Rexroth IndraDrive range.

The content of this documentation focuses on information on the electric drive system.

For universal information on the Rexroth IndraDrive electric drive system see the amending documentations.

Motor-pump units are described in separate instruction manuals. These instruction manuals contain information on amending documentation (motors, pumps, hydraulic fluids, etc.).

Where required, this documentation may refer to the amending documentations.

1.2 Amending documentations

1.2.1 Sytronix SvP 7020

Title	Document type	Material number en (de)
Rexroth Sytronix SvP 7020 IMC, Variable-Speed Pump Drives	Commissioning Manual	R911376149 (R911376148)
Sytronix – speed variable pump drives ¹⁾	Product catalog	R999000332 (R999000331)

1) This documentation contains references to amending documentation for the individual components (motors, pumps, hydraulic fluids, etc.).

Tab. 1-1: Documentation, Sytronix SvP 7020

1.2.2 Motor-pump unit

Title	Document type	Material number en (de)
Rexroth Sytronix SvP 70xx Motor-Pump Unit MPA01 ¹⁾	Operating Instructions	R911339824 (R911339822)
Sytronix – speed variable pump drives ¹⁾	Product catalog	R999000332 (R999000331)
Sytronix 50xx/70xx Couplings, Bellhousing	Project Planning Manual	R911346865 (R911346864)

1) This documentation contains references to amending documentation for the individual components (motors, pumps, hydraulic fluids, etc.).

Tab. 1-2: Documentation, motor-pump units

About this documentation

1.2.3 Pressure transducer

Title	Document type	Material number en (de)
HM20-2X pressure transducer for hydraulic applications	Data Sheet	RE 30272 (RD 30272)

Tab. 1-3: Documentation, pressure transducer

1.2.4 Drive controllers

Title	Document type	Material number en (de)
Rexroth IndraDrive drive system	Product catalog	R999000019 (R999000018)
Rexroth IndraDrive Cs Drive Systems with HCS01	Project Planning Manual	R911322210 (R911322209)
Rexroth IndraDrive Drive Systems with HMV01/02 HMS01/02, HMD01, HCS02/03	Project Planning Manual	R911309636 (R911309635)
Rexroth IndraDrive Supply Units, Power Sections HMV, HMS, HMD, HCS02, HCS03	Project Planning Manual	R911318790 (R911318789)
Rexroth IndraDrive Additional Components and Accessories	Project Planning Manual	R911306140 (R911306139)
Rexroth IndraDrive Drive Controllers, Control Sections CSB02, CSE02, CSH02, CDB02	Project Planning Manual	R911338962 (R911338961)
Rexroth Connection Cables IndraDrive and IndraDyn	Selection data	R911322949 (R911322948)
Control Cabinet: Air Conditioning, EMC, Design, IP Code, Electrics IndraDrive, Rexroth Fv, Sytronix	Project Planning Manual	R911344988 (R911344987)

Tab. 1-4: Documentation, drive controllers

1.2.5 Firmware

Title	Kind of documentation	Material number en (de)
Rexroth IndraDrive ...		
MPx-20 Functions	Application Manual	R911345608 (R911345607)
MPx-20 Version Notes	Release Notes	R911345606 (R911345605)
Power Supply Basic PSB-20 Functions	Application Manual	R911345612 (R911345609)
MPx-16 to MPx-20 and PSB Parameters	Reference Book	R911328651 (R911328650)

About this documentation

Title Rexroth IndraDrive ...	Kind of documentation	Material number en (de)
MPx-16 to MPx-20 and PSB Diagnostic Messages	Reference Book	R911326738 (R911326539)
Integrated safety technology "Safe Torque Off" (from MPx-16)	Application Manual	R911332634 (R911332633)
Integrated safety technology "Safe Motion" (from MPx-18)	Application Manual	R911338920 (R911338919)
Rexroth IndraMotion MLD Libraries as of MPx-18	Reference Book	R911338916 (R911338915)
Rexroth IndraMotion MLD from MPx-18	Application Manual	R911338914 (R911338913)

Tab. 1-5: Documentations, firmware

2 Important directions for use

2.1 Appropriate use

2.1.1 Introduction

Rexroth products represent state-of-the-art developments and manufacturing. They are tested prior to delivery to ensure operating safety and reliability.

WARNING

Personal injury and property damage caused by incorrect use of the products!

The products have been designed for use in the industrial environment and may only be used in the appropriate way. If they are not used in the appropriate way, situations resulting in property damage and personal injury can occur.



Rexroth as manufacturer is not liable for any damages resulting from inappropriate use. In such cases, the guarantee and the right to payment of damages resulting from inappropriate use are forfeited. The user alone carries all responsibility of the risks.

Before using Rexroth products, make sure that all the pre-requisites for an appropriate use of the products are satisfied:

- Personnel that in any way, shape or form uses our products must first read and understand the relevant safety instructions and be familiar with their appropriate use.
- If the products take the form of hardware, then they must remain in their original state, in other words, no structural changes are permitted. It is not permitted to decompile software products or alter source codes.
- Do not install damaged or faulty products or put them into operation.
- Make sure that the products have been installed in the manner described in the relevant documentation.

2.1.2 Areas of use and application

Drive controllers made by Rexroth are designed to control electric motors and monitor their operation.

Control and monitoring of the Drive controllers may require additional sensors and actuators.



The drive controllers may only be used with the accessories and parts specified in this documentation. If a component has not been specifically named, then it may neither be mounted nor connected. The same applies to cables and lines.

Operation is only permitted in the specified configurations and combinations of components using the software and firmware as specified in the relevant Functional Descriptions.

Drive controllers have to be programmed before commissioning to ensure that the motor executes the specific functions of an application.

Drive controllers of the Rexroth IndraDrive series have been developed for use in single- and multi-axis drive and control tasks.

Important directions for use

To ensure application-specific use of Drive controllers, device types of different drive power and different interfaces are available.

Typical applications include, for example:

- Handling and mounting systems
- Packaging and food machines
- Printing and paper processing machines
- Machine tools

Drive controllers may only be operated under the assembly and installation conditions described in this documentation, in the specified position of normal use and under the ambient conditions as described (temperature, degree of protection, humidity, EMC, etc.).

2.2 Inappropriate use

Using the Drive controllers outside of the operating conditions described in this documentation and outside of the indicated technical data and specifications is defined as "inappropriate use".

Drive controllers may not be used, if ...

- they are subject to operating conditions that do not meet the specified ambient conditions. This includes, for example, operation under water, under extreme temperature fluctuations or extremely high maximum temperatures.
- Furthermore, Drive controllers may not be used in applications which have not been expressly authorized by Rexroth. Please carefully follow the specifications outlined in the general Safety Instructions!



Components of the Rexroth IndraDrive system are **products of Category C3** (with restricted distribution) in accordance with IEC 61800-3. This Category comprises EMC limit values for line-based and radiated noise emission. Compliance with this Category (limit values) requires the appropriate measures of interference suppression to be used in the drive system (e.g., mains filters, shielding measures).

These components are not provided for use in a public low-voltage mains supplying residential areas. If these components are used in such a mains, high-frequency interference is to be expected. This can require additional measures of interference suppression.

3 Safety instructions for electric drives and controls

3.1 Definitions of terms

Application documentation	Application documentation comprises the entire documentation used to inform the user of the product about the use and safety-relevant features for configuring, integrating, installing, mounting, commissioning, operating, maintaining, repairing and decommissioning the product. The following terms are also used for this kind of documentation: Operating Instructions, Commissioning Manual, Instruction Manual, Project Planning Manual, Application Description, etc.
Component	A component is a combination of elements with a specified function, which are part of a piece of equipment, device or system. Components of the electric drive and control system are, for example, supply units, drive controllers, mains choke, mains filter, motors, cables, etc.
Control system	A control system comprises several interconnected control components placed on the market as a single functional unit.
Device	A device is a finished product with a defined function, intended for users and placed on the market as an individual piece of merchandise.
Electrical equipment	Electrical equipment encompasses all devices used to generate, convert, transmit, distribute or apply electrical energy, such as electric motors, transformers, switching devices, cables, lines, power-consuming devices, circuit board assemblies, plug-in units, control cabinets, etc.
Electric drive system	An electric drive system comprises all components from mains supply to motor shaft; this includes, for example, electric motor(s), motor encoder(s), supply units and drive controllers, as well as auxiliary and additional components, such as mains filter, mains choke and the corresponding lines and cables.
Installation	An installation consists of several devices or systems interconnected for a defined purpose and on a defined site which, however, are not intended to be placed on the market as a single functional unit.
Machine	A machine is the entirety of interconnected parts or units at least one of which is movable. Thus, a machine consists of the appropriate machine drive elements, as well as control and power circuits, which have been assembled for a specific application. A machine is, for example, intended for processing, treatment, movement or packaging of a material. The term "machine" also covers a combination of machines which are arranged and controlled in such a way that they function as a unified whole.
Manufacturer	The manufacturer is an individual or legal entity bearing responsibility for the design and manufacture of a product which is placed on the market in the individual's or legal entity's name. The manufacturer can use finished products, finished parts or finished elements, or contract out work to subcontractors. However, the manufacturer must always have overall control and possess the required authority to take responsibility for the product.
Product	Examples of a product: Device, component, part, system, software, firmware, among other things.
Project Planning Manual	A Project Planning Manual is part of the application documentation used to support the sizing and planning of systems, machines or installations.
Qualified persons	In terms of this application documentation, qualified persons are those persons who are familiar with the installation, mounting, commissioning and operation of the components of the electric drive and control system, as well as with the hazards this implies, and who possess the qualifications their work

Safety instructions for electric drives and controls

requires. To comply with these qualifications, it is necessary, among other things,

- to be trained, instructed or authorized to switch electric circuits and devices safely on and off, to ground them and to mark them.
- to be trained or instructed to maintain and use adequate safety equipment.
- to attend a course of instruction in first aid.

User A user is a person installing, commissioning or using a product which has been placed on the market.

3.2 General information

3.2.1 Using the Safety instructions and passing them on to others

Do not attempt to install and operate the components of the electric drive and control system without first reading all documentation provided with the product. Read and understand these safety instructions and all user documentation prior to working with these components. If you do not have the user documentation for the components, contact your responsible Rexroth sales partner. Ask for these documents to be sent immediately to the person or persons responsible for the safe operation of the components.

If the component is resold, rented and/or passed on to others in any other form, these safety instructions must be delivered with the component in the official language of the user's country.

Improper use of these components, failure to follow the safety instructions in this document or tampering with the product, including disabling of safety devices, could result in property damage, injury, electric shock or even death.

3.2.2 Requirements for safe use

Read the following instructions before initial commissioning of the components of the electric drive and control system in order to eliminate the risk of injury and/or property damage. You must follow these safety instructions.

- Rexroth is not liable for damages resulting from failure to observe the safety instructions.
- Read the operating, maintenance and safety instructions in your language before commissioning. If you find that you cannot completely understand the application documentation in the available language, please ask your supplier to clarify.
- Proper and correct transport, storage, mounting and installation, as well as care in operation and maintenance, are prerequisites for optimal and safe operation of the component.
- Only qualified persons may work with components of the electric drive and control system or within its proximity.
- Only use accessories and spare parts approved by Rexroth.
- Follow the safety regulations and requirements of the country in which the components of the electric drive and control system are operated.
- Only use the components of the electric drive and control system in the manner that is defined as appropriate. See chapter "Appropriate Use".
- The ambient and operating conditions given in the available application documentation must be observed.

Safety instructions for electric drives and controls

- Applications for functional safety are only allowed if clearly and explicitly specified in the application documentation "Integrated Safety Technology". If this is not the case, they are excluded. Functional safety is a safety concept in which measures of risk reduction for personal safety depend on electrical, electronic or programmable control systems.
- The information given in the application documentation with regard to the use of the delivered components contains only examples of applications and suggestions.

The machine and installation manufacturers must

- make sure that the delivered components are suited for their individual application and check the information given in this application documentation with regard to the use of the components,
- make sure that their individual application complies with the applicable safety regulations and standards and carry out the required measures, modifications and complements.
- Commissioning of the delivered components is only allowed once it is sure that the machine or installation in which the components are installed complies with the national regulations, safety specifications and standards of the application.
- Operation is only allowed if the national EMC regulations for the application are met.
- The instructions for installation in accordance with EMC requirements can be found in the section on EMC in the respective application documentation.

The machine or installation manufacturer is responsible for compliance with the limit values as prescribed in the national regulations.

- The technical data, connection and installation conditions of the components are specified in the respective application documentations and must be followed at all times.

National regulations which the user has to comply with

- European countries: In accordance with European EN standards
- United States of America (USA):
 - National Electrical Code (NEC)
 - National Electrical Manufacturers Association (NEMA), as well as local engineering regulations
 - Regulations of the National Fire Protection Association (NFPA)
- Canada: Canadian Standards Association (CSA)
- Other countries:
 - International Organization for Standardization (ISO)
 - International Electrotechnical Commission (IEC)

3.2.3 Hazards by improper use

- High electrical voltage and high working current! Danger to life or serious injury by electric shock!
- High electrical voltage by incorrect connection! Danger to life or injury by electric shock!
- Dangerous movements! Danger to life, serious injury or property damage by unintended motor movements!

Safety instructions for electric drives and controls

- Health hazard for persons with heart pacemakers, metal implants and hearing aids in proximity to electric drive systems!
- Risk of burns by hot housing surfaces!
- Risk of injury by improper handling! Injury by crushing, shearing, cutting, hitting!
- Risk of injury by improper handling of batteries!
- Risk of injury by improper handling of pressurized lines!

3.3 Instructions with regard to specific dangers

3.3.1 Protection against contact with electrical parts and housings



This section concerns components of the electric drive and control system with voltages of **more than 50 volts**.

Contact with parts conducting voltages above 50 volts can cause personal danger and electric shock. When operating components of the electric drive and control system, it is unavoidable that some parts of these components conduct dangerous voltage.

High electrical voltage! Danger to life, risk of injury by electric shock or serious injury!

- Only qualified persons are allowed to operate, maintain and/or repair the components of the electric drive and control system.
- Follow the general installation and safety regulations when working on power installations.
- Before switching on, the equipment grounding conductor must have been permanently connected to all electric components in accordance with the connection diagram.
- Even for brief measurements or tests, operation is only allowed if the equipment grounding conductor has been permanently connected to the points of the components provided for this purpose.
- Before accessing electrical parts with voltage potentials higher than 50 V, you must disconnect electric components from the mains or from the power supply unit. Secure the electric component from reconnection.
- With electric components, observe the following aspects:
 - Always wait **30 minutes** after switching off power to allow live capacitors to discharge before accessing an electric component. Measure the electrical voltage of live parts before beginning to work to make sure that the equipment is safe to touch.
- Install the covers and guards provided for this purpose before switching on.
- Never touch any electrical connection points of the components while power is turned on.
- Do not remove or plug in connectors when the component has been powered.
- Under specific conditions, electric drive systems can be operated at mains protected by residual-current-operated circuit-breakers sensitive to universal current (RCDs/RCMs).

Safety instructions for electric drives and controls

- Secure built-in devices from penetrating foreign objects and water, as well as from direct contact, by providing an external housing, for example a control cabinet.

High housing voltage and high leakage current! Danger to life, risk of injury by electric shock!

- Before switching on and before commissioning, ground or connect the components of the electric drive and control system to the equipment grounding conductor at the grounding points.
- Connect the equipment grounding conductor of the components of the electric drive and control system permanently to the main power supply at all times. The leakage current is greater than 3.5 mA.
- Establish an equipment grounding connection with a minimum cross section according to the table below. With an outer conductor cross section smaller than 10 mm² (8 AWG), the alternative connection of two equipment grounding conductors is allowed, each having the same cross section as the outer conductors.

Cross section outer conductor	Minimum cross section equipment grounding conductor Leakage current ≥ 3.5 mA	
	1 equipment grounding conductor	2 equipment grounding conductors
1.5 mm ² (16 AWG)	10 mm ² (8 AWG)	2 × 1.5 mm ² (16 AWG)
2.5 mm ² (14 AWG)		2 × 2.5 mm ² (14 AWG)
4 mm ² (12 AWG)		2 × 4 mm ² (12 AWG)
6 mm ² (10 AWG)		2 × 6 mm ² (10 AWG)
10 mm ² (8 AWG)		-
16 mm ² (6 AWG)	16 mm ² (6 AWG)	-
25 mm ² (4 AWG)		-
35 mm ² (2 AWG)		-
50 mm ² (1/0 AWG)	25 mm ² (4 AWG)	-
70 mm ² (2/0 AWG)	35 mm ² (2 AWG)	-
...

Tab. 3-1: Minimum cross section of the equipment grounding connection

3.3.2 Protective extra-low voltage as protection against electric shock

Protective extra-low voltage is used to allow connecting devices with basic insulation to extra-low voltage circuits.

On components of an electric drive and control system provided by Rexroth, all connections and terminals with voltages up to 50 volts are PELV ("Protective Extra-Low Voltage") systems. It is allowed to connect devices equipped with basic insulation (such as programming devices, PCs, notebooks, display units) to these connections.

Safety instructions for electric drives and controls

Danger to life, risk of injury by electric shock! High electrical voltage by incorrect connection!

If extra-low voltage circuits of devices containing voltages and circuits of more than 50 volts (e.g., the mains connection) are connected to Rexroth products, the connected extra-low voltage circuits must comply with the requirements for PELV ("Protective Extra-Low Voltage").

3.3.3 Protection against dangerous movements

Dangerous movements can be caused by faulty control of connected motors. Some common examples are:

- Improper or wrong wiring or cable connection
- Operator errors
- Wrong input of parameters before commissioning
- Malfunction of sensors and encoders
- Defective components
- Software or firmware errors

These errors can occur immediately after equipment is switched on or even after an unspecified time of trouble-free operation.

The monitoring functions in the components of the electric drive and control system will normally be sufficient to avoid malfunction in the connected drives. Regarding personal safety, especially the danger of injury and/or property damage, this alone cannot be relied upon to ensure complete safety. Until the integrated monitoring functions become effective, it must be assumed in any case that faulty drive movements will occur. The extent of faulty drive movements depends upon the type of control and the state of operation.

Dangerous movements! Danger to life, risk of injury, serious injury or property damage!

A **risk assessment** must be prepared for the installation or machine, with its specific conditions, in which the components of the electric drive and control system are installed.

As a result of the risk assessment, the user must provide for monitoring functions and higher-level measures on the installation side for personal safety. The safety regulations applicable to the installation or machine must be taken into consideration. Unintended machine movements or other malfunctions are possible if safety devices are disabled, bypassed or not activated.

To avoid accidents, injury and/or property damage:

- Keep free and clear of the machine's range of motion and moving machine parts. Prevent personnel from accidentally entering the machine's range of motion by using, for example:
 - Safety fences
 - Safety guards
 - Protective coverings
 - Light barriers
- Make sure the safety fences and protective coverings are strong enough to resist maximum possible kinetic energy.
- Mount emergency stopping switches in the immediate reach of the operator. Before commissioning, verify that the emergency stopping equip-

Safety instructions for electric drives and controls

ment works. Do not operate the machine if the emergency stopping switch is not working.

- Prevent unintended start-up. Isolate the drive power connection by means of OFF switches/OFF buttons or use a safe starting lockout.
- Make sure that the drives are brought to safe standstill before accessing or entering the danger zone.
- Additionally secure vertical axes against falling or dropping after switching off the motor power by, for example,
 - mechanically securing the vertical axes,
 - adding an external braking/arrester/clamping mechanism or
 - ensuring sufficient counterbalancing of the vertical axes.
- The standard equipment **motor holding brake** or an external holding brake controlled by the drive controller is **not sufficient to guarantee personal safety!**
- Disconnect electrical power to the components of the electric drive and control system using the master switch and secure them from reconnection ("lock out") for:
 - Maintenance and repair work
 - Cleaning of equipment
 - Long periods of discontinued equipment use
- Prevent the operation of high-frequency, remote control and radio equipment near components of the electric drive and control system and their supply leads. If the use of these devices cannot be avoided, check the machine or installation, at initial commissioning of the electric drive and control system, for possible malfunctions when operating such high-frequency, remote control and radio equipment in its possible positions of normal use. It might possibly be necessary to perform a special electromagnetic compatibility (EMC) test.

3.3.4 Protection against electromagnetic and magnetic fields during operation and mounting

Electromagnetic and magnetic fields!

Health hazard for persons with active implantable medical devices (AIMD) such as pacemakers or passive metallic implants.

- Hazards for the above-mentioned groups of persons by electromagnetic and magnetic fields in the immediate vicinity of drive controllers and the associated current-carrying conductors.
- Entering these areas can pose an increased risk to the above-mentioned groups of persons. They should seek advice from their physician.
- If overcome by possible effects on above-mentioned persons during operation of drive controllers and accessories, remove the exposed persons from the vicinity of conductors and devices.

3.3.5 Protection against contact with hot parts

Hot surfaces of components of the electric drive and control system. Risk of burns!

Safety instructions for electric drives and controls

- Do not touch hot surfaces of, for example, braking resistors, heat sinks, supply units and drive controllers, motors, windings and laminated cores!
- According to the operating conditions, temperatures of the surfaces can be **higher than 60 °C** (140 °F) during or after operation.
- Before touching motors after having switched them off, let them cool down for a sufficient period of time. Cooling down can require **up to 140 minutes!** The time required for cooling down is approximately five times the thermal time constant specified in the technical data.
- After switching chokes, supply units and drive controllers off, wait **15 minutes** to allow them to cool down before touching them.
- Wear safety gloves or do not work at hot surfaces.
- For certain applications, and in accordance with the respective safety regulations, the manufacturer of the machine or installation must take measures to avoid injuries caused by burns in the final application. These measures can be, for example: Warnings at the machine or installation, guards (shieldings or barriers) or safety instructions in the application documentation.

3.3.6 Protection during handling and mounting

Risk of injury by improper handling! Injury by crushing, shearing, cutting, hitting!

- Observe the relevant statutory regulations of accident prevention.
- Use suitable equipment for mounting and transport.
- Avoid jamming and crushing by appropriate measures.
- Always use suitable tools. Use special tools if specified.
- Use lifting equipment and tools in the correct manner.
- Use suitable protective equipment (hard hat, safety goggles, safety shoes, safety gloves, for example).
- Do not stand under hanging loads.
- Immediately clean up any spilled liquids from the floor due to the risk of falling!

3.3.7 Battery safety

Batteries consist of active chemicals in a solid housing. Therefore, improper handling can cause injury or property damage.

Risk of injury by improper handling!

- Do not attempt to reactivate low batteries by heating or other methods (risk of explosion and cauterization).
- Do not attempt to recharge the batteries as this may cause leakage or explosion.
- Do not throw batteries into open flames.
- Do not dismantle batteries.
- When replacing the battery/batteries, do not damage the electrical parts installed in the devices.
- Only use the battery types specified for the product.



Environmental protection and disposal! The batteries contained in the product are considered dangerous goods during land, air, and sea transport (risk of explosion) in the sense of the legal regulations. Dispose of used batteries separately from other waste. Observe the national regulations of your country.

3.3.8 Protection against pressurized systems

According to the information given in the Project Planning Manuals, motors and components cooled with liquids and compressed air can be partially supplied with externally fed, pressurized media, such as compressed air, hydraulics oil, cooling liquids and cooling lubricants. Improper handling of the connected supply systems, supply lines or connections can cause injuries or property damage.

Risk of injury by improper handling of pressurized lines!

- Do not attempt to disconnect, open or cut pressurized lines (risk of explosion).
- Observe the respective manufacturer's operating instructions.
- Before dismantling lines, relieve pressure and empty medium.
- Use suitable protective equipment (safety goggles, safety shoes, safety gloves, for example).
- Immediately clean up any spilled liquids from the floor due to the risk of falling!



Environmental protection and disposal! The agents (e.g., fluids) used to operate the product might not be environmentally friendly. Dispose of agents harmful to the environment separately from other waste. Observe the national regulations of your country.

Safety instructions for electric drives and controls

3.4 Explanation of signal words and the Safety alert symbol

The Safety Instructions in the available application documentation contain specific signal words (DANGER, WARNING, CAUTION or NOTICE) and, where required, a safety alert symbol (in accordance with ANSI Z535.6-2011).

The signal word is meant to draw the reader's attention to the safety instruction and identifies the hazard severity.

The safety alert symbol (a triangle with an exclamation point), which precedes the signal words DANGER, WARNING and CAUTION, is used to alert the reader to personal injury hazards.

DANGER

In case of non-compliance with this safety instruction, death or serious injury **will** occur.

WARNING

In case of non-compliance with this safety instruction, death or serious injury **could** occur.

CAUTION

In case of non-compliance with this safety instruction, minor or moderate injury could occur.

NOTICE

In case of non-compliance with this safety instruction, property damage could occur.

4 Speed variable Sytronix pump drives

4.1 Overview

	SvP 7020
System function FWS-MLDSYT-...	IMC02 (p/Q control)
Drive firmware FWA-MPx-yyVRS	MPB-20VRS MPC-20VRS
Control section	CSB02.1 CSH02.1 HCS01.1 ... -B-ET HCS01.1 ... -A-CC
Power section	IndraDrive C IndraDrive M IndraDrive Cs
Motor	Synchronous motor (MSK) Synchronous motor (MS2N)
Pump	PGH
Motor-pump unit	MPA01 MPA02

Tab. 4-1: Sytronix SvP 7020

Speed variable Sytronix pump drives

4.2 Sytronix SvP 7020

4.2.1 Overview of components

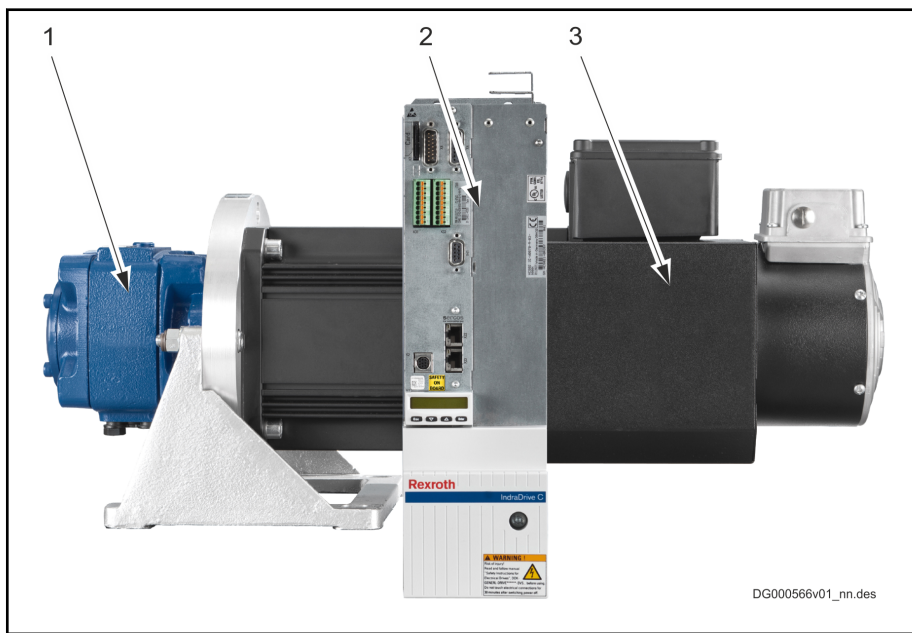

- 1 Pump (internal gear pump PGH)
- 2 Drive controller (HCS01, HCS02, HCS03, HMS01 or HMS02); shown here: HCS02
- 3 Synchronous motor (IndraDyn MSK or MS2N with air or water cooling)
- 1 + 3 MPA01 or MPA02 motor-pump unit; MPA0x: Motor-pump unit with direct coupling

Fig. 4-1: Sytronix SvP 7020

SvP "SvP" means "Servo variable Pump".

SvP systems are suitable for use in open and in closed hydraulic systems for hydraulic axis control (e.g. injection molding machines).

4.2.2 System function

Drive controller	System function
HCS01	FWS-MLDSYT-IMC-02VRS-D0-MP20
HCS02	
HCS03	
HMS01	
HMS02	

IMC Injection Molding Control

Tab. 4-2: System function

Speed variable Sytronix pump drives

4.2.3 IMC device configuration

IndraDrive C, IndraDrive M

Firmware	Control section CSx02.1x-xx-EC-xx-xx-xx						Communication	Pressure transducer	Command value
	CSx02.1x	xx	EC	xx	xx	xx			
MPC20	CSH02.1B	CC	EC	NN	xx	DA	Analog	X32	Analog
MPC20	CSH02.1B	CC	EC	ET	xx	xx	Multi-Ethernet	X32	Field bus
MPC20	CSH02.1B	CC	EC	PB	xx	xx	PROFIBUS	X32	Field bus
MPC20	CSH02.1B	ET	EC	NN	xx	xx	Multi-Ethernet	X32	Field bus
MPC20	CSH02.1B	ET	EC	NN	xx	DA	Analog	X32	Analog
MPB20	CSB02.1B	ET	EC	NN	xx	xx	Multi-Ethernet	X32	Field bus
MPB20	CSB02.1B	ET	EC	PB	xx	xx	PROFIBUS	X32	Field bus
MPB20	CSB02.1B	ET	EC	NN	xx	DA	Analog	X32	Analog
MPB20	CSB02.1B	ET	EC	NN	xx	NN	Analog	X32	Analog
MPB20	CSB02.1A	ET	EC	NN	xx	xx	Multi-Ethernet	X32	Field bus
MPB20	CSB02.1A	ET	EC	PB	xx	xx	PROFIBUS	X32	Field bus

Tab. 4-3: IndraDrive C, IndraDrive M

IndraDrive Cs

Firmware	Drive controller HCS01.1E-W****-A0*-x-xx-EC-xx				Communication	Pressure transducer	Command value
	HCS01.1E-W****-A0*	x-xx	EC	xx			
MPC20	HCS01.1E-W****-A0*	A-CC	EC	ET	Multi-Ethernet	X32	Field bus
MPC20	HCS01.1E-W****-A0*	A-CC	EC	PB	PROFIBUS	X32	Field bus
MPC20	HCS01.1E-W****-A0*	A-CC	EC	DA	Analog	X32	Analog
MPB20	HCS01.1E-W****-A0*	B-ET	EC	NN	Multi-Ethernet	X32	Field bus
MPB20	HCS01.1E-W****-A0*	B-ET	EC	PB	PROFIBUS	X32	Field bus
MPB20	HCS01.1E-W****-A0*	B-ET	EC	DA	Analog	X32	Analog

Tab. 4-4: IndraDrive Cs

Speed variable Sytronix pump drives

4.2.4 Documentation

Title	Document type	Material number en (de)
Sytronix – speed variable pump drives ¹⁾	Product catalog	R999000332 (R999000331)
Rexroth Sytronix SvP 70xx Motor-Pump Unit MPA01 ¹⁾	Operating Instructions	R911339824 (R911339822)
Rexroth IndraDrive drive system	Product catalog	R999000019 (R999000018)

1) This documentation contains references to amending documentation for the individual components (motors, pumps, hydraulic fluids, etc.).

Tab. 4-5: *Documentation, motor-pump units*

5 Transport and storage

5.1 Drive controllers

See documentation of the component:

Title	Document type	Material number en (de)
Rexroth IndraDrive Cs Drive Systems with HCS01	Project Planning Manual	R911322210 (R911322209)
Rexroth IndraDrive Supply Units, Power Sections HMV, HMS, HMD, HCS02, HCS03	Project Planning Manual	R911318790 (R911318789)
Rexroth IndraDrive Additional Components and Accessories	Project Planning Manual	R911306140 (R911306139)

Tab. 5-1: Documentation, drive controllers

5.2 Motor-pump unit

See documentation of the component:

Title	Document type	Material number en (de)
Rexroth Sytronix SvP 70xx Motor-Pump Unit MPA01 ¹⁾	Operating Instructions	R911339824 (R911339822)
HM20-2X pressure transducer for hydraulic applications	Data sheet	RE 30272 (RD 30272)

1) This documentation contains references to amending documentation for the individual components (motors, pumps, hydraulic fluids, etc.).

Tab. 5-2: Documentation, motor-pump units

6 Assembly

6.1 Drive controllers

See documentation of the component:

Title	Document type	Material number en (de)
Rexroth IndraDrive Cs Drive Systems with HCS01	Project Planning Manual	R911322210 (R911322209)
Rexroth IndraDrive Supply Units, Power Sections H MV, H MS, H MD, H CS02, H CS03	Project Planning Manual	R911318790 (R911318789)
Rexroth IndraDrive Additional Components and Accessories	Project Planning Manual	R911306140 (R911306139)
Control Cabinet: Air Conditioning, EMC, Design, IP Code, Electrics IndraDrive, Rexroth Fv, Sytronix	Project Planning Manual	R911344988 (R911344987)

Tab. 6-1: Documentation, drive controllers

6.2 Motor-pump unit

See documentation of the component:

Title	Document type	Material number en (de)
Rexroth Sytronix SvP 70xx Motor-Pump Unit MPA01 ¹⁾	Operating Instructions	R911339824 (R911339822)
HM20-2X pressure transducer for hydraulic applications	Data sheet	RE 30272 (RD 30272)

- 1) This documentation contains references to amending documentation for the individual components (motors, pumps, hydraulic fluids, etc.).

Tab. 6-2: Documentation, motor-pump units

Assembly

6.3 Pressure transducer HM20-2X/XXX-H-K35

- Assemble the pressure transducer in **suspended position** (hydraulic connection at the top). In this position the pressure transducer is optimally ventilated.
- **Do not install an additional valve** in the line between the pump and the pressure transducer.
- Connect a pressure transducer with a **sufficient line diameter** (no minimum connections!).

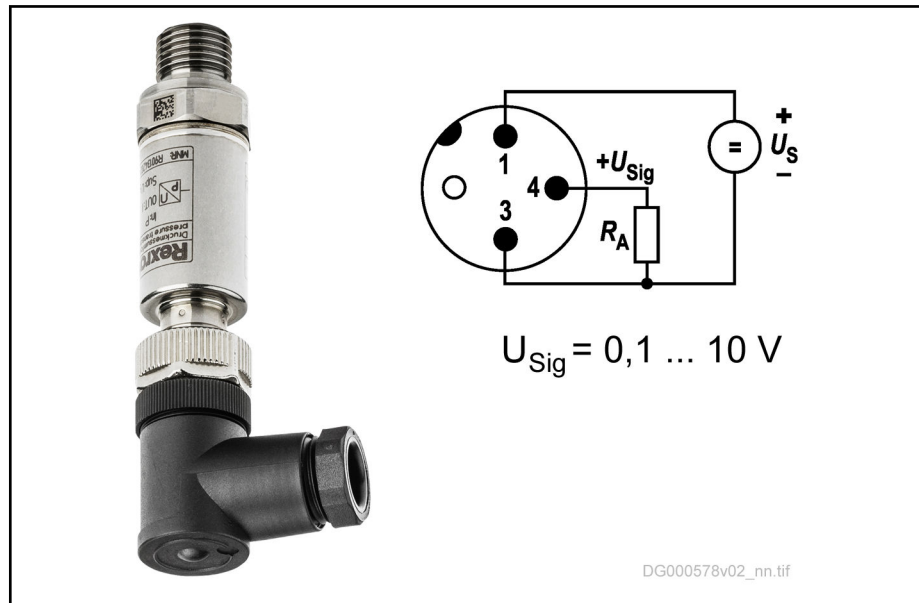

Fig. 6-1: Pressure transducer HM20-2X/XXX-H-K35 (with voltage output) and flange socket (angled, 4-pin, M12x1)

Connection of pressure transducer on the control section:

See [chapter 7.5 "Control section" on page 38](#).

See documentation of the component:

Title	Document type	Material number en (de)
HM20-2X pressure transducer for hydraulic applications	Data sheet	RE 30272 (RD 30272)

Tab. 6-3: Documentation, pressure transducer

7 Installation

7.1 HCS01

7.1.1 Connection diagram of HCS01 power section

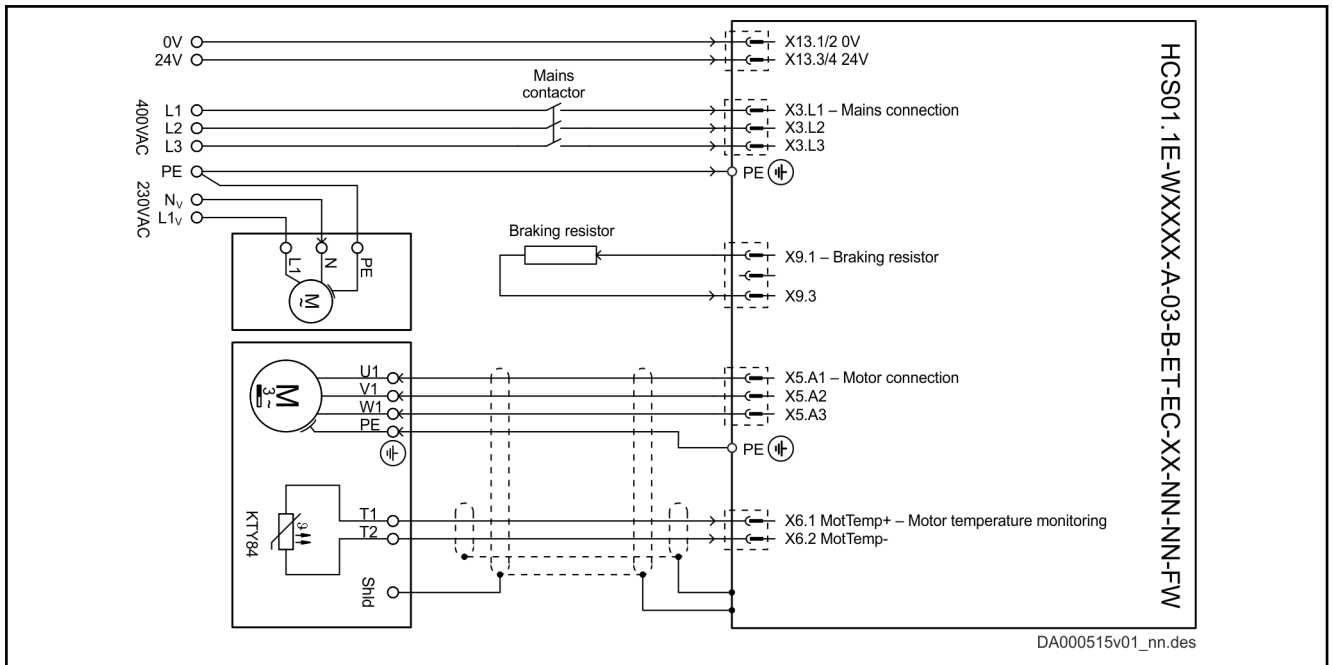







Fig. 7-1: Connection diagram of HCS01 power section

7.1.2 Connection diagram of control section

















See chapter "Connection diagram of HCS01 control section" on page 38.

Installation

7.1.3 Connection points of HCS01 power section

Symbols that describe the connection points					
Screw terminal block	Spring terminal	Thread	Max. connection cross section	Stripping length	Max. tightening torque
					

Tab. 7-1: Symbols

Connection point	HCS01	  	 mm ² (AWG)	 mm	 Nm
	A, B, C		M5	-	5
X3	A ¹⁾		2.5 (14)	8	0.6
	B ²⁾		6.0 (10)	10	0.8
	C ³⁾		10.0 (8)	14	1.7
X5	A		2.5 (14)	8	0.6
	B		6.0 (10)	10	0.8
	C		10.0 (8)	14	1.7
X6	A, B, C		1.5 (16)	10	-
X9	A, B, C	- ⁵⁾	-	-	-
X13	A, B, C		2.5 (14)	10	-

- 1) A: HCS01.1E-W0003...W0013-x-02, -W0005-x-03, -W0008-x-03
 2) B: HCS01.1E-W0018-x-02, -W0018-x-03, -W0028-x-03
 3) C: HCS01.1E-W0054-x-03
 4) D: HCS01.1E-W00xx-x-03
 5) Connector available at the braking resistor

Tab. 7-2: Connection points

7.1.4 Connection points of the control section

See [chapter "Connection points of HCS01 control section" on page 40.](#)

7.1.5 Documentation

Title	Document type	Material number en (de)
Rexroth IndraDrive Cs Drive Systems with HCS01	Project Planning Manual	R911322210 (R911322209)

Tab. 7-3: Documentation, drive controllers

7.2 HCS02

7.2.1 Connection diagram of HCS02 power section

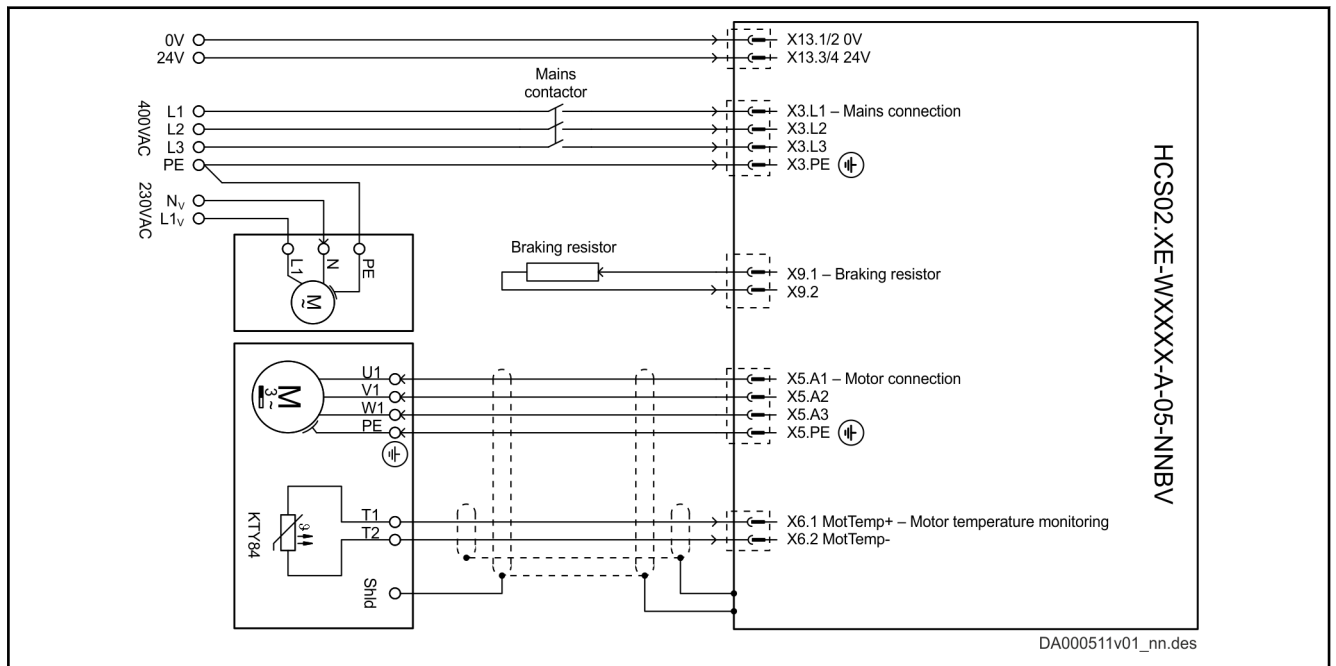

Fig. 7-2: Connection diagram of HCS02 power section

7.2.2 Connection diagram of control section

See chapter "Connection diagram of control section CSB02/CSH02" on page 41.

Installation

7.2.3 Connection points of HCS02 power section

Symbols that describe the connection points				
Screw terminal block	Spring terminal	Thread	Max. connection cross section	Max. tightening torque
⊗	→	■	∅	C

Tab. 7-4: Symbols

Connection point	HCS02	⊗ → ■	∅ mm ² (AWG)	C Nm
X3, X5, ⊕	A, B ¹⁾²⁾	⊗	4.0 (10)	0.6
	C ³⁾	⊗	16.0 (6)	1.7
X6	A, B, C	→	1.5 (16)	-
X9	B, C	⊗	4.0 (10)	1.7
X13	A, B, C	→	1.5 (16)	-
L+, L-	B, C	■	M6	6.5

- 1) A: HCS02.1E-W0012
 2) B: HCS02.1E-W0028
 3) C: HCS02.1E-W0054, -W0070

Tab. 7-5: Connection points

7.2.4 Connection points of the control section

See [chapter "CSB02/CSH02 connection points of the control section" on page 44.](#)

7.2.5 Documentation

Title	Document type	Material number en (de)
Rexroth IndraDrive supply units, power sections HMV, HMS, HMD, HCS02, HCS03	Project Planning Manual	R911318790 (R911318789)
Rexroth IndraDrive Drive Controllers, Control Sections CSB02, CSE02, CSH02, CDB02	Project Planning Manual	R911338962 (R911338961)

Tab. 7-6: Documentation, drive controllers

7.3 HCS03

7.3.1 Connection diagram of HCS03 power section

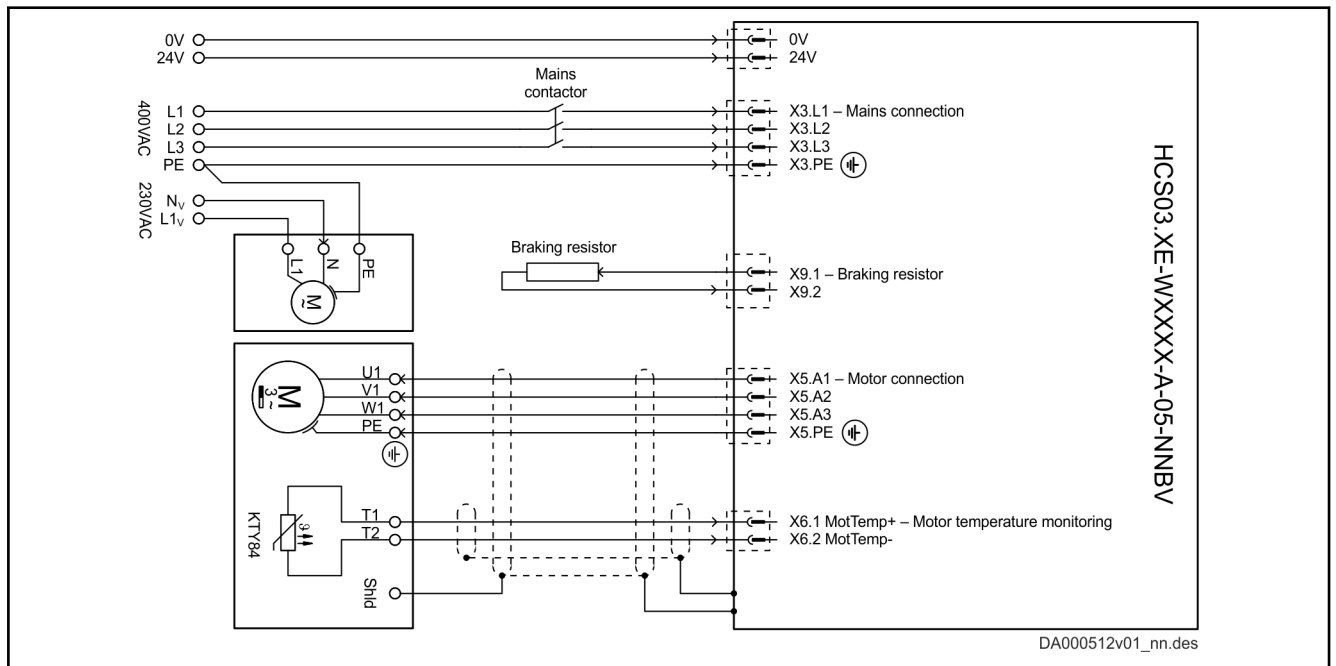







Fig. 7-3: Connection diagram of HCS03 power section

7.3.2 Connection diagram of control section











See chapter "Connection diagram of control section CSB02/CSH02" on page 41

Installation

7.3.3 Connection points of HCS03 power section

Symbols that describe the connection points				
Screw terminal block	Spring terminal	Thread	Max. connection cross section	Max. tightening torque
				

Tab. 7-7: Symbols

Connection point	HCS03	  	 mm ² (AWG)	 Nm
X3	A ¹⁾		16.0 (6)	1.7
X5 	B ²⁾		M6 1×16; 1×25; 1×35; 1×50 2×25; 2×35; 2×50 2×16 with accessories (1×6; 1×4; 1×2; 1×1 2×4; 2×2; 2×1 2×6 with accessories)	6.5
X6	A, B		1.5 (16)	-
X9	A, B		16.0 (6)	1.7
24V, 0V L+, L-	A, B		M6	6.5

1) A: HCS03.1E-W0070
2) B: HCS02.1E-W0100...W0210
Tab. 7-8: Connection points

7.3.4 Connection points of the control section

See [chapter "CSB02/CSH02 connection points of the control section" on page 44.](#)

7.3.5 Documentation

Title	Document type	Material number en (de)
Rexroth IndraDrive Supply Units, Power Sections HMV, HMS, HMD, HCS02, HCS03	Project Planning Manual	R911318790 (R911318789)
Rexroth IndraDrive Drive Controllers, Control Sections CSB02, CSE02, CSH02, CDB02	Project Planning Manual	R911338962 (R911338961)

Tab. 7-9: Documentation, drive controllers

7.4 HMS01

7.4.1 Connection diagram of HMS01 power section

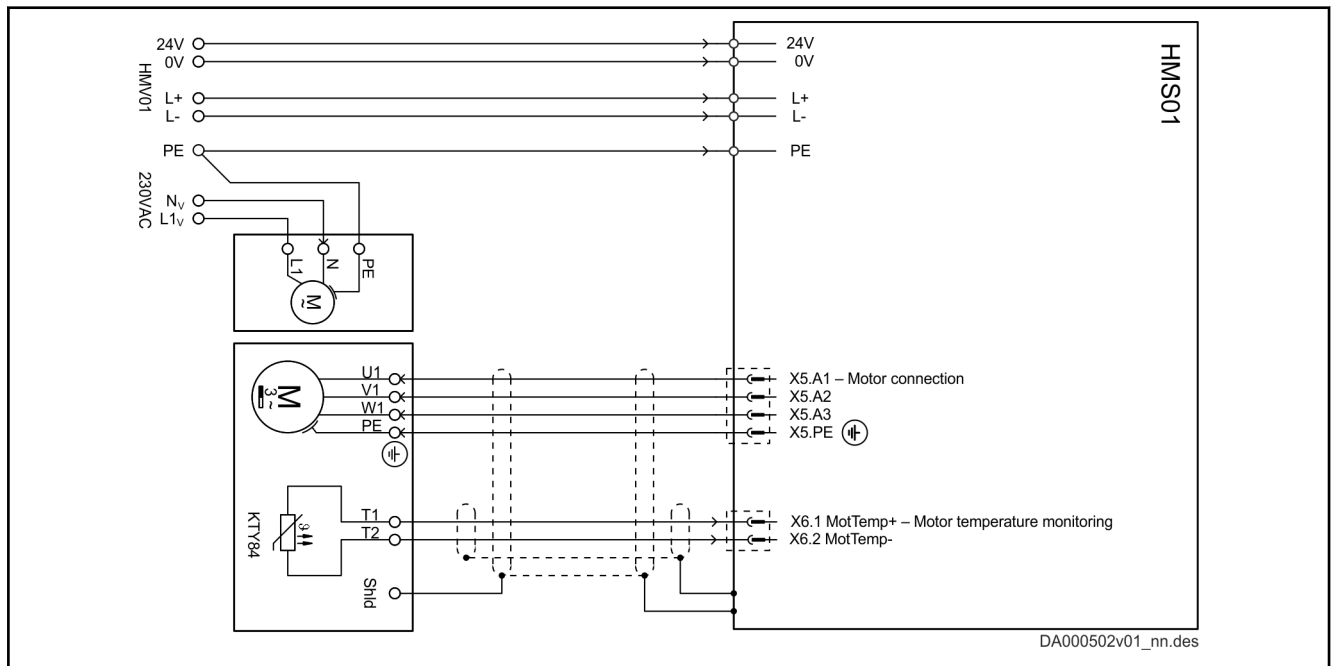







Fig. 7-4: Connection diagram of HMS01 power section

7.4.2 Connection diagram of control section















See chapter "Connection diagram of control section CSB02/CSH02" on page 41

Installation

7.4.3 Connection points of HMS01 power section

Symbols that describe the connection points				
Screw terminal block	Spring terminal	Thread	Max. connection cross section	Max. tightening torque
				

Tab. 7-10: Symbols

Connection point	HMS01	 	 mm ² (AWG)	 Nm
X5	A ¹⁾		4.0 (10)	0.6
	B ²⁾		16.0 (6)	1.7
	C ³⁾		M6 1×16; 1×25; 1×35 2×16; 2×25; 2×35 (1×6; 1×4; 1×2; 1×1 2×6; 2×4; 2×2; 2×1)	6.5
	D ⁴⁾		M6 1×16; 1×25; 1×35; 1×50 2×16; 2×25; 2×35; 2×50 (1×6; 1×4; 1×2; 1×1 2×6; 2×4; 2×2; 2×1)	6.5
	E ⁵⁾		M10 1×16; 1×25; 1×35; 1×50; 1×70; 1×120 2×16; 2×25; 2×35; 2×50; 2×70; 2×120 (1×6; 1×4; 1×2; 1×1; 1×1/0; 1×2/0; 1×4/0 2×6; 2×4; 2×2; 2×1; 2×1/0; 2×2/0; 2×4/0)	20
X6	A, B, C, D, E		1.5 (16)	-
24V, 0V L+, L-	A, B, C, D, E		M6	6.5
	A, B		4.0 (10)	0.6
	C, D, E		M6	6.0

- 1) A: HMS01.1N-W0020, -W0036
 2) B: HMS01.1N-W0054, -W0070
 3) C: HMS01.1N-W0110
 4) D: HMS01.1N-W0150, -W0210, -W0300
 5) E: HMS01.1N-W0350

Tab. 7-11: Connection points

7.4.4 Connection points of the control section

See [chapter "CSB02/CSH02 connection points of the control section" on page 44.](#)

7.4.5 Documentation

Title	Document type	Material number en (de)
Rexroth IndraDrive Cs Drive Systems with HCS01	Project Planning Manual	R911322210 (R911322209)
Rexroth IndraDrive Supply Units, Power Sections HMV, HMS, HMD, HCS02, HCS03	Project Planning Manual	R911318790 (R911318789)
Rexroth IndraDrive Drive Controllers, Control Sections CSB02, CSE02, CSH02, CDB02	Project Planning Manual	R911338962 (R911338961)

Tab. 7-12: Documentation, drive controllers

Installation

7.5 Control section

7.5.1 HCS01

Connection diagram of HCS01 control section

Injection molding control (IMC system function)

HCS01 with master communication, IMC system function

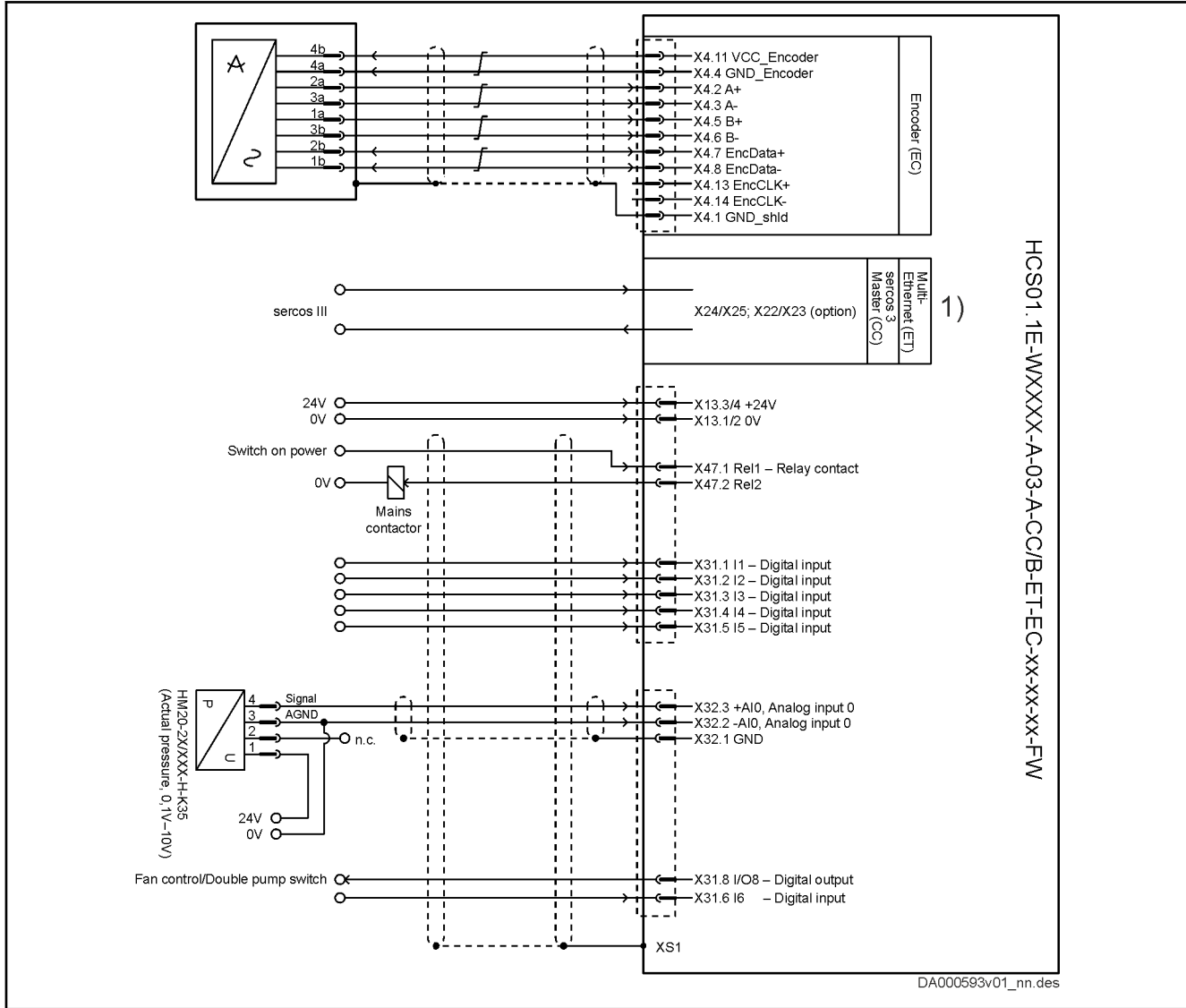

1) Connection of other master communications: See [chapter 7.5.3 "Connection points for master communication"](#) on page 45

Fig. 7-5: HCS01 control section connection diagram with master communication, IMC system function

HCS01 without master communication, with DA option, IMC system function

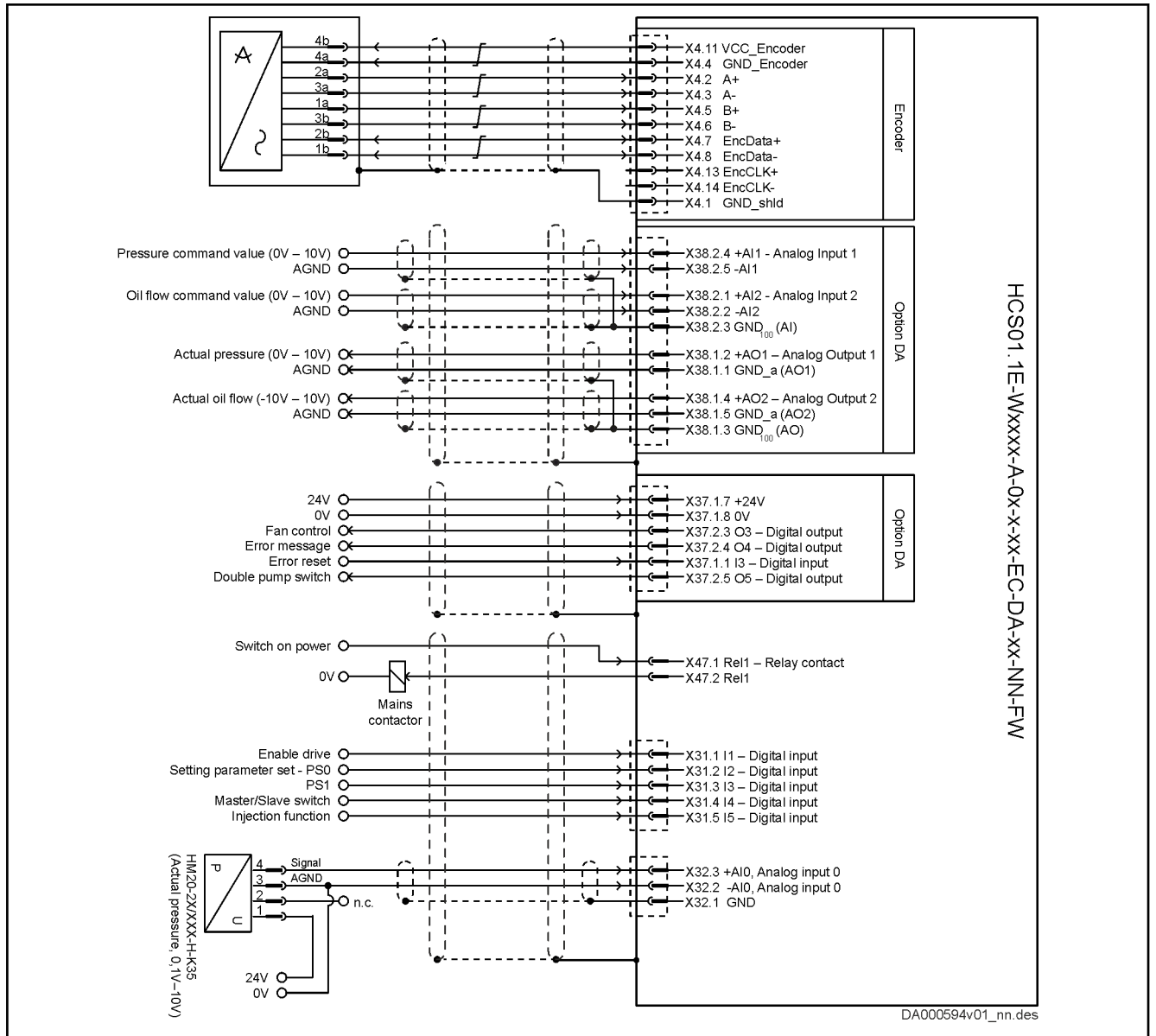















Fig. 7-6: HCS01 control section connection diagram without master communication, with DA option, IMC system function

Installation

Connection points of HCS01 control section

Symbols that describe the connection points					
Spring Terminal	D-Sub	RJ-45	Max. connection cross section	Stripping length	Max. tightening torque
→			∅		

Tab. 7-13: Symbols

Connection point	HCS01	→  	∅ mm ² (AWG)	 mm	 Nm
X4	A ¹⁾ , B ¹⁾ , C ¹⁾		-	-	-
X13	A, B, C	→	2.5 (14)	10	-
X22 P2, X23 P1	A, B, C		-	-	-
X24 P2, X25 P1	A, B, C		-	-	-
X30	A, B, C		-	-	-
X31	A, B, C	→	1.5 (16)	10	-
X32	A, B, C	→	1.5 (16)	10	-
X47	A, B, C	→	1.5 (16)	10	-
X61	A, B, C		-	-	-

- 1) **A:** HCS01.1E-W0003...W0013-x-02, -W0005-x-03, -W0008-x-03
 2) **B:** HCS01.1E-W0018-x-02, -W0018-x-03, -W0028-x-03
 3) **C:** HCS01.1E-W0054-x-03

Tab. 7-14: Connection points of HCS01 control section

7.5.2 CSB02/CSH02

Connection diagram of control section CSB02/CSH02

Injection molding control (IMC system function)

CSB02.1A with master communication, System function IMC

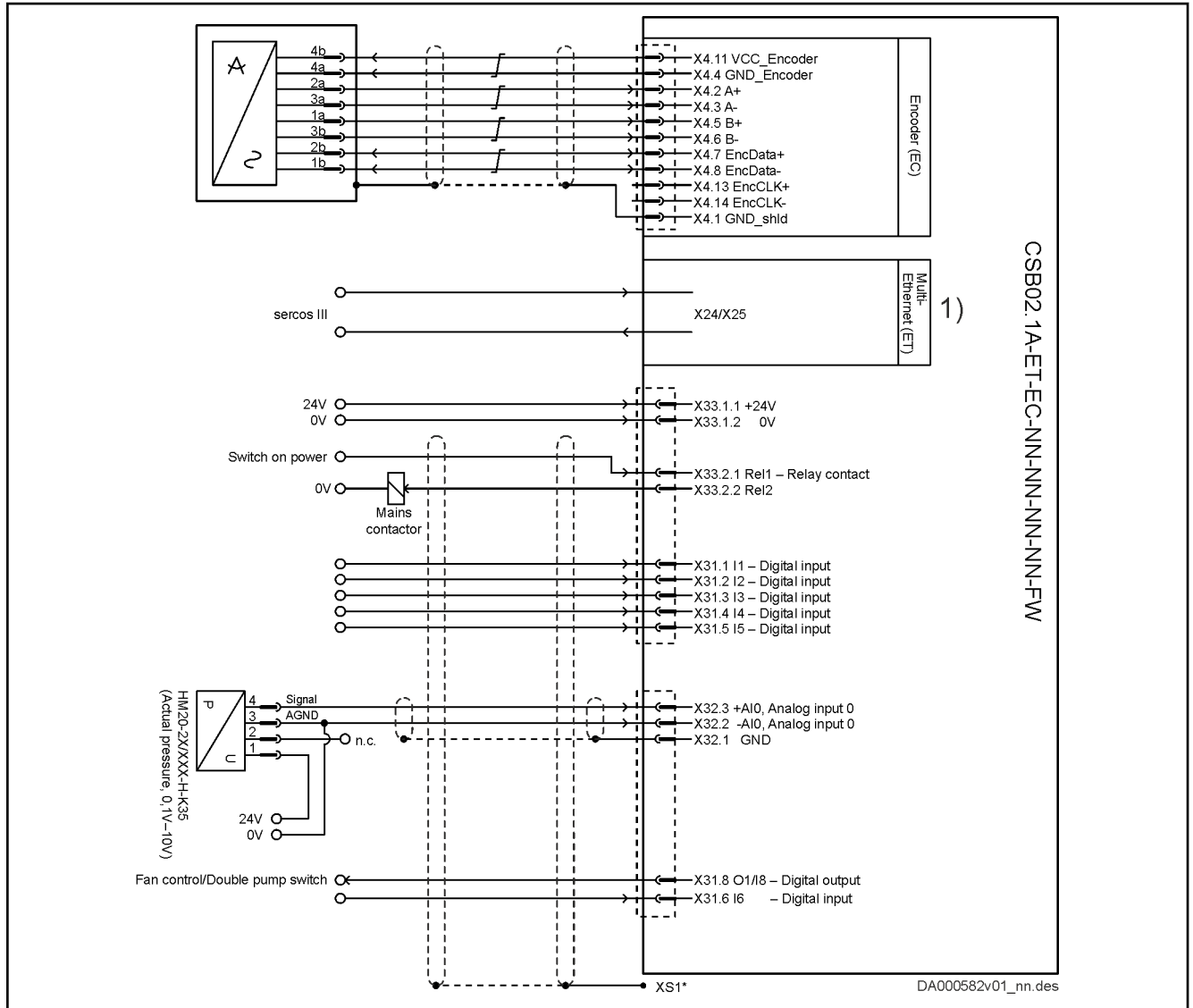

1) Connection of other master communications: See [chapter 7.5.3 "Connection points for master communication" on page 45](#)

* Shield connection on power section

Fig. 7-7: CSB02.1A connection diagram with master communication, IMC system function

Installation

**CSB02.1B/CSH02.1B without master communication, with option DA,
 system function IMC**

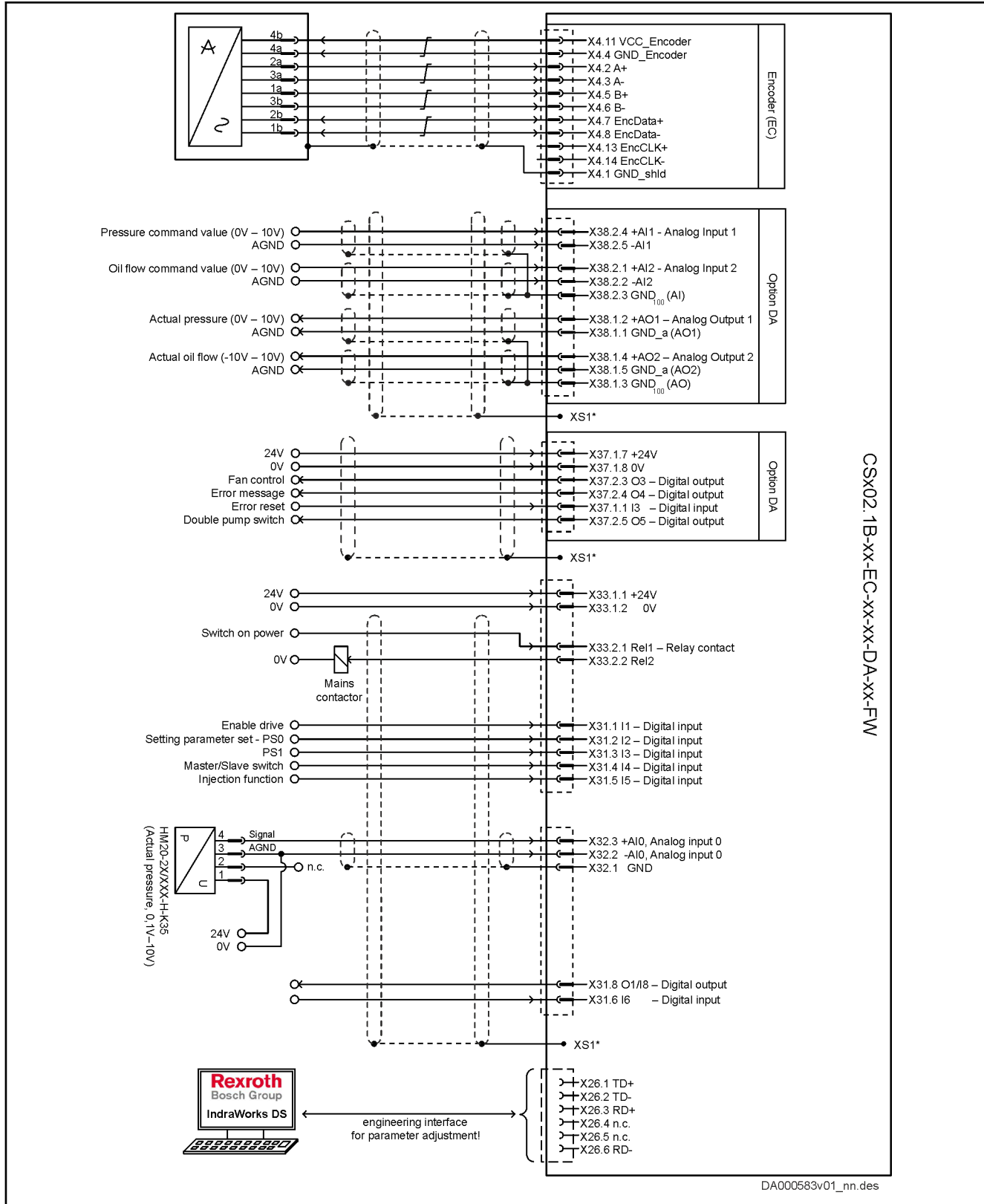

* Shield connection on power section
 Fig. 7-8: CSB02.1B/CSH02.1B connection diagram without master communication, with DA option, IMC system function

CSB02.1B/CSH02.1B with master communication, without DA option, IMC system function

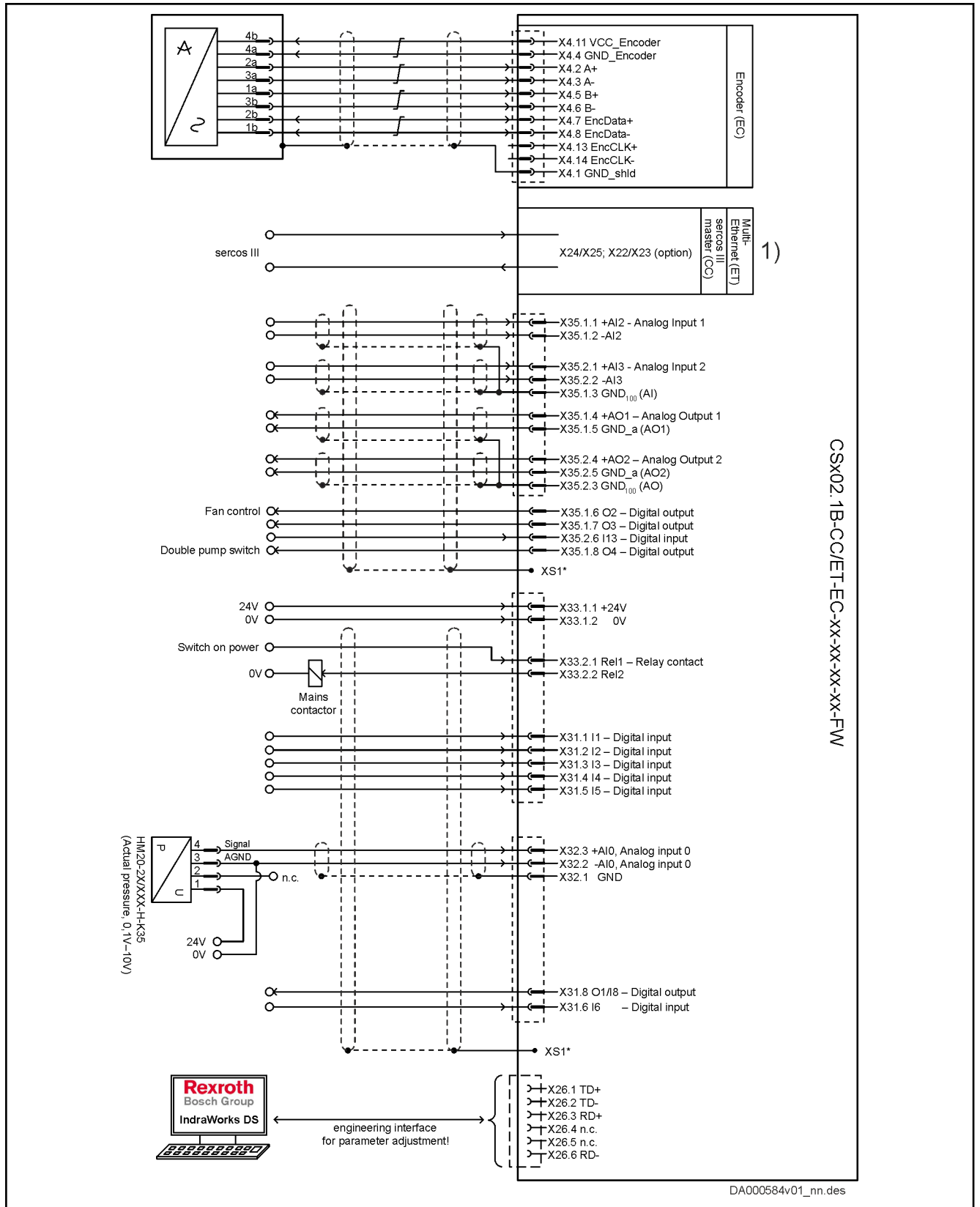

1)

Connection of other master communications: See [chapter 7.5.3 "Connection points for master communication"](#) on page

Installation

45



*

Shield connection on power section









Fig. 7-9:

CSB02.1B/CSH02.1B connection diagram with master communication, without DA option, IMC system function

CSB02/CSH02 connection points of the control section

Symbols that describe the connection points			
Spring Terminal	D-Sub	RJ	Max. connection cross section
→			∅

Tab. 7-15: Symbols

Connection point	→  	∅ mm ² (AWG)
X4		-
X10		-
X22 P2, X23 P1		-
X24 P2, X25 P1		-
X26		-
X30		-
X31	→	1.5 (16)
X32	→	1.5 (16)
X35	→	1.5 (16)
X36	→	1.5 (16)
X37	→	1.5 (16)
X38	→	1.5 (16)
X61		-

Tab. 7-16: Connection points

Title	Document type	Material number en (de)
Rexroth IndraDrive Drive Controllers, Control Sections CSB02, CSE02, CSH02, CDB02	Project Planning Manual	R911338962 (R911338961)

Tab. 7-17: Documentation, drive controllers

7.5.3 Connection points for master communication

Overview

Master communication	Description
Multi-Ethernet	X24/X25 connection point See chapter "ET - Multi-Ethernet" on page 50
PROFIBUS	X30 connection point See chapter "PB - PROFIBUS" on page 46
CANopen	X61 connection point See chapter "CN - CANopen" on page 52

Tab. 7-18: Master communications

Installation

PB - PROFIBUS

Description

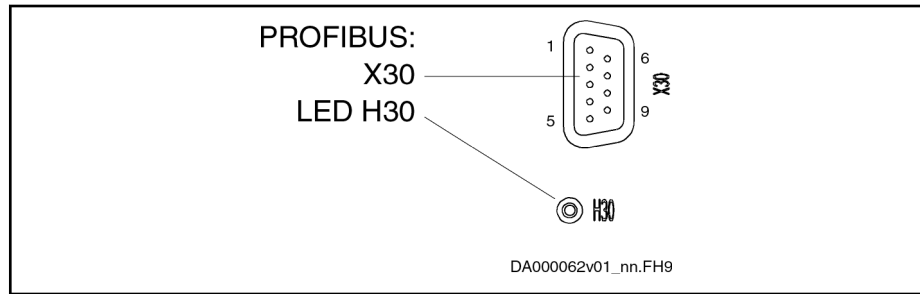

Fig. 7-10: PROFIBUS Interface

View	Identification	Function	
<p>DA000054v01_nn.FH9</p>	X30	PROFIBUS PB	
D-Sub, 9-pin, female	Unit	Min.	Max.
Connection cable Stranded wire	mm ²	0.08	0.5

Tab. 7-19: Function, pin assignment, properties

Pin assignment

Pin	DIR	Signal	Function
1		-	n. c.
2		-	n. c.
3	I/O	RS485+	Receive/transmit data-positive
4	O	CNTR-P	Repeater control signal
5		0 V	0 V
6	O	+5 V	Repeater supply
7		-	n. c.
8	I/O	RS485-	Receive/transmit data-negative
9		0V	0 V

Tab. 7-20: Signal assignment

Shield connection

Via D-Sub mounting screws and metallized connector housing.

Compatibility of the interface

According to DIN EN 50 170

Recommended cable type

According to DIN EN 50 170 - 2, cable type A

Signal specification

Signal	Specification
+5V Repeater supply	+5 V ($\pm 10\%$) Max. 75 mA
Repeater control signal	TTL-compatible: <ul style="list-style-type: none"> • 1: Transmit • 0: Receive Output resistance: 350R $V_{OL} \leq 0.8 \text{ V}$ at $I_{OL} \leq 2 \text{ mA}$ $V_{OH} \geq 3.5 \text{ V}$ at $I_{OH} \leq 1 \text{ mA}$
Receive/transmit data	EIA-RS485 standard

Tab. 7-21: Signal specification

NOTICE	Danger of destroying output "+5V repeater supply" by overload!
Do not short-circuit the output. Do not exceed the maximum current.	

Bus connectors

The PROFIBUS connectors each have a connectable terminating resistor. The terminating resistor must always be active at both the first and last bus node. Carry out the connection as shown in the figures below.

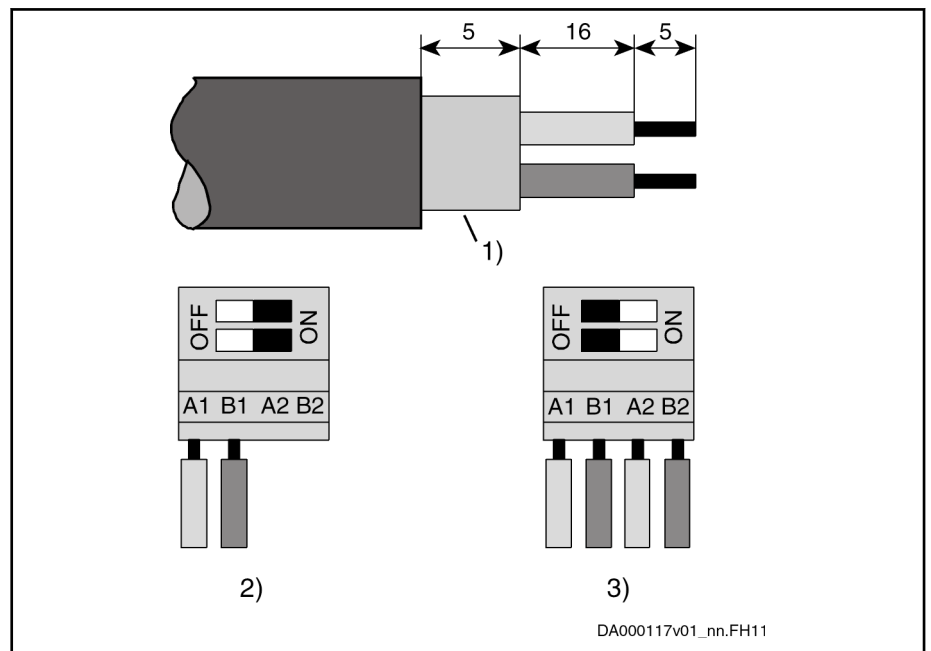

- 1) Shield
- 2) Bus connection and switch position for first node and last node
- 3) Bus connection and switch position for all other nodes

Fig. 7-11: Preparing a cable for connecting a bus connector

To assemble the bus cable, proceed as follows:

- Use cable according to DIN EN50170 / 2 edition 1996
- Strip cable (see figure above)
- Insert both cores into screw terminal block

Installation



Do not interchange the cores for A and B.

- Press cable sheath between both clamps
- Screw on both cores in screw terminals

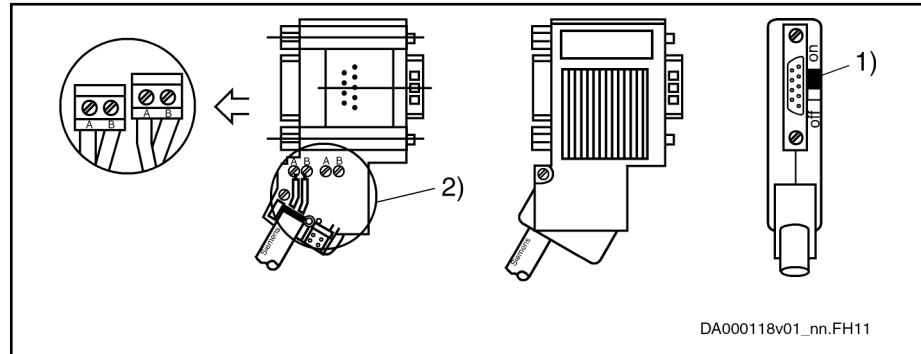

- 1) Switch position for first slave and last slave in PROFIBUS-DP
- 2) Cable shield must have direct contact to metal

Fig. 7-12: Bus connection for first and last slave, bus connector with 9-pin D-sub female connector, INS0541

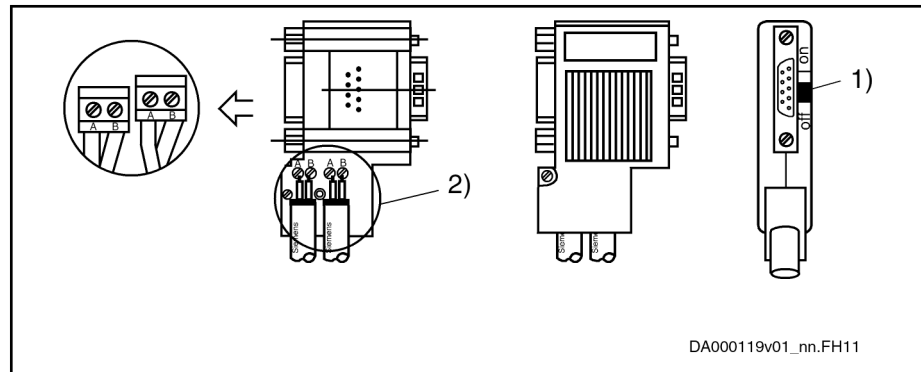

- 1) Terminating resistor is off
- 2) Cable shield must have direct contact to metal

Fig. 7-13: Bus connection for all other slaves, bus connector with 9-pin D-sub female connector, INS0541

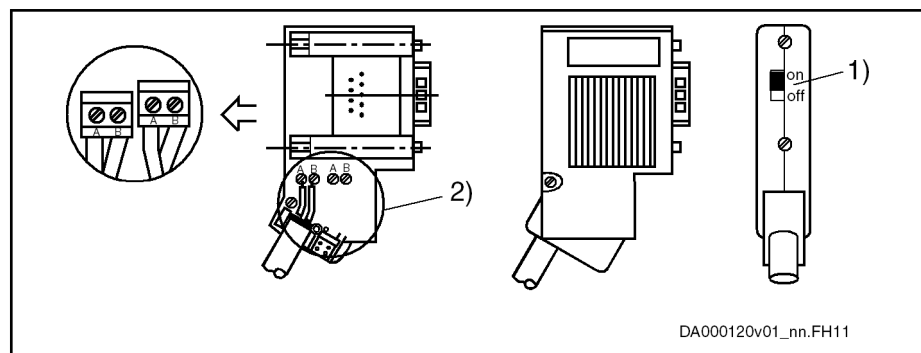

- 1) Switch position for first slave and last slave in PROFIBUS-DP
- 2) Cable shield must have direct contact to metal

Fig. 7-14: Bus connection for first and last slave, without 9-pin D-sub female connector, INS0540

Installation

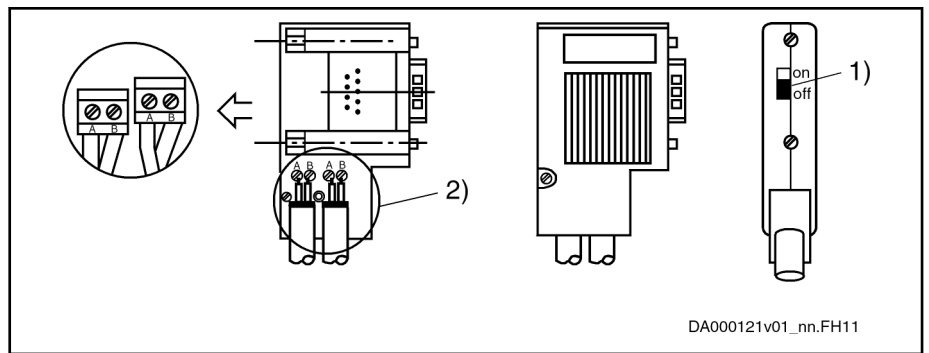

- 1) Terminating resistor is off
- 2) Cable shield must have direct contact to metal

Fig. 7-15: Bus connection for all other slaves, without 9-pin D-sub female connector, INS0540

Connect the drive controller to a control unit using a shielded two-wire line in accordance with DIN 19245/Part 1.

Diagnostic displays For the significance of the diagnostic displays, see firmware documentation.

Installation

ET - Multi-Ethernet

Description Multi-Ethernet (ET)

With the Multi-Ethernet communication module "ET", drive controllers can be integrated in different Ethernet field bus systems (e.g. sercos III, EtherCAT, EtherNet/IP or PROFINET IO).

The LED display depends on the field bus system

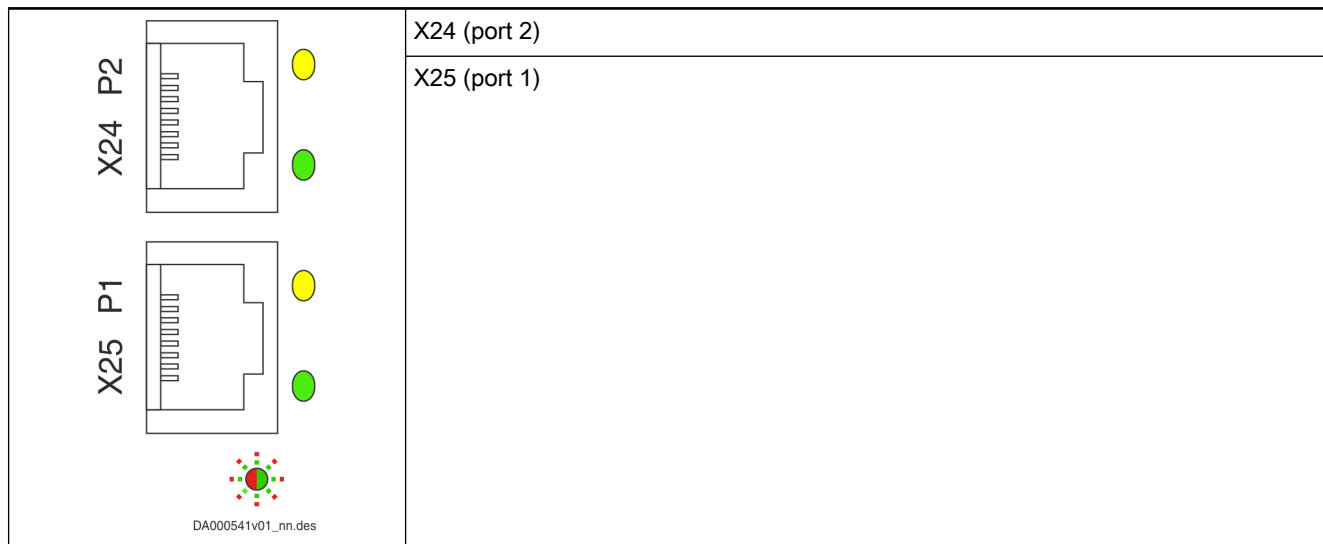

Tab. 7-22: ET, connection point

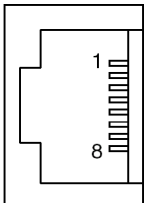
View	Connection	Signal name	Function
 <p style="text-align: center;"><small>DA000041v01_nn.FH</small></p>	1	TD+	Transmit, differential output A
	2	TD-	Transmit, differential output B
	3	RD+	Receive, differential input A
	4	n. c.	-
	5	n. c.	-
	6	RD-	Receive, differential input B
	7	n. c.	-
	8	n. c.	-
	Housing		
Properties			
Standard	<ul style="list-style-type: none"> • Ethernet • Type: RJ-45, 8-pin 		

Compatibility	100Base-TX according to IEEE 802.3u
Recommended cable type	<ul style="list-style-type: none"> • According to CAT5e; type of shield ITP (Industrial Twisted Pair) • Ready-made cables which can be ordered: <ul style="list-style-type: none"> – RKB0011 Long cables (100 m at maximum) to connect the drive system to the higher-level control unit or remote communication nodes. Minimum bending radius: <ul style="list-style-type: none"> – 48.75 mm if laid flexibly – 32.50 mm if laid permanently Order code for a 30 m long cable: RKB0011/030,0 – RKB0013 Short cables to connect devices arranged side by side in the control cabinet. 4 lengths available: 0.19 m; 0.25 m; 0.35 m; 0.55 m Order code for a 0.55 m long cable: RKB0013/00,55 Minimum bending radius: 30.75 mm

Tab. 7-23: Function, Pin Assignment, Properties

Installation

CN - CANopen

Description

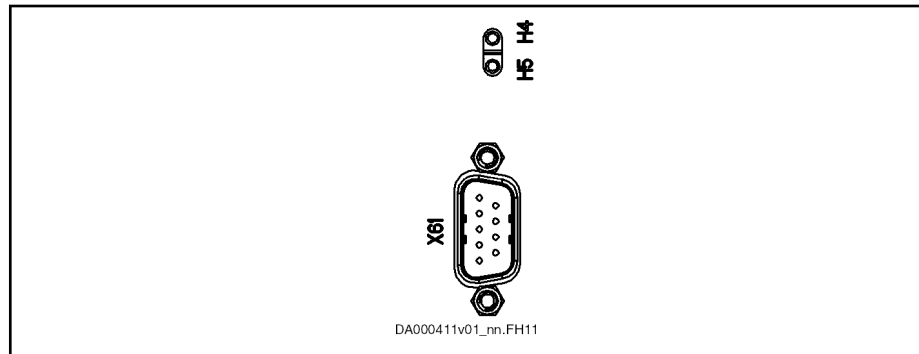

Fig. 7-16: CANopen

Connection point

Conne- ction point	Type	Num- ber of poles	Design	multi-wired [mm ²]	Figure
X61	D-Sub	9	Pin on de- vice	0.25–0.5	

Tab. 7-24: Connection point

Pin Assignment

Pin	Signal	Function
1	n. c.	-
2	CAN-L	Negated CAN signal (Dominant Low)
3	CAN-GND	Reference potential of CAN signals
4	n. c.	-
5	Drain/Shield	Shield connection
6	GND	Reference potential of device
7	CAN-H	Positive CAN signal (Dominant High)
8	n. c.	-
9	n. c.	-

Tab. 7-25: Signal Assignment

7.6 Motor-pump unit

See documentation of the component:

Title	Document type	Material number en (de)
Rexroth Sytronix SvP 70xx Motor-Pump Unit MPA01 ¹⁾	Operating Instructions	R911339824 (R911339822)

1) This documentation contains references to amending documentation for the individual components (motors, pumps, hydraulic fluids, etc.).

Tab. 7-26: Documentation, motor-pump units

8 Commissioning

8.1 System overview

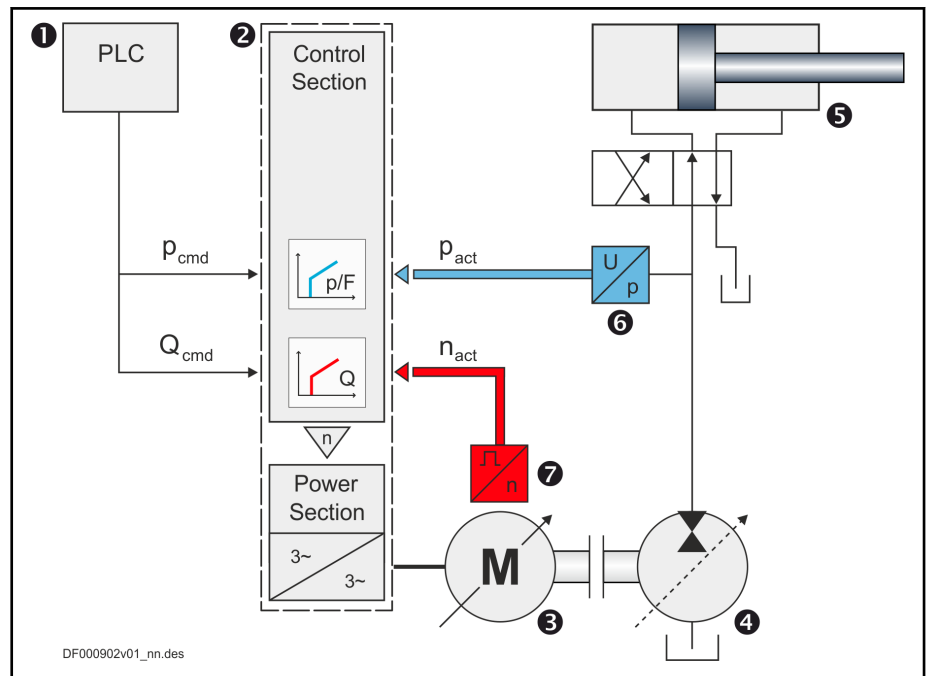

- 1 Control (command values: s_{cmd} = position of the hydraulic cylinder, p_{cmd} = pressure, Q_{cmd} = flow rate)
- 2 Drive controller
- 3 Motor
- 4 Pump
- 3 + 4 Motor-pump unit
- 5 Hydraulic system
- 6 Pressure transducer (p_{act} = actual pressure value)
- 7 Encoder (n_{act} = actual speed value, only relevant for SvP systems)

Fig. 8-1: System overview

Commissioning

8.2 Procedure

8.2.1 Notes

Commissioning a motor-pump unit requires additional components (drive controller, control unit).

Basically, commissioning is carried out in two steps:

1. Commissioning of the **pump drive** (motor control)
2. Commissioning the **pump**

8.2.2 Commissioning the pump drive (motor control)

See documentation of the component:

Title	Document type	Material number en (de)
Rexroth Sytronix SvP 7020 IMC, Variable-Speed Pump Drives	Commissioning Manual	R911376149 (R911376148)

Tab. 8-1: Documentation, motor-pump units

8.2.3 Commissioning the pump

See documentation of the component:

Title	Document type	Material number en (de)
Rexroth Sytronix SvP 70xx Motor-Pump Unit MPA01 ¹⁾	Operating Instructions	R911339824 (R911339822)

- 1) This documentation contains references to amending documentation for the individual components (motors, pumps, hydraulic fluids, etc.).

Tab. 8-2: Documentation, motor-pump units

9 Operation

9.1 Injection molding control IMC

The SvP system operates a PGH internal gear pump. The pumped flow rate results directly from the motor speed.

The used pumps are especially optimized for variable speed operation. The pumps achieve low leakage at a high total efficiency and low noise load. Depending on the application, sensors capture the pressure, cylinder position and motor speed and send the captured values to the drive controller.

The drive controller compares these values to the command values set by the control unit and adjusts the motor speed according to the system requirements.

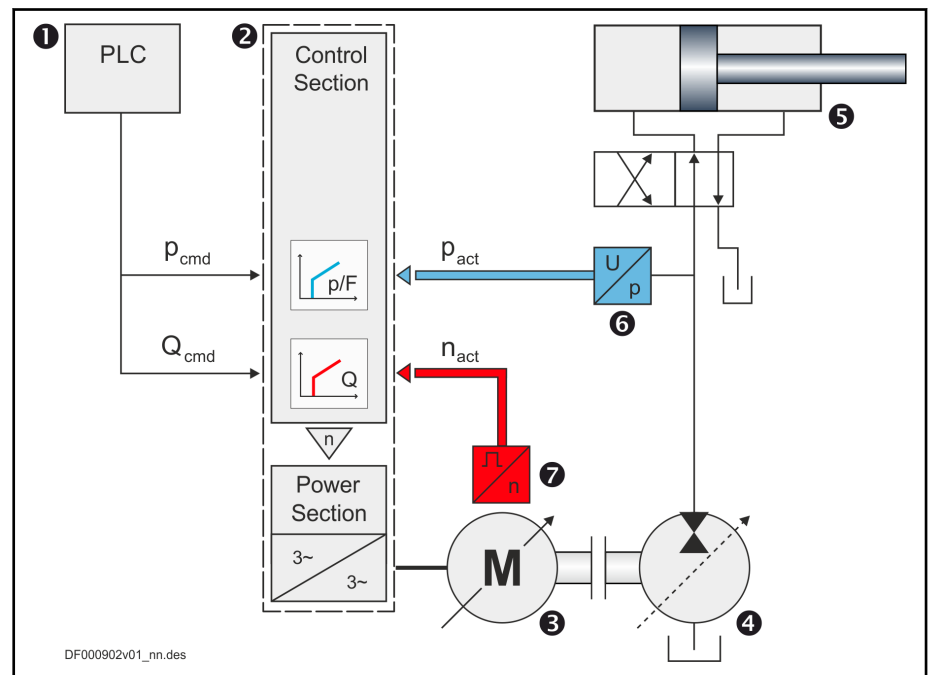

- 1 Control (command values: p_{cmd} = pressure, Q_{cmd} = flow rate)
- 2 Drive controller (control section, power section)
- 3 Motor
- 4 Pump
- 3 + 4 Motor-pump unit
- 5 Hydraulic system
- 6 Pressure transducer (p_{act} = actual pressure value)
- 7 Encoder (n_{act} = actual speed value)

Fig. 9-1: System overview

p/Q-control "p/Q-control" means "injection molding control" (p: pressure, Q: flow rate).

Operation

9.2 Operation modes

See documentation of the component (chapter "IMC commissioning", subchapter "IMC controller – parameter setting" and subchapter "Extended settings"):

Title	Document type	Material number en (de)
Rexroth Sytronix SvP 7020 IMC, Variable-Speed Pump Drives	Commissioning Manual	R911376149 (R911376148)

Tab. 9-1: Documentation

10 Servicing

10.1 System overview

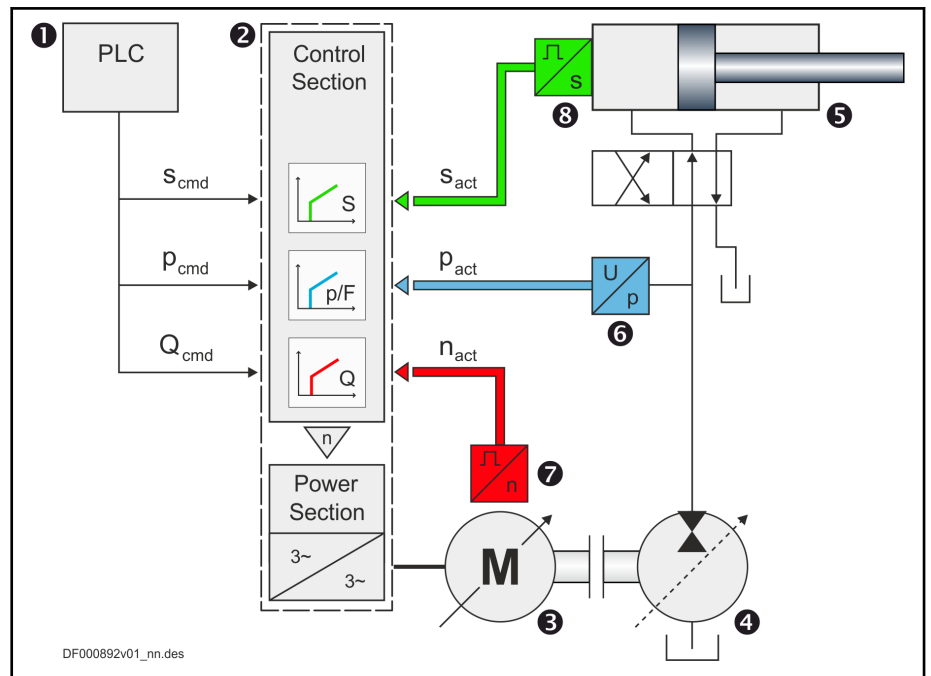

- 1 Control (command values: s_{cmd} = position of the hydraulic cylinder, p_{cmd} = pressure, Q_{cmd} = flow rate)
- 2 Drive controller (control section, power section)
- 3 Motor
- 4 Pump
- 3 + 4 Motor-pump unit
- 5 Hydraulic system
- 6 Pressure transducer (p_{act} = actual pressure value)
- 7 Encoder (n_{act} = actual speed value, only relevant for SvP systems)
- 8 Position measurement (s_{act} = actual position value, only relevant for SvP systems)

Fig. 10-1: System overview

10.2 Drive controllers

Regularly check the filters at the air inlets of the control cabinet. Replace or clean dirty filters.

The electrical components themselves do not require maintenance.

Servicing

10.3 Motor-pump unit

See documentation of the component:

Title	Document type	Material number en (de)
Rexroth Sytronix SvP 70xx Motor-Pump Unit MPA01 ¹⁾	Operating Instructions	R911339824 (R911339822)

1) This documentation contains references to amending documentation for the individual components (motors, pumps, hydraulic fluids, etc.).

Tab. 10-1: Documentation, motor-pump units

11 Decommissioning

Decommission the entire machine as described in the respective operating instructions.

To do so, complete the following steps:

- Note the instructions regarding the entire system.
- Use the machine-side control commands to bring the drive to a controlled standstill.
- Switch off the power voltage and control voltage of the controller.
- Switch off the motor circuit breaker for the fan unit.
- Depressurize the pressure side (P line).
- Switch off the main switch of the machine.
- Secure the machine against restarting.

12 Replacing components

12.1 Disassembly

12.1.1 Preparing disassembly

Decommission the entire system as described in the chapter "Decommissioning".

- Work on machines is only allowed if they are secured and while they are not running.
- Before working, secure the machine against accidental movements and against unauthorized operation.
- Before beginning to work, allow the system to cool down.
- Do not work on hot surfaces.

12.1.2 Disassembly

1. Before you start working, ensure that the system is depressurized.
2. Wait until the discharge time of the electric components has expired (discharge time: refer to the warning at the components, Rexroth IndraDrive: discharge time = 30 minutes).
3. Disconnect all electrical connections.
4. Shut off the suction port of the motor-pump unit. In doing so, observe the instructions regarding the entire system.
5. Secure the system components and supply lines against falling or movements, before unfastening the mechanical connections.
6. Disconnect the piping on the pressure side.
7. If any residual oil escapes, catch it immediately using a suitable container, e.g. an oil tray.
8. Disassemble the system component as described in the documentation of the component:
 - [chapter 12.2 "Motor-pump unit" on page 64](#)
 - [chapter 12.3.1 "HCS01, HCS02, HCS03, HMS01" on page 64](#)

Replacing components

12.2 Motor-pump unit

The instructions for a motor-pump unit describe both disassembling and replacing the motor as well as the pump.

See documentation of the component:

Title	Document type	Material number en (de)
Rexroth Sytronix SvP 70xx Motor-Pump Unit MPA01 ¹⁾	Operating Instructions	R911339824 (R911339822)

1) This documentation contains references to amending documentation for the individual components (motors, pumps, hydraulic fluids, etc.).

Tab. 12-1: Documentation, motor-pump units

12.3 Drive controller

12.3.1 HCS01, HCS02, HCS03, HMS01

See documentation of the component (chapter: "Handling, diagnostic and service functions", subchapter "Replacing the controller"):

Title	Kind of documentation	Material number en (de)
Rexroth IndraDrive ... MPx-20 Functions	Application Manual	R911345608 (R911345607)

Tab. 12-2: Documentation – Firmware

13 Environmental protection and disposal

13.1 Environmental protection

Production processes	The products are made with energy- and resource-optimized production processes which allow re-using and recycling the resulting waste. We regularly try to replace pollutant-loaded raw materials and supplies by more environment-friendly alternatives.														
No release of hazardous substances	Our products do not contain any hazardous substances which may be released in the case of appropriate use. Normally, our products will not have any negative influences on the environment.														
Significant components	Basically, our products contain the following components: <table><tr><td>Electronic devices</td><td>Motors</td></tr><tr><td>• steel</td><td>• steel</td></tr><tr><td>• aluminum</td><td>• aluminum</td></tr><tr><td>• copper</td><td>• copper</td></tr><tr><td>• synthetic materials</td><td>• brass</td></tr><tr><td>• electronic components and modules</td><td>• magnetic materials</td></tr><tr><td></td><td>• electronic components and modules</td></tr></table>	Electronic devices	Motors	• steel	• steel	• aluminum	• aluminum	• copper	• copper	• synthetic materials	• brass	• electronic components and modules	• magnetic materials		• electronic components and modules
Electronic devices	Motors														
• steel	• steel														
• aluminum	• aluminum														
• copper	• copper														
• synthetic materials	• brass														
• electronic components and modules	• magnetic materials														
	• electronic components and modules														

13.2 Disposal

Return of products	Our products can be returned to our premises free of charge for disposal. It is a precondition, however, that the products are free of oil, grease or other dirt. Furthermore, the products returned for disposal must not contain any undue foreign material or foreign components. Send the products "free domicile" to the following address: <p style="text-align: center;">Bosch Rexroth AG Electric Drives and Controls Buergermeister-Dr.-Nebel-Strasse 2 97816 Lohr am Main, Germany</p>
Packaging	The packaging materials consist of cardboard, wood and polystyrene. These materials can be recycled anywhere without any problem. For ecological reasons, please refrain from returning the empty packages to us.
Batteries and accumulators	Batteries and accumulators can be labeled with this symbol.  The symbol indicating "separate collection" for all batteries and accumulators is the crossed-out wheeled bin. The end user within the EU is legally obligated to return used batteries. Outside the validity of the EU Directive 2006/66/EC keep the stipulated directives. Used batteries can contain hazardous substances, which can harm the environment or the people's health when they are improperly stored or disposed of. After use, the batteries or accumulators contained in Rexroth products have to be properly disposed of according to the country-specific collection.
Recycling	Most of the products can be recycled due to their high content of metal. In order to recycle the metal in the best possible way, the products must be disassembled into individual modules.

Environmental protection and disposal

Metals contained in electric and electronic modules can also be recycled by means of special separation processes.

Products made of plastics can contain flame retardants. These plastic parts are labeled according to EN ISO 1043. They have to be recycled separately or disposed of according to the valid legal requirements.

14 Troubleshooting

14.1 How to proceed for troubleshooting

- Always act systematically and targeted, even under pressure of time. Random and imprudent disassembly and readjustment of settings might result in an inability to determine the original error cause.
- First, get a general idea of how your product works in conjunction with the entire system.
- Try to find out whether the product has worked properly in conjunction with the entire system before the errors occurred first.
- Try to determine any changes of the entire system in which the product is integrated:
 - Were there any changes to the product's operating conditions or operating range?
 - Were there any changes or repair works on the entire system (machine, electrics, control) or on the product? If yes: Which?
 - Was the product or machine used as intended?
 - How did the malfunction appear?
- Try to get a clear idea of the error cause. Directly ask the (machine) operator, if required.
- Document the error condition and compare it to the initial condition. If you cannot repair the error, please contact one of the contacts at www.boschrexroth.com.

14.2 Diagnostic concept

See documentation of components (chapter "Parameters, diagnostics, service", subchapter "Error messages and warnings for injection molding control (IMC)" and subchapter "Troubleshooting guide"):

Title	Document type	Material number en (de)
Rexroth Sytronix SvP 7020 IMC, Variable-Speed Pump Drives	Commissioning Manual	R911376149 (R911376148)

Tab. 14-1: Documentation

Index

0 ... 9

24V, 0V..... 34, 36

A

Accumulators..... 65
 Appropriate use..... 9
 Applications..... 9
 Assembly..... 27

B

Batteries..... 65

C

Cables
 RKB0011..... 51
 RKB0013..... 51

CANopen

 Connection point X61..... 52

CN

 CANopen..... 52

Commissioning..... 55

Communication module

 CANopen - CN..... 52
 Multi-Ethernet - ET..... 50
 PROFIBUS - PB..... 46

Connection diagram

 CSB02.1A-xx, System function IMC..... 41
 CSx02.1B + option DA, system function
 IMC..... 42
 CSx02.1B, IMC system function..... 43
 HCS01, control section with master com-
 munication, IMC system function..... 38
 HCS01, control section without master
 communication, with DA option, IMC sys-
 tem function..... 39
 HCS01, power section..... 29
 HCS02, power section..... 31
 HCS03, power section..... 33
 HMS01, power section..... 35

Connection points

 CSB02/CSH02 control section..... 44
 HCS01, control section..... 40
 HCS01, power section..... 30
 HCS02, power section..... 32
 HCS03, power section..... 34
 HMS01, power section..... 36
 Master communication..... 45

Contained substances

 see "Significant components"..... 65

Control section

 Connection diagram, HCS01 with master
 communication, IMC system function..... 38
 Connection diagram, HCS01 without
 master communication, with DA option,
 IMC system function..... 39

 CSB02/CSH02, Connection diagram..... 41
 CSB02/CSH02, connection points..... 44
 HCS01, connection points..... 40

D

Decommissioning..... 61
 Diagnostics
 Concept..... 67
 Disassembly..... 63
 Disposal..... 65
 Documentation
 Amending documentations..... 5
 Validity..... 5
 Drive system..... 11

E

Electric drive system..... 11
 Environmental protection..... 65
 ET
 Optional module, Multi-Ethernet..... 50
 Ethernet
 Multi-Ethernet, Optional module..... 50

H

Hazardous substances..... 65
 HM20-2X
 Pressure transducer, Assembly..... 28

I

IMC
 Connection diagram, CSB02.1A with
 master communication..... 41
 Connection diagram, CSx02 with master
 communication, without DA option..... 43
 Connection diagram, CSx02.1B without
 master communication, with option DA..... 42
 Connection diagram, HCS01 with master
 communication..... 38
 Connection diagram, HCS01 without
 master communication, with DA option..... 39
 Device configuration..... 23
 Injection molding control..... 57
 System function..... 22
 Inappropriate use..... 10
 Consequences, exclusion of liability..... 9
 Injection molding control IMC..... 57
 Installation..... 29

L

L+, L-..... 32, 34, 36

M

Malfunctions..... 67
 Master communication

Index	
Connection points.....	45
O	
Operation.....	57
Optional module	
CN, CANopen.....	52
ET.....	50
PB.....	46
P	
p/Q-control.....	57
Packaging.....	65
PB	
Optional module.....	46
PELV.....	15
Pressure transducer HM20-2X	
Assembly.....	28
Production processes.....	65
PROFIBUS	
Optional module.....	46
Protective extra-low voltage.....	15
R	
Recycling.....	65
Replacing components.....	63
Return of products.....	65
RKB0011.....	51
RKB0013.....	51
S	
Safety instructions for electric drives and controls.....	11
Servicing.....	59
Significant components.....	65
State-of-the-art.....	9
Storage.....	25
SvP 7020	
Operation modes.....	58
Overview of components.....	22
System function	
IMC.....	22
Sytronix	
SvP 7020.....	22
T	
Transport.....	25
Troubleshooting.....	67
U	
Use	
Appropriate use.....	9
Inappropriate use.....	10
X	
X3.....	30, 32, 34
X4.....	40
X5.....	30, 32, 34, 36
X6.....	30, 32, 34, 36
X9.....	30, 32, 34
X13.....	30, 32, 40
X22 P2, X23 P1.....	40
X24 P2, X25 P1.....	40
X30.....	40
X31.....	40
X32.....	40
X47.....	40
X61.....	40
CANopen.....	52

Notes

Notes

Notes

Bosch Rexroth AG

Electric Drives and Controls

P.O. Box 13 57

97803 Lohr, Germany

Bgm.-Dr.-Nebel-Str. 2

97816 Lohr, Germany

Phone +49 9352 18 0

Fax +49 9352 18 8400

www.boschrexroth.com/electrics



R911377189