



OIL SOLUTIONS

PO Box 38
Strathfieldsaye, VIC, 3551
1800 OIL SOL
1800 645 765
sales@oilsolutions.com.au
www.oilsolutions.com.au
"For All Your Hydraulic Needs"



**CONTINENTAL
HYDRAULICS**
engineering in motion

HYDRECO

ADVANCED HYDRAULIC TECHNOLOGIES

INDUSTRIAL & MOBILE SOLUTIONS



We're in this together.

Welcome to a changing Continental

As the world of Fluid Power evolves, so do we, at an increasingly faster pace. From hydraulics to motion and mobile solutions, from the mid-west to the world, from analog control logics to computerized electronics, we are riding the wave of technology in our fast changing markets.

Continental, an established part of the Duplomatic Motions Solutions Group, has been at the forefront of power transmission innovation for over 60 years and again is a leading force in transforming the industrial world we live in.

Facing global consolidation of manufacturers of fluid power and automation into a few "gigantic" and often irresponsible multinationals, most customers have been left-essentially-with two choices. Either put themselves entirely into the hands of these larger suppliers, or finally rediscover the lively world of small-to-medium size companies like Continental Hydraulics out there.

This is the new opportunity for global growth, the future of Industrial and Mobile Motion Solutions and Power Transmission.

Let's work together.



RAFFA INVREA
General Manager

INDUSTRIAL & MOBILE SOLUTIONS

Our Four Pillars

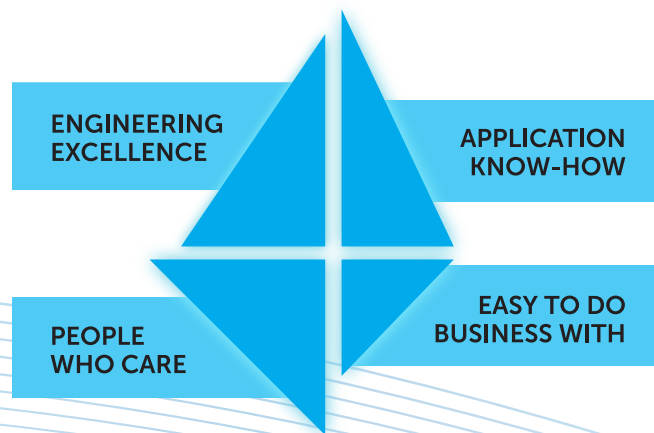

Our Four Pillars guide us in our day-to-day business to ensure we are delivering value to our customers



1800-OILSOL
1800-645765

<https://oilsolutions.com.au/>

sales@oilsolutions.com.au



New 2020 Products

Power Black Piston Pump (HPVR)

- Enhanced pressure rating to 4000PSI
- Increased Interchangeability
- Robust trunnion bearing design
- Flow rates up to 30 GPM

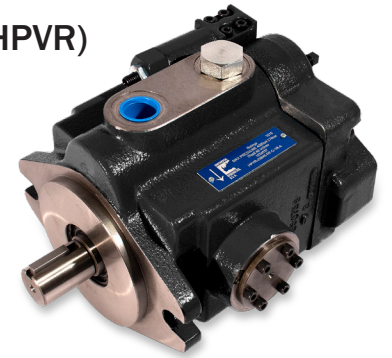

IO-Link - Industrial 4.0 has a new partner

- Easy integration
- Remote configuration
- Diagnostic functions
- Point to point communication



Joysticks - Electrical

- Modern Hall Sensor technology
- User friendly setup
- Built for demanding environments
- Multiple output Analog, PWM, Can-Bus, Rationmetric



Electric Actuators

- Customizable solutions
- Cylinders can be equipped with in-line or parallel motors
- Different types of screws for motion transmission
- Up to 22 tons of force and speeds to 50 inch per second

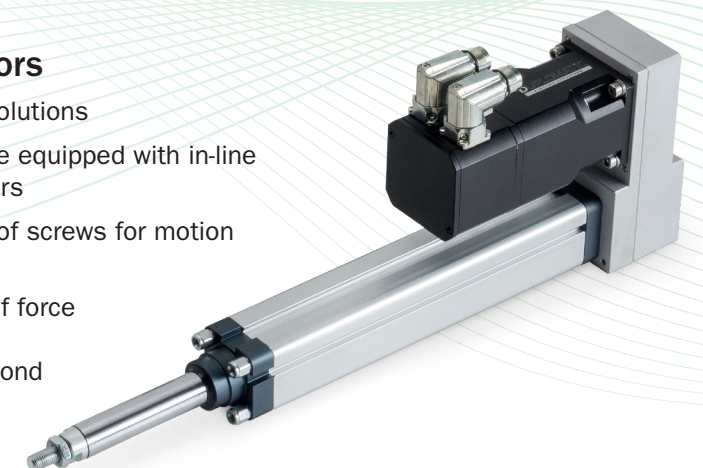

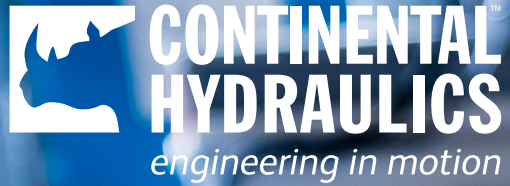

**CONTINENTAL HYDRAULICS
SERVES MANY INDUSTRIES
AND APPLICATIONS**

Capabilities

Continental Hydraulics Inc. manufactures a wide range of directional valves, pressure controls, modular stack valves, servo-proportional valves, proportional pressure control valves, hazardous location / explosion proof valves, position monitored valves, variable vane pumps, variable piston pumps and hydraulic power units. Our power unit division will design and build systems with flow rates up to 500 GPM, tank size up to 1000 gallon, and pressure up to 5000 PSI.

Quality

Quality Management System, which complies with the ISO 9001:2015 Standard, (Certification February 27, 2019 to April 3, 2022) is aimed at:



**ISO 9001:2015
CERTIFIED**

- Promoting a vision of quality in each function of our organization and challenging the whole team to always strive for standards above those of our competitors;
- Maintaining a talented and productive work force that determines our reputation and vitality;
- Ensuring that innovation and improvement are at the forefront of our business by constantly challenging ourselves to exceed our customers' expectations;
- Monitoring our customers' satisfaction level through the analysis of claims and by performing thorough evaluations of products not meeting customer requirements.

Industrial Solutions for:



Food and Beverage



Machinery Manufacturing



Forestry and Woodworking



Transportation Equipment Manufacturing



Oil and Gas



Energy

Piston Pumps

NEW

**POWER
BLACK**

HPVR and LPV

Our variable volume, pressure compensated axial piston pumps continuously match output flow to the system demands.

They're designed to closely match the Eaton-Vickers PVB and PVQ and the Denison PV series of pumps in physical size, port location for ease of interchange and replacement.



HPVR

Key Features:

- Increased Pressures to 4000 PSI
- Flow rates to 30 GPM
- Replaceable port plate, piston show wear plate and control piston wear plate to simplify maintenance
- Tandem pump options
- Interchangeability
- Multiple control options
- New Trunnion bearing and heavy duty components provide long life and reduced noise

LPV

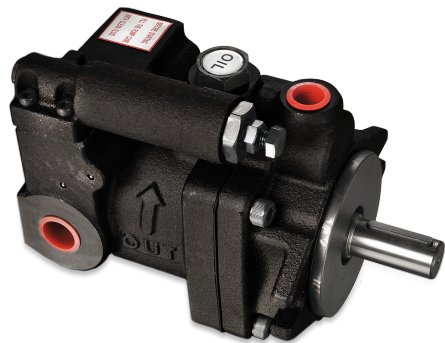

Vane Pumps

PVX and PVR

Our variable volume, pressure compensated design makes them an excellent choice for many industrial applications.

These field-proven, highly durable pumps provide long life and quiet operation resulting from the use of heavy duty forged, one-piece rotors and hydrodynamic bearings and pressure balance side plates



PVX

Key Features:

- Flow rates to 75 GPM on single pumps
- Pressures to 3000 PSI
- Low noise (to 67dBA at 3000PSI)
- Contamination and lubricity tolerant
- Multiple control options
- Great suction characteristics
- Great for applications with high speed proportional products

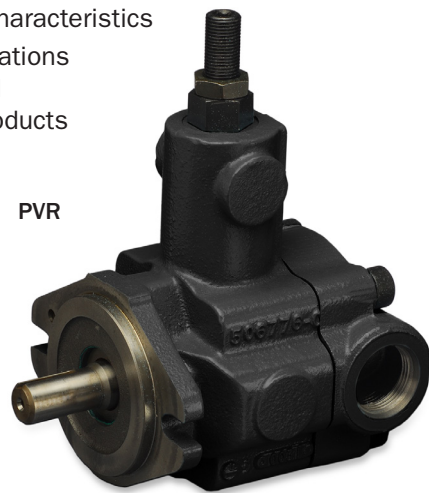

PVR

IO LINK Valves

NEW

Easy integration and diagnostic functions
IO-LINK solutions have the same connection for every type of valve; replace the traditional wiring of both on-off valves and proportional valves

Enable diagnostics and setting adjustments, as required by Industry 4.0. Advantages ranging from predictive maintenance to performance measurements for productivity.



Key Features:

IO-LINK solutions have the same connection for every type of valve; it replaces the traditional wiring of both On-Off and Proportional valves with 5 pin connectors. IO-LINK valves enable diagnostics and setting adjustments, as required by Industry 4.0.

- IO-LINK is not to be considered as a new communication fieldbus; it is an efficient complement, that can connect the PLC digital output directly to the hydraulic valve
- IO-LINK is a point to point connection between the main or the remote PLC or the IO power strip and any type of hydraulic valve
- The IO-LINK wire connection can be a simple unshielded cable
- IO-LINK allows the use of different supplies for logic and power
- IO-LINK is a full digital connection

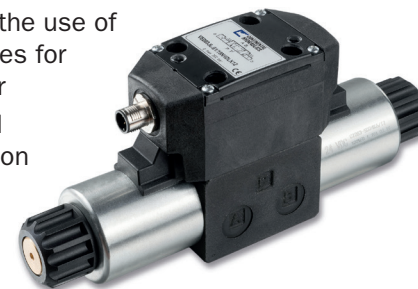

Directional Control Valves

Rugged, durable and efficient

High flows and low pressure drops make them the perfect choice for new systems or to improve older ones.

Solenoid Operated

Available in a variety of coil connections or top electrical box that offer multiple connection styles. With pressures to 5000 PSI and flow rates to 290 GPM, these NFPA and ANSI/ISO standard mounting pattern valves are available in six configurations.

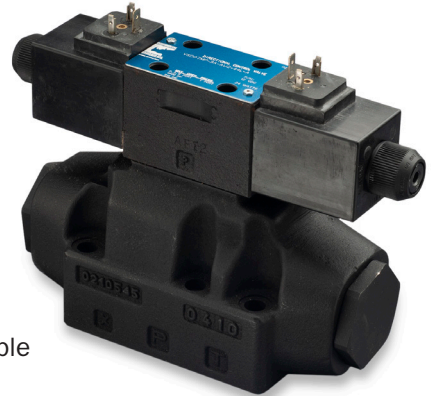

Hazardous Location Products

Special provisions used in the solenoids, allow these products to meet the following area classifications: ATEX EX d IIC, CSA, CE

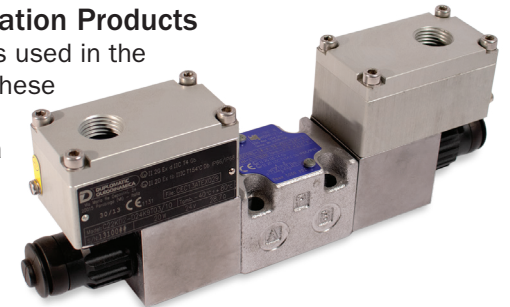

Monitored

This version offers the system designer the ability to not only operate the circuit, but also receive a validation signals to help meet safety compliance requirements.



Mechanical, Air, Hydraulic Operated

Additional operators to help meet a variety of operator interface requirements.

Operator interfaces include choices of Air, Hydraulic, Levers and Cams.



Modular Stack Valves

Flow, check and pressure controls

Reduced plumbing, leak points and space requirements.

Aluminum body products rated up to 3000 PSI



Cast Iron body products rated up to 5000 PSI



Sub-plate mounted pressure controls

- R06 to R10 Sub-plate mounting for flow and pressure to 132 GPM (500 LPM)/5000 PSI (345 Bar)

- In-line Threading ports models



Key Features:

- Blocking valves
- D03/D05 (NG6/NG10) mounting sizes
- Pressure relief and reducing functions
- Load holding – check valves and counter-balance
- Pressure compensator's

Proportional Valves

High Speed precision with digital electronics

Five styles of proportional valves in multiple mounting configurations for design flexibility.

Digital integrated electronics and LVDT position transducer or robust valves with remote mounted electronics for open and closed loop control over your motion requirements.

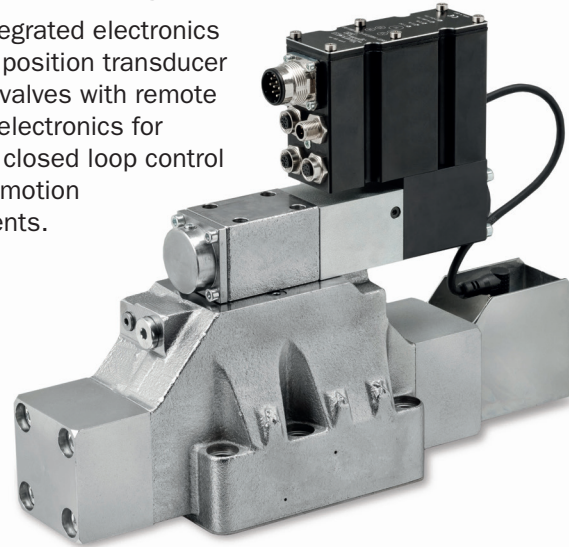

Electronics: Open and closed loop control modules

Large selection of motion controls



Key Features:

- Variety of control interface options: Analog Voltage or Current / IO Link Ethernet IP / EtherCAT / Profinet / PROFIBUS DP / CAN Open / Powerlink
- GUI program to assist in troubleshooting and parametrization
- Control over position, force and speed of actuators
- Step response times as low as 8ms.
- Hazardous Location – Explosion Proof.

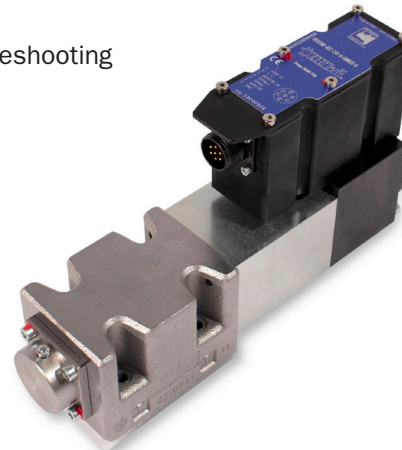

Power Units

Standard and Custom units

Built for light duty and heavy, continuous duty for today's harshest environments. For fast, easy, setups, all power unites are shipped 100% tested. Tank capacity from 1 to over 5000 gallons in steel, stainless steel or aluminum.

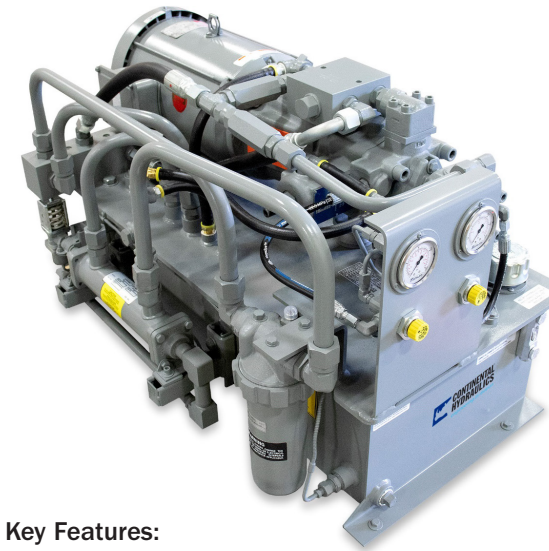

Key Features:

- System flow up to 500 GPM, and pressure to 5000 PSI
- Test up to and beyond 200 HP including international voltages
- Fluids and compatible seals, water glycol, phosphate ester, mineral, ATF, and more
- Motor starters with system accessories.
- Drawings in SolidWorks format or AutoCAD DWG/DFX.
- 18 months warranty on the power unit, 36 months on the Continental Hydraulic components.

Applications:

- Sleeve bearing lubrication, cement plants, refineries, and power plants.
- Sand cast mold and match plate machine
- Water treatment plant - basin scraper
- Utilized to control a multi-axis missile guidance system testing fixture
- Automotive high speed cut-off application on rolling mills
- Solar energy panel control and hydroelectric dam valve control

NFPA/JIC

Created for heavier duty, continuous-use industrial applications requiring design flexibility and rugged construction.

Low Profile

Option suited for applications with moderate fluid volume and flow rate. Solution where space is premium, or power of a NFPA/JIC-Style unit is needed in a smaller, less expensive package.

Little Champ

Designed for where space is limited. They're ideal for applications requiring moderate fluid volume and flow rate, short hydraulic lines, and quick cycling. Little Champ power units can be built at your facility at your convenience. Continental will supply the complete set of components and hardware.

L Shape

Ideal for high fluid volume and flow rate applications. Removable tank cover simplifies cleaning. Feature flooded suction inlets that eliminate the need for the pump to lift hydraulic fluid, reducing wear and tear.

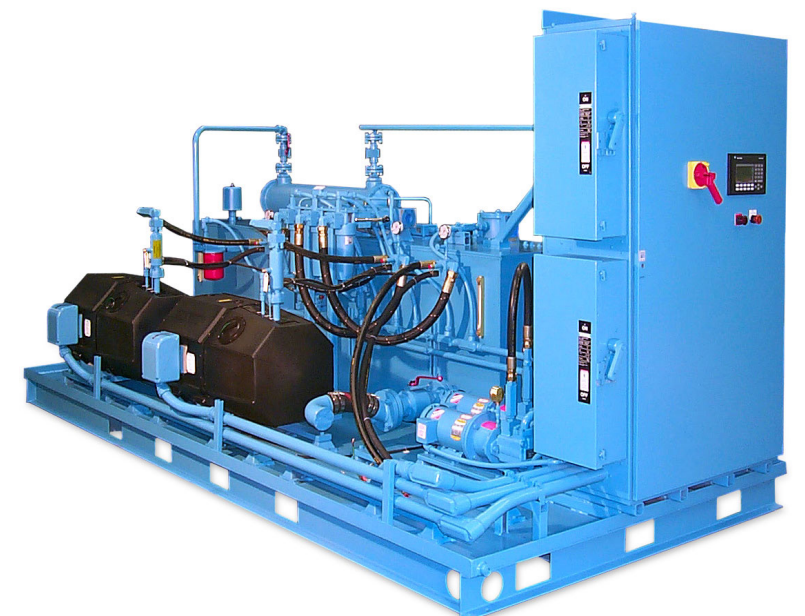

HYDRECO
ADVANCED HYDRAULIC TECHNOLOGIES

**HYDRECO IS THE
MOBILE COUNTERPART OF
CONTINENTAL HYDRAULICS**

The family is growing

Continental Hydraulics and Hydreco are the driving force for industrial and mobile applications across North America. Our combined and dynamic offering provides our partners with the confidence to specify to the highest standards.

A natural evolution in the growth of Continental has been to develop proven mobile application technology and to partner with a global player - resulting in a new and exciting proposition. Both part of the Duplomatic Motion Solutions Group, are supported by investment into technology innovation and expertise that our customers value.

A global corporation with companies and plants throughout the UK, Australia, Italy, India, etc. and now co-located at Continentals main North American site in Minnesota. Manufacturing and selling a full line of mobile hydraulics starting with their complete offer of gear pumps, of David Brown Hydraulics heritage (inventor of the first gear pumps).

Mobile Solutions for:



Off Road
Construction



On Road
Transportation



Mining



Agriculture,
Forestry, and
Municipal



Marine and
Off-shore



Military and
Defense

Remote Controls



Mobile application, tailored solutions.

Electrical Joysticks (See page 3)

For use in electronic control systems with or without programmable functions: On Off / Proportional / Analogue 0:5V / PWM / CAN-bus.



Pilot Control

Remote pilot operation of directional control valves with low effort controls.

- Single, multiple and joystick controllers
- Stylish, ergonomic designs for modern cabs
- Range of accurate, low hysteresis control curves
- Dedicated pilot valves, with magnetic detentes, to control 2 or 3 spool directional valve for wheeled loader applications
- Range of valves with foot pedal operation

Handles

Ergonomic multi function handles for both safe and accurate man/machine interface.

- Knobs and levers with or without electrical switches and range of buttons
- Multifunction handles with extended button area
- Dedicated safety switch functions; with button or capacitive sensors safeTgrip



Gear Pumps

High durability and high efficiency for modern off-road machinery

Helical gear, spur gear, and worm pumps together with cast iron and aluminum bodies.



Key Features:

- Modern, simple, robust design
- Max 2500 PSI and 4000 RPM (1500 world series)
Max 3000 PSI and 3000 RPM (1900 world series)
Max 3000 PSI and 2500 RPM (2900 world series)
- Very low noise levels
- Range of customer interfaces
- Compatible with environmentally aware fluids
- Flexible build configuration
- Up to 350 bar rated pressure

Bankable Control Valves

Directional Control Valves for mobile, materials handling and other applications.

Helical gear, spur gear, and worm pumps together with cast iron and aluminum bodies.

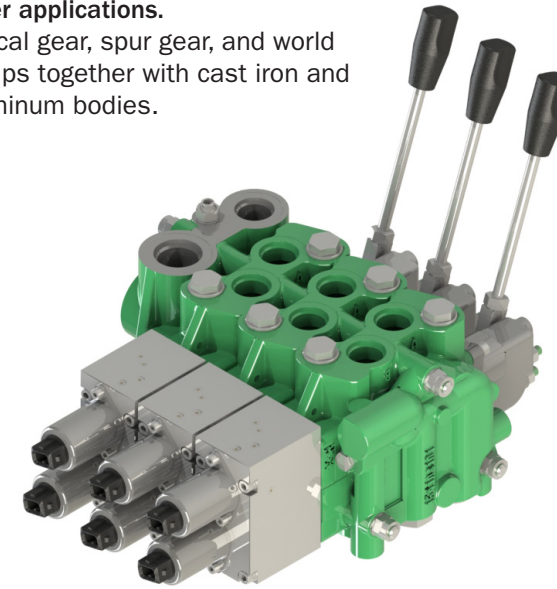

Key Features:

- 30 to 450 l/min (7.9 to 119 gal/min) and up to 250 bar (3500 psi) system pressure
- Parallel, tandem and mixed circuits available depending on model
- Mono-block and sectional high grade iron housings
- Wide range of spool types and metering characteristics
- Operating systems: manual, hydraulic, electro-hydraulic and pneumatic
- Integral system relief valve together with individual port relief and make up options available

Power Take Off's (PTO's)

PTO's and on-road hydraulics with a reputation for rugged design and long life.

Serving the transport hydraulic market in applications such as tipping/dumping, waste management, municipal, cranes, recovery vehicles, mining, drilling and construction.

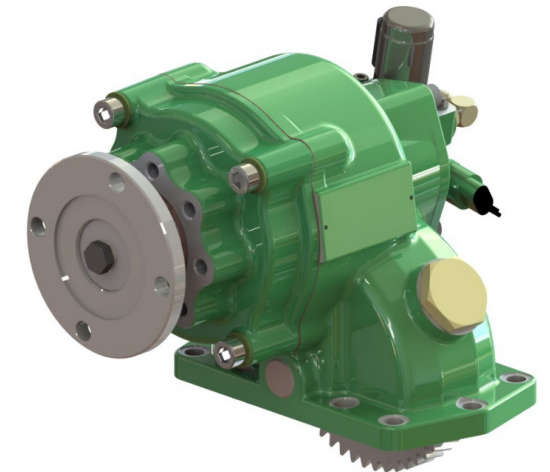

Key Features:

- With a comprehensive range of PTO's for most vehicle transmissions, the Hydreco Powauto solutions will be your partner for any application.
- PTO's with constant and hot shift options catering for all applications across extensive range of US, European and Japanese vehicles.

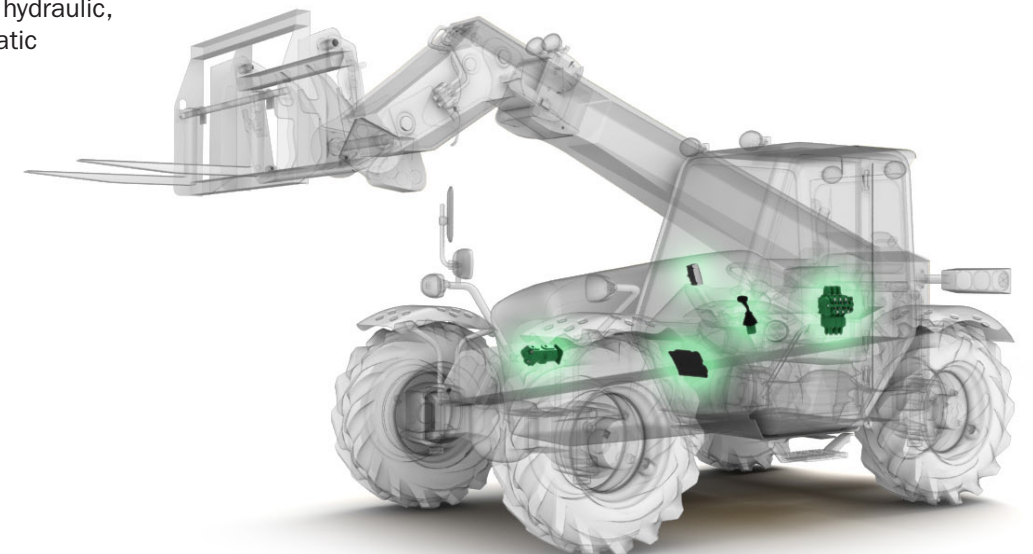

Electric Actuators and Servo's



Repeatability with built in power savings and smart controls at your fingertips

It's not the electrical cylinder that will set limits to your applications; it is rather your application characteristics that will determine the most suitable cylinder for your projects.

Thanks to a complete range of possible combinations of sizes, accessories, type of screws, motors and drives,

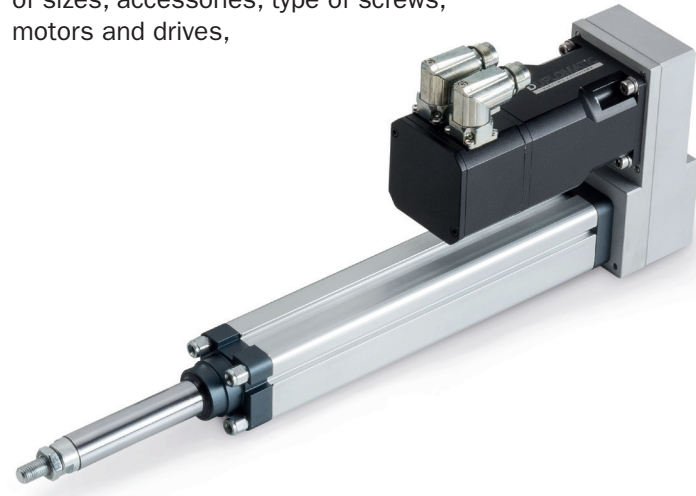

Key Features:

- Customizable solutions
- Cylinders equipped with in-line or parallel motors
- Different types of screws for motion transmission
- Up to 22 tons of force, speeds to 50 inch per sec.
- Variety of drives and motors:
 - Stepper, Brush/Brush-less, DC Motors
 - Torque, speed and positioning control
 - Programmable digital inputs and outputs

Applications:

Industrial and manufacturing

Automotive, Riveting and press fitting, Pressing devices, Cutting blade actuators, Molding, Loading devices, Spot welding, Railway maintenance, Wind turbines, Wood processing

Food, beverage and pharmaceutical

Dosing of liquid products, Pick and place, Slicing machineries, Packaging, Opening/closing doors

Servo Motors

Brush-less motors made to offer a wide range of sizes, rated power, supply voltages and feedbacks. They are robust effective, and suitable for most industrial applications.



Servo Drives to control the motor

- In torque control mode, with analog input $\pm 10V$
- In speed control mode, with analog input $\pm 10V$
- In position control mode: Pulse+, CCW+ CW, A+B phase (5V-24V)

Digital inputs are available to set the drive at the optimum performance for the specific application. As an example, it is possible to enable or reset the drive, select the control mode, switch electronic gear ratio, switch gain, set the homing position, a quick stop, set end-stops, etc. Digital output can be used to monitor axis status.



We are proud members of the **DUPLOMATiC** Group:
MOTION SOLUTIONS



Italy
160 Employees
Valves, Systems,
Actuators



UK, Italy, USA, Australia,
India, Germany, Norway
130 Employees
Mobile: Valves, Pumps,
Cylinders, Joysticks



Italy
30 Employees
Systems



Italy
70 Employees
Cylinders



United States
75 Employees
100+ Distributors
Valves, Pumps,
Power Units



China
10 Employees
Valves





1800-OILSOL
1800-645765

<https://oilsolutions.com.au/>

sales@oilsolutions.com.au

INDUSTRIAL & MOBILE SOLUTIONS

The difference at Continental

At Continental, we have built our reputation on these four pillars that make our company different: People who care, who deliver engineering excellence and application know-how, all while being easy to do business with.

From hydraulics to motion solutions, from the Mid-West to the World, from analogue control logics to computerized electronics and AI, we are riding the wave of technology in our fast-changing markets.

Continental has been at the forefront of power transmission innovation for over 60 years and is – a leading force in transforming the industrial world we live in.



Global Support

As a member of the Diplomatic Group our distribution and service network is quick, reliable, and responsive to our customer's needs. Rest assured that no matter where you're located, we will be there with unrivalled products and technical expertise.



Technical Support

Quality products are only part of Continental and Hydreco's commitment to our customers. We also provide advisory, planning, and design services specifically geared to your application and backed by on-time delivery, full repair and test facility capabilities.



Exceptional People

Continental engages and inspires their workforce to deliver on our four pillars of difference, providing the very best in what we do. Our culture, like everything at Continental, is made possible by each employee's contribution as a unified team.



Industrial Solutions



Mobile Solutions

CONTINENTAL HYDRAULICS INC.

4895 12th Avenue East,
Shakopee, Minnesota 55379
General: 952-895-6400
Fax: 952-895-6444
sales@conthyd.com
www.continentalhydraulics.com

HYDRECO INC.

4895 12th Avenue East,
Shakopee, Minnesota 55379
Cust. Serv: 952-999-9384
Fax: 952-895-6444
sales-us@hydreco.com
www.hydreco.com

CONTINENTAL HYDRAULICS AND HYDRECO ARE PROUD MEMBERS OF THE **DIPLOMATIC** GROUP
MOTION SOLUTIONS