

# Hydraulics Network

CATALOGUE **2026**

GAUGES & TEST COUPLINGS

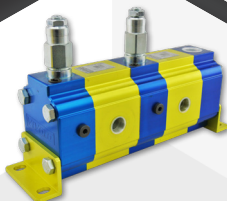
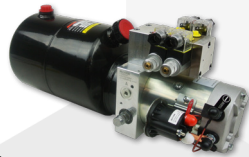

**MiMOTION**

**TECH DATA**
**Pressure Gauge 1.5" Bottom Entry**

Part #	Pressure Range	Thread
121-21-124-V-000J-SK	-76-0 in Hg	1/4" BSPP
121-21-122-V-0Z-SK-1	-1 bar	1/4" BSPP
121-21-122-00010J-SK	0-10 bar	1/4" BSPP
121-21-122-00160J-SK	0-160 bar	1/4" BSPP
121-21-122-00250J-SK	0-250 bar	1/4" BSPP
121-21-122-00315J-SK	0-315 bar	1/4" BSPP

**TECH DATA**
**Pressure Gauge 2.5" Bottom Entry - 1/4" BSPP**

Part #	Pressure Range	Thread
ILX6305RL0/10	0-10 bar	1/4" BSPP
ILX6305RL0/16	0-16 bar	1/4" BSPP
ILX6305RL0/25	0-25 bar	1/4" BSPP
ILX6305RL0/40	0-40 bar	1/4" BSPP
ILX6305RL0/60	0-60 bar	1/4" BSPP
ILX6305RL0/100	0-100 bar	1/4" BSPP
ILX6305RL0/160	0-160 bar	1/4" BSPP
ILX6305RL0/250	0-250 bar	1/4" BSPP
ILX6305RL0/315	0-315 bar	1/4" BSPP
ILX6305RL0/400	0-400 bar	1/4" BSPP
ILX6305RL0/600	0-600 bar	1/4" BSPP
ILX6305RL0/700	0-700 bar	1/4" BSPP

**TECH DATA**
**Digital Pressure Gauge 2.5" Bottom Entry - 1/4" BSPP**

Part #	Pressure Range	Thread
SDI2.5-L-3-4-100	0-100 bar	1/4" BSPP
SDI2.5-L-3-4-400	0-400 bar	1/4" BSPP
SDI2.5-L-3-4-700	0-700 bar	1/4" BSPP

**TECH DATA**
**Pressure Gauge 4.0" Bottom Entry - 1/2" BSPP**

Part #	Pressure Range	Thread
ILX1005RL0/10	0-10 bar	1/2" BSPP
ILX1005RL0/16	0-16 bar	1/2" BSPP
ILX1005RL0/25	0-25 bar	1/2" BSPP
ILX1005RL0/40	0-40 bar	1/2" BSPP
ILX1005RL0/60	0-60 bar	1/2" BSPP
ILX1005RL0/100	0-100 bar	1/2" BSPP
ILX1005RL0/160	0-160 bar	1/2" BSPP
ILX1005RL0/250	0-250 bar	1/2" BSPP
ILX1005RL0/315	0-315 bar	1/2" BSPP
ILX1005RL0/400	0-400 bar	1/2" BSPP
ILX1005RL0/600	0-600 bar	1/2" BSPP
ILX1005RL0/700	0-700 bar	1/2" BSPP

**121**

**ILX6305**

**SDI2.5**

**ILX1005**

**TECH DATA**
**Pressure Gauge 1.5" Rear Entry**

Part #	Pressure Range	Thread
124-21-124-V-000J	-76-0 in Hg	1/4" BSPP
124-21-122-V-0Z-SK-1	-1 bar	1/4" BSPP
124-21-122-00010J-SK	0-10 bar	1/4" BSPP
124-21-122-00160J-SK	0-160 bar	1/4" BSPP
124-21-122-00250J-SK	0-250 bar	1/4" BSPP
124-21-122-00315J-SK	0-315 bar	1/4" BSPP

**TECH DATA**
**Pressure Gauge 2.5" Rear Entry**

Part #	Pressure Range	Thread
ILX6306VPBLO/-1	-1 bar	1/4" BSPP
ILX6306PBLO/10	0-10 bar	1/4" BSPP
ILX6306PBLO/16	0-16 bar	1/4" BSPP
ILX6306PBLO/25	0-25 bar	1/4" BSPP
ILX6306PBLO/40	0-40 bar	1/4" BSPP
ILX6306PBLO/60	0-60 bar	1/4" BSPP
ILX6306PBLO/100	0-100 bar	1/4" BSPP
ILX6306PBLO/160	0-160 bar	1/4" BSPP
ILX6306PBLO/250	0-250 bar	1/4" BSPP
ILX6306PBLO/315	0-315 bar	1/4" BSPP
ILX6306PBLO/400	0-400 bar	1/4" BSPP
ILX6306PBLO/700	0-700 bar	1/4" BSPP

**TECH DATA**
**Pressure Gauge 4.0" Rear Entry**

Part #	Pressure Range	Thread
ILX1008PBLO/10	0-10 bar	1/2" BSPP
ILX1008PBLO/16	0-16 bar	1/2" BSPP
ILX1008PBLO/25	0-25 bar	1/2" BSPP
ILX1008PBLO/40	0-40 bar	1/2" BSPP
ILX1008PBLO/60	0-60 bar	1/2" BSPP
ILX1008PBLO/100	0-100 bar	1/2" BSPP
ILX1008PBLO/160	0-160 bar	1/2" BSPP
ILX1008PBLO/250	0-250 bar	1/2" BSPP
ILX1008PBLO/315	0-315 bar	1/2" BSPP
ILX1008PBLO/400	0-400 bar	1/2" BSPP
ILX1008PBLO/700	0-700 bar	1/2" BSPP



**TECH  
DATA**

### Pressure Gauge Accessories

Part #	Description
BB5-4450.000	Flange for 4" gauges (flange fitted on request)
BB3-4450.004	Flange for 2.5" gauges (flange fitted on request)
BB1-4450.000	Flange for 1.5" gauges (flange fitted on request)
BA5-4450.002	Stirrup for 4" gauges
BA3-4450.000	Stirrup for 2.5" gauges
BA1-4450.001	Stirrup for 1.5" gauges
AZ3-0000.004	Rubber gauge cover 2.5"
AZ5-0000.000	Rubber gauge cover 4.0"



**TECH  
DATA**

### Universal Pressure Gauge Kits

Part #	Analogue Gauges	Digital Gauge
CBOXMEDS1-M	1 x 0-100 bar, 1 x 0-400 bar	-
CBOXMEDDS-400	1 x 0-100 bar, 1 x 0-400 bar	0-400 bar
CBOXMEDDS-700	1 x 0-100 bar, 1 x 0-400 bar	0-700 bar

Included in all above kits:	Description		
Test hose	Test 20 female - 2 metres		
Direct gauge connector	1/4" BSPP female	<->	Test 20 male
Direct gauge connector	1/4" BSPP female	<->	Test 20 female
Anti-shock direct gauge connector	1/4" BSPP female 90°	<->	1/4" BSPT male
Anti-shock direct gauge connector	1/4" BSPP female straight	<->	1/4" BSPT male
Test point	1/4" BSPP male	<->	Test 20 male
Test point	1/4" 18 NPTF male	<->	Test 20 male
Test point	M10 x 1 male	<->	Test 20 male
Test point	M14 x 1.5 male	<->	Test 20 male
Test point	7/16" 20 UNF	<->	Test 20 male
Reducing adaptor	M10 x 1 female	<->	3/8" BSPP male
Reducing adaptor	M10 x 1 female	<->	1/2" BSPP male



CBOXMEDS1-M



CBOXMEDDS-400/700



CBOXMED3-M

**TECH  
DATA**

### Pressure Gauge Kit

Part #	Kit Includes:	Description
CBOXMED3-M	Pressure gauges x3	1 x 40 bar, 1 x 160 bar, 1 x 300 bar
	Test hose	Test 20 female - 2 metres
	Gauge adaptor x3	Test 20

**TECH  
DATA**

### Test Couplings (M16x2)

Part #	Thread		Seal Type	Diagram
S10718G00C	1/8" BSPP	Male	Elastomer	1
S10714G00C	1/4" BSPP	Male	Elastomer	1
S10414G00C	1/4" BSPP	Male	Metal	2
S10738G00C	3/8" BSPP	Male	Elastomer	1
S10438G00C	3/8" BSPP	Male	Metal	2
S10712G00C	1/2" BSPP	Male	Elastomer	1
S10818280C	1/8" BSPT	Male	-	5
S10814190C	1/4" BSPT	Male	-	5
S10838190C	3/8" BSPT	Male	-	5
S10410X10C	M10x1	Male	Elastomer	1
S10612X15C	M12x1.5	Male	Elastomer	1
S10614X15C	M14x1.5	Male	Elastomer	1
S10616X15C	M16x1.5	Male	Elastomer	1
S10134X16C	3/4" UNO	Male	O-ring	6
S10171X20C	7/16" UNO	Male	O-ring	6
S10191X18C	9/16" UNO	Male	O-ring	6
S10918270C	1/8" NPTF	Male	-	5
S10914180C	1/4" NPTF	Male	-	5
S10938180C	3/8" NPTF	Male	-	5
S11507163C	7/16" JICFS	Female	-	3
S11509163C	9/16" JICFS	Female	-	3
S11506163C	3/4" JICFS	Female	-	3
S115116FSC	11/16" ORFS	Female	-	3
S115131FSC	13/16" ORFS	Female	-	3
S115914G0C	1/4" BSPP	Female	-	3
S115916FSC	9/16" ORFS	Female	-	3
S11707162C	7/16" JIC Bulkhead	Male	-	4
S11709161C	9/16" JIC Bulkhead	Male	-	4

**MINIPRESS**  
MADE IN EUROPE

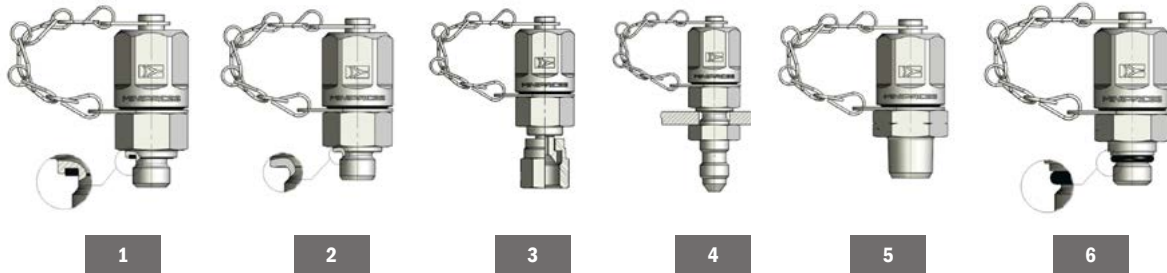

**TECH  
DATA**

### Pressure Gauge Isolators

Part #	Thread
ES180	1/4" BSPT straight
ES090	1/4" BSPT 90°

**MINIPRESS**  
MADE IN EUROPE



**TECH  
DATA**

### Pressure Gauge Adaptors

Part #	Description
20140000	Test 20 female to 1/4" BSPP gauge adaptor female swivel
20120000	Test 20 female to 1/2" BSPP gauge adaptor female swivel
21140000	90° 1/4" BSPP gauge adaptor female swivel to test 20 male
21120000	90° 1/2" BSPP gauge adaptor female swivel to test 20 male
18140000	1/4" BSPP gauge adaptor to test 20 male bulkhead
18120000	1/2" BSPP gauge adaptor to test 20 male bulkhead
1814M000	1/4" BSPP swivel gauge adaptor to 1/4" BSPP male
1812M000	1/2" BSPP swivel gauge adaptor to 1/2" BSPP male
1814MBSPT	1/4" BSPP swivel gauge adaptor to 1/4" BSPT male
1812MBSPT	1/2" BSPP swivel gauge adaptor to 1/2" BSPT male
24GG0000	90° test 20 female swivel to test 20 male
40GD0000	Test 20 male to test 20 male

 Test 20 is M16 x2

  
MADE IN EUROPE



20140000  
20120000

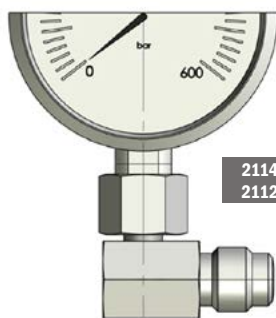

21140000  
21120000

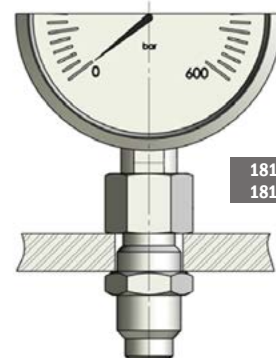

18140000  
18120000

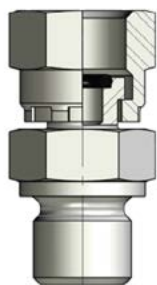

1814M000  
1812M000



1814MBSPT  
1812MBSPT

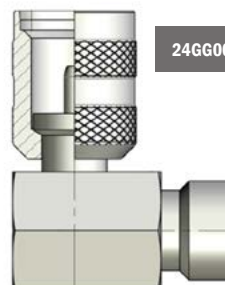

24GG0000



40GD0000

**TECH  
DATA**

### Hose Assembly

Part #	Description
THA-500	Test hose assembly 500mm test 20 ends
THA-1000	Test hose assembly 1000mm test 20 ends
THA-1500	Test hose assembly 1500mm test 20 ends
THA-2000	Test hose assembly 2000mm test 20 ends
THA-2500	Test hose assembly 2500mm test 20 ends
THA-3000	Test hose assembly 3000mm test 20 ends
THA-4000	Test hose assembly 4000mm test 20 ends
THA-5000	Test hose assembly 5000mm test 20 ends
THA-6000	Test hose assembly 6000mm test 20 ends

 Test 20 is M16 x2



  
MADE IN EUROPE

**TAIL 1**

**RD2  
(length)**

**TAIL 2**



 *Hose assembly charge applies*

**TECH DATA**

**Hose**

Part #	Type	ID	OD	Max Pressure	Burst Pressure	Temperature
00RSD200	RD2	2mm	5mm	630 bar	1890 bar	-40/+100 °C

**TECH DATA**



**Ferrules**

Part #	Type	Material	Max Pressure
30BT2000	RD2	Steel	600 bar
30BT2A10	RD2	Stainless	600 bar





**TECH DATA**

**Tails - Test Coupling**

Part #	Thread	Material	Type	Straight	45°	90°
31TTN600	M16x2	Steel	Straight			
31TTN6A10	M16x2	Stainless	Straight			
31TTN640	M16x2	Steel	45°			
31TTN690	M16x2	Steel	90°			

**TECH DATA**

**Tails - Gauges Threaded Fitting**

Part #	Thread	Material	Type	Straight	45°	90°
36140000	1/4" gauge	Steel	Straight			
3614A100	1/4" gauge	Stainless	Straight			
36120000	1/2" gauge	Steel	Straight			
36140040	1/4" gauge	Steel	45°			
36120040	1/2" gauge	Steel	45°			
36140090	1/4" gauge	Steel	90°			
36120090	1/2" gauge	Steel	90°			

**TECH  
DATA**

### Tails - 60° Cone Connection BSPP

Part #	Thread	Material	Type	Straight	45°	90°
38180000	G 1/8"	Steel	Straight			
38140000	G 1/4"	Steel	Straight			
38380000	G 3/8"	Steel	Straight			
38180040	G 1/8"	Steel	45°			
38140040	G 1/4"	Steel	45°			
38180090	G 1/8"	Steel	90°			
38140090	G 1/4"	Steel	90°			

**TECH  
DATA**

### Tails - 24° Cone Connection Type DKOL

Part #	Thread	Material	Type	Straight	45°	90°
35R00000	M12x1.5	Steel	Straight			
35R20000	M14x1.5	Steel	Straight			
35R50000	M16x1.5	Steel	Straight			
35R60000	M18x1.5	Steel	Straight			
35R00040	M12x1.5	Steel	45°			
35R20040	M14x1.5	Steel	45°			
35R50040	M16x1.5	Steel	45°			
35R00090	M12x1.5	Steel	90°			
35R20090	M14x1.5	Steel	90°			
35R50090	M16x1.5	Steel	90°			

**TECH  
DATA**

### Tails - ORFS Female Thread

Part #	Thread	Material	Type	Straight	45°	90°
5991F000	9/16-18" UNF	Steel	Straight			
5991F040	9/16-18" UNF	Steel	45°			
5991F090	9/16-18" UNF	Steel	90°			



**TECH  
DATA**

### Tails - JIC 74° Cone Connection Type DKJ

Part #	Thread	Material	Type	Straight	45°	90°
39160000	7/16-20" UNF	Steel	Straight			
3916AI00	7/16-20" UNF	Stainless	Straight			
3991J000	9/16-18" UNF	Steel	Straight			
39160040	7/16-20" UNF	Steel	45°			
39160090	7/16-20" UNF	Steel	90°			

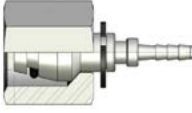

**TECH DATA**

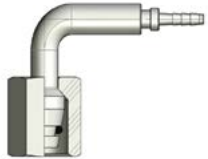
**Tails - 24° Cone Connection Type DKOLL**

Part #	Thread	Material	Type	Straight	45°	90°
46R00000	M8x1	Steel	Straight			
46R10000	M10x1	Steel	Straight			
46R10040	M10x1	Steel	45°			
46R10090	M10x1	Steel	90°			

**TECH DATA**

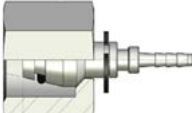
**Tails - 24° Cone Connection Type DKOS**

Part #	Thread	Material	Type	Straight	45°	90°
35R10000	M14x1.5	Steel	Straight			
35R30000	M16x1.5	Steel	Straight			
35R40000	M18x1.5	Steel	Straight			
35R70000	M20x1.5	Steel	Straight			
35R10040	M14x1.5	Steel	45°			
35R30040	M16x1.5	Steel	45°			
35R40040	M18x1.5	Steel	45°			
35R10090	M14x1.5	Steel	90°			
35R30090	M16x1.5	Steel	90°			
35R40090	M18x1.5	Steel	90°			

**TECH DATA**

**Tails - BSPP 60° Cone Connection**

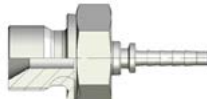
Part #	Thread	Material	Type	
44MFM180	G 1/8"	Steel	Straight	
44MFM140	G 1/4"	Steel	Straight	

**TECH DATA**

**Tails - BSPP with WD Seal**

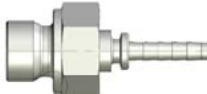
Part #	Thread	Material	Type	
44MFD180	G 1/8"	Steel	Straight	
44MFD140	G 1/4"	Steel	Straight	

**TECH DATA**

**Tails - BSPT**

Part #	Thread	Material	Type	
44MFC180	R 1/8"	Steel	Straight	
44MFC140	R 1/4"	Steel	Straight	

**TECH  
DATA**

### Pressure Switches

Part #	Pressure Range	Max Pressure	Thread	Voltage	Contact
4010116	50-150 bar	450 bar	1/8" BSPT	< 48v	NO
4010117	100-300 bar	450 bar	1/8" BSPT	< 48v	NO
4020116	50-150 bar	450 bar	1/8" BSPT	< 48v	NC
4020117	100-300 bar	450 bar	1/8" BSPT	< 48v	NC
4110110	0.1-1 bar	150 bar	1/8" BSPT	< 48v	NO
4110112	1-10 bar	150 bar	1/8" BSPT	< 48v	NO
4110113	10-20 bar	150 bar	1/8" BSPT	< 48v	NO
4110114	20-50 bar	150 bar	1/8" BSPT	< 48v	NO
4120110	0.1-1 bar	150 bar	1/8" BSPT	< 48v	NC
4120112	1-10 bar	150 bar	1/8" BSPT	< 48v	NC
4120113	10-20 bar	150 bar	1/8" BSPT	< 48v	NC
4120114	20-50 bar	150 bar	1/8" BSPT	< 48v	NC

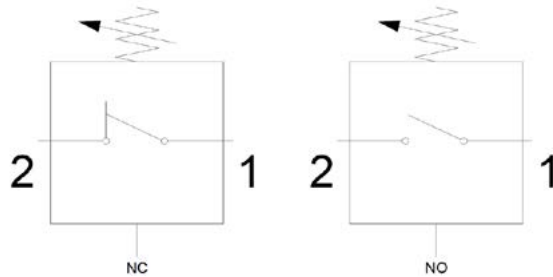
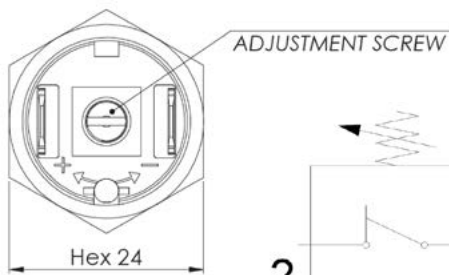

**TECH  
DATA**

### Pressure Switch Accessories (to suit series above)

Part #	Description
3015001	Rubber protective cap for pressure switch IP65
3900001	Plastic protective cap for pressure switches IP65
3900200	Plastic protective cap for pressure switches w/ DIN plug IP65

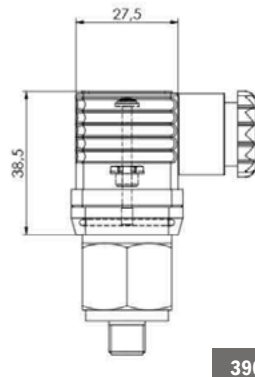
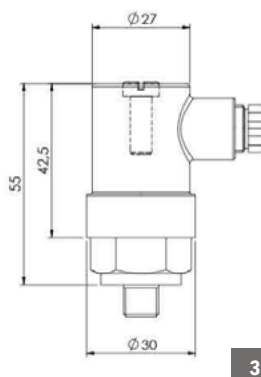
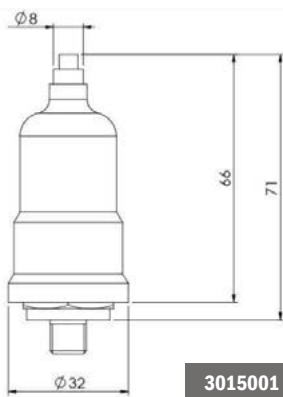

**TECH DATA**

**Pressure Switches**

Part #	Pressure Range	Thread	Voltage	Contact
69223015	8-160 bar	1/4" BSPPF	< 250v	NO/NC
69223016	40-400 bar	1/4" BSPPF	< 250v	NO/NC

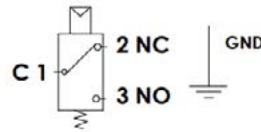
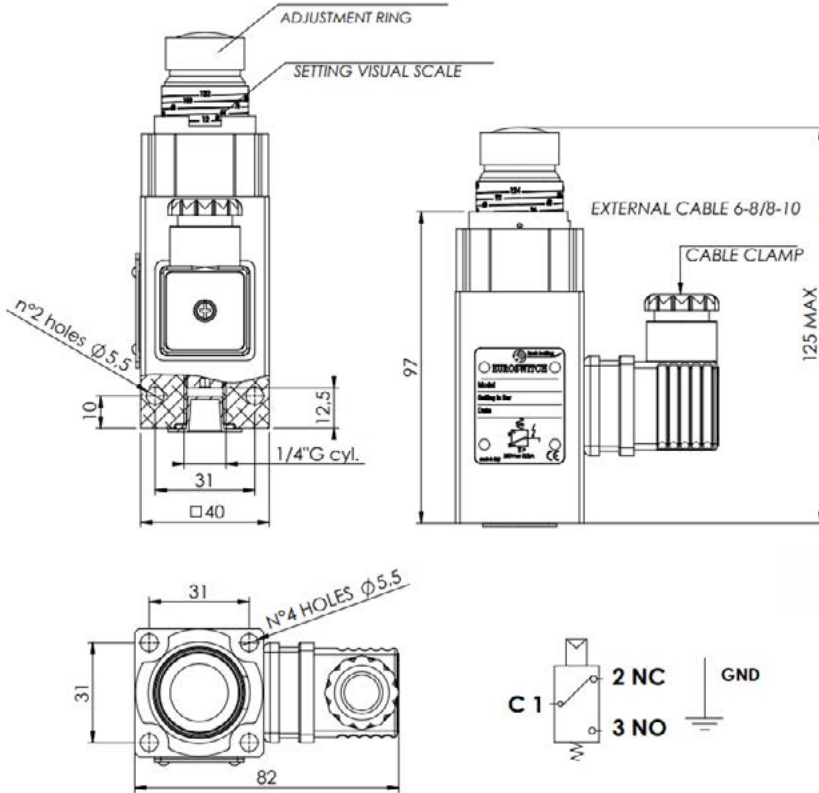

**TECH DATA**

**Pressure Switches**

Part #	Pressure Range	Maximum Pressure	Ports	Weight
DNA-100K-22B	15-100 bar	250 bar	1/4" BSPP	1.1 kg
DNA-250K-22B	40-250 bar	400 bar	1/4" BSPP	1.1 kg
DNA-360K-22B	50-360 bar	400 bar	1/4" BSPP	1.1 kg

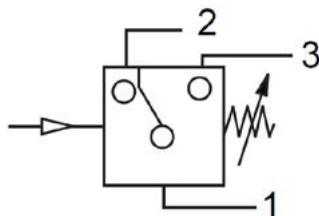
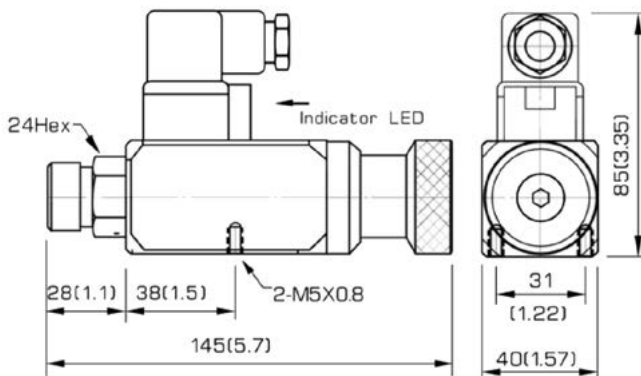



## MELBOURNE

**ADDRESS**

23 Quinlan Rd, Epping, VIC 3076

**EMAIL**

[sales@hydraulicsnetwork.com.au](mailto:sales@hydraulicsnetwork.com.au)

**PHONE**

03 9399 8957

## VERMONT

**ADDRESS**

5/137-145 Rooks Rd, Vermont, VIC 3133

**EMAIL**

[salessev@hydraulicsint.com.au](mailto:salessev@hydraulicsint.com.au)

**PHONE**

03 9874 1155

## BRISBANE

**ADDRESS**

19 Silvio St, Richlands, QLD 4077

**EMAIL**

[salesqld@hydraulicsnetwork.com.au](mailto:salesqld@hydraulicsnetwork.com.au)

**PHONE**

07 3277 5969

## PERTH

**ADDRESS**

2/44 Vinnicombe Dr, Canning Vale, WA 6155

**EMAIL**

[saleswa@hydraulicsnetwork.com.au](mailto:saleswa@hydraulicsnetwork.com.au)

**PHONE**

08 6385 3555

[www.hydraulicsnetwork.com.au](http://www.hydraulicsnetwork.com.au)