



OIL SOLUTIONS

PO Box 38
Strathfieldsaye, VIC, 3551
1800 OIL SOL
1800 645 765
sales@oilsolutions.com.au
www.oilsolutions.com.au
"For All Your Hydraulic Needs"



ESCLUSORI PER MANOMETRI
E MANOMETRI

GAUGE ISOLATORS
AND PRESSURE GAUGES



DATI TECNICI

Materiali: corpo in ghisa
 cursore in acciaio
 pulsante in materia plastica
 targhetta in alluminio
 guarnizione in gomma nitrilica

Pressione max: 400 bar
 Temperatura: -30°C → +100°C
 Peso: 0,610 kg

TECHNICAL DATA

Materials: cast iron body
 steel spool
 plastic button
 aluminium name plate
 nitrilic rubber seal

Max pressure: 400 bar
 Temperature range: -30°C → +100°C
 Weight: 0,610 kg

CODICE DI ORDINAZIONE / HOW TO ORDER

Serie Series		Tipo di azionamento Operation	
HB1	Esclusore 1 via Gauge isolator	PA	Pulsante a pressione / Attacco a vite Push button / Screw attachment
		PAF	Pulsante a pressione / Attacco a flangia Push button / Flange attachment
		RAF	Attacco a flangia / Selettore rotante Flange attachment / Rotary selector

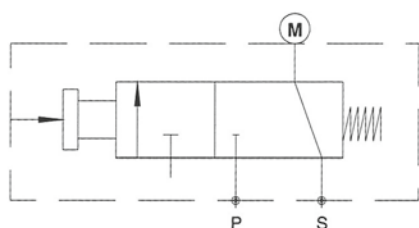
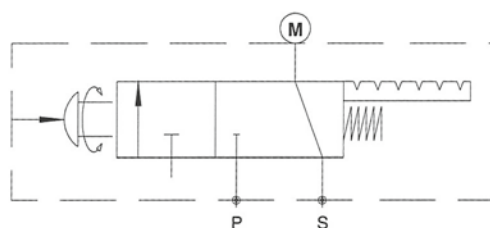
SIMBOLOGIA / SIMBOLS

HB1-PA
HB1-PAF

HB1-RAF

DESCRIZIONE

I selettori a 6 vie svolgono la medesima funzione già indicata per gli esclusori di manometro. Essi vengono utilizzati per collegare successivamente più punti del circuito ad un solo manometro.

DESCRIPTION

6 stations pressure selectors have the same function already indicated for gauge isolators. They are used to connect one by one different parts of the hydraulic circuit to one single pressure gauge.

DATI TECNICI

Materiali: corpo in ghisa
 cursore in acciaio
 targhetta, flangia d'attacco fondello in alluminio
 guarnizione in gomma nitrilica
 pulsante in materia plastica

Pressione max: 400 bar
 Temperatura: -30°C → +100°C
 Peso: 1,810 kg

TECHNICAL DATA

Materials: cast iron body
 steel spool
 aluminium name plate, connecting flange, end cover
 nitrilic rubber seal
 plastic push button

Max pressure: 400 bar
 Temperature range: -30°C → +100°C
 Weight: 1,810 kg

CODICE DI ORDINAZIONE / HOW TO ORDER

HB6

Serie
Series

HB6 | Selettori a 6 vie
6 station press, selector

SIMBOLOGIA / SIMBOLS

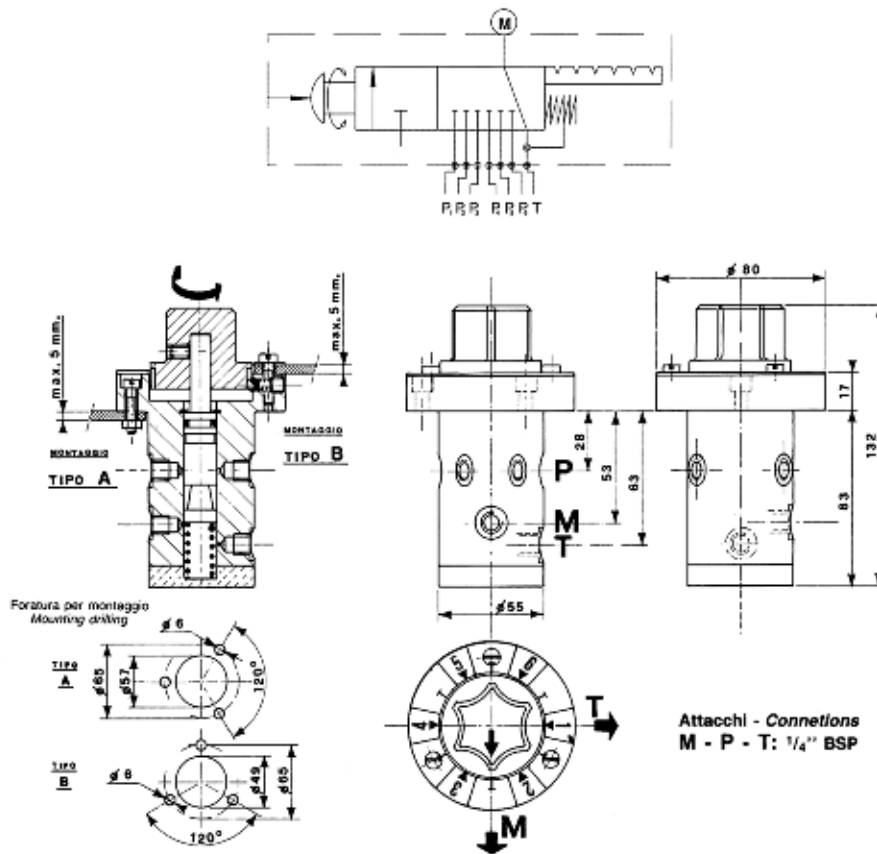

MANOMETRI
PRESSURE GAUGES
DESCRIZIONE

I manometri di questa serie sono manometri a bagno di glicerina e vengono forniti in due grandezze dimensionali:

- Ø 63 mm e attacco 1/4" BSP
- Ø 100 mm e attacco 1/2" BSP

DATI TECNICI

Materiali: cassa in acciaio inox AISI 300
 corpo in ottone
 fluido in riempimento glicerolo 98%
 vetro in vedril trasparente

Campo di temperatura: -10°C → +60°C

DESCRIPTION

These are glycerine filled pressure gauges and can be supplied in two different nominal sizes:

- Ø 63 mm and 1/4" BSP connection
- Ø 100 mm and 1/2" BSP connection

TECHNICAL DATA

Materials: stainless steel case (AISI 300)
 brass body
 glycerine filled 98%
 vedril type glass

Temperature range: -10°C → +60°C

CODICE DI ORDINAZIONE / HOW TO ORDER

Serie Series	MA <input type="checkbox"/>	63 - 25	Fondo scala Scale bar
Attacco / Connection		Grandezza nominale / Nominal size	
R Radiale - Radial		63 Ø 63 mm	25
A Assiale - Axial		100 Ø 100 mm	60
F Flangia - Flange			100
			160
			250
			400
			600

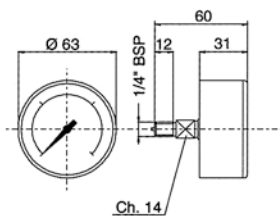
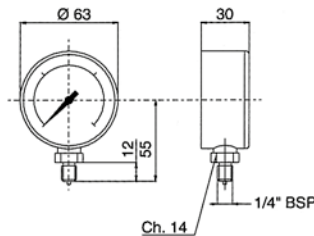
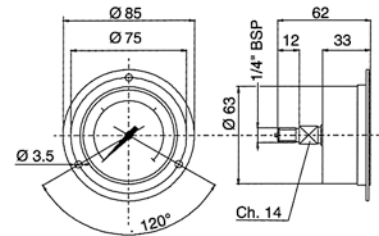
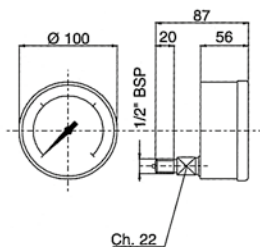
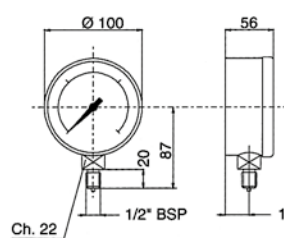
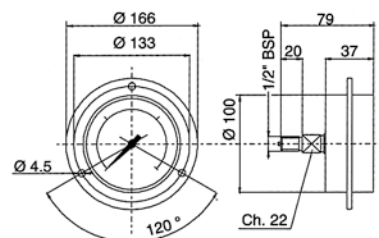
Assiale / Axial
MAA-63

Radiale / Radial
MAR-63

Flangia / Flange
MAF-63

Assiale / Axial
MAA-100

Radiale / Radial
MAR-100

Flangia / Flange
MAF-100

Pesi / Weight (kg)

MAA-63	MAR-63	MAF-63	MAA-100	MAR-100	MAF-100
0,240	0,220	0,260	0,630	0,630	0,700

MANOMETRI PRESSURE GAUGES

DESCRIZIONE

Manometro a secco, disponibile in grandezza nominale 40 (Ø 40 mm).
Scala 0÷12 bar - cassa in ABS - vetro in plexiglass.
Peso 0,070 kg.

Dry pressure gauge 1 size 40 (Ø 40 mm).
Scale 0÷12 bar - ABS body - plexiglass cover.

Weight 0,070 kg.

Assiale / Axial PV1

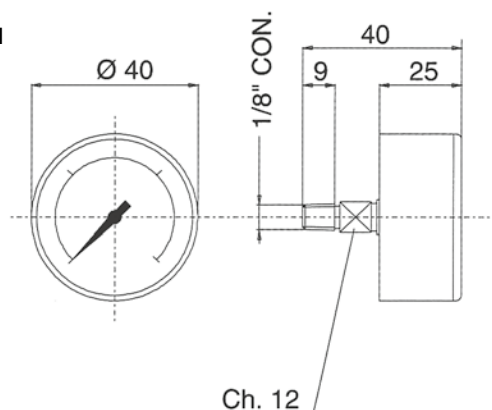

VV1

VUOTOMETRI VACUUM GAUGES

DESCRIZIONE

Vuotometro a secco grandezza nominale 40 (Ø 40 mm).
Scala da 0 a meno 76 cm/Hg.
Scala divisa in 3 settori colorati.
Cassa in ABS vetro plexiglass.
Peso 0,070 kg.

Dry vacuumgauge size 40 (Ø 40 mm).
Scale from 0 to -76 cm/Hg.
3 coloured sector scale.
ABS body - plexiglass cover.
Weight 0,070 kg.

Assiale / Axial VV1

